

Pistol Grip Air Screwdrivers

Stall

20 & 50 Series

Legendary performance in a compact, lightweight package with a well-deserved reputation for durability.

Features

- Torque range: 12 – 120 in-lbs (1.4 – 13.6 Nm)
- Speeds: 800 – 2,600 rpm
- Skinsulate housing provides comfortable grip surface
- One-handed reverse lever
- Torque adjusted by limiting air pressure
- Recommended for soft pull applications not requiring critical torque control

Service and Accessories

Manuals:

	49999035	20 Series
	49999093	50 Series









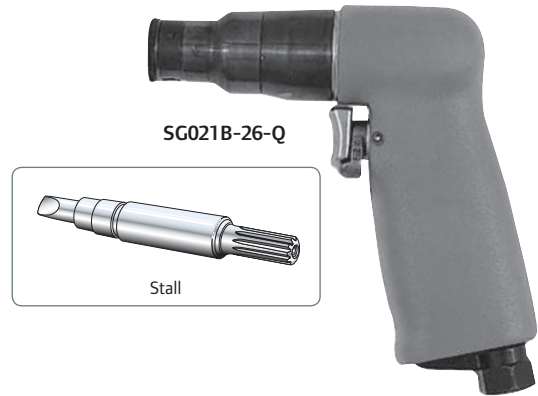





Accessories (20 Series and 50 Series):

Torque arm: QTA010
 Dead handle: 728N-A48
 Spring balancer, see page 177
 Spindle accessories, see page 183
 Suspension bail (20 Series): 47795
 Suspension bail (50 Series): 46472

Kits:

Service kit (20 Series): 46992
 Service kit (50 Series): 47353



Model	 in-lbs (Nm)	 rpm	 lbs (kg)	 in (mm)	 in (mm)	 in	 cfm (L/min)
20 SERIES TRIGGER START							
SG021B-26-Q	12 (1.4)	2,600	1.3 (0.6)	4.6" (118)	0.7" (17)	1/4" 	15 (420)
SG021B-15-Q	25 (2.8)	1,500	1.4 (0.6)	5.0" (128)	0.7" (17)	1/4" 	15 (420)
SG021B-9-Q	38 (4.3)	900	1.4 (0.6)	5.0" (128)	0.7" (17)	1/4" 	15 (420)
50 SERIES TRIGGER START							
SG051B-25-Q	45 (4.0)	2,500	2.2 (1.0)	6.9" (175)	0.8" (21)	1/4" 	25 (720)
SG051B-17-Q	65 (7.3)	1,700	2.4 (1.1)	7.4" (187)	0.8" (21)	1/4" 	25 (720)
SG051B-10-Q	90 (10.2)	1,000	2.4 (1.1)	7.4" (187)	0.8" (21)	1/4" 	25 (720)
SG051B-8-Q	120 (13.6)	800	2.4 (1.1)	7.4" (187)	0.8" (21)	1/4" 	25 (720)

Series			
20	76 dBa	1/4" NPT	5/16" (8 mm)
50	78 dBa	1/4" NPT	5/16" (8 mm)

Angle Air Nutrunners

Stall

20 Series

Legendary performance in a compact, lightweight package.

Features

- Torque Range: 17 – 27 in-lbs (1.9 – 3.0 Nm)
- Speeds: 1,000 – 1,750 rpm
- Compact, lightweight design
- Multiple drive sizes available
- Torque control through pressure regulation or operator control
- Recommended for soft pull applications not requiring critical torque control

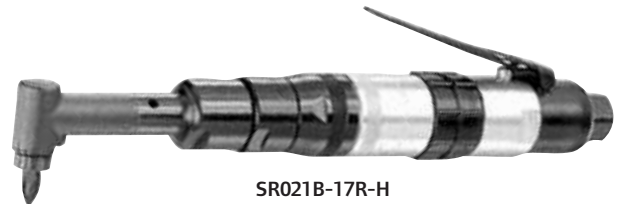

SR021B-17R-H

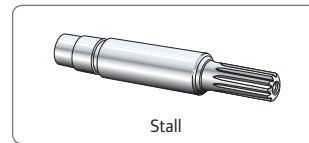

Stall

Service and Accessories

Manuals:

49999043

Accessories:

Spring balancer: BLD1
Spindle accessories, see page 183

Kits:

Service kit: 48803-1

Model	in-lbs (Nm)	rpm	lbs (kg)	in (mm)	in (mm)	in (mm)	in
LEVER START							
SR021B-17R-H	17 (1.9)	1750	1.7 (0.8)	9.5" (241)	0.6" (15.0)	1.5" (38.1)	1/4"
SR021B-10R-H	27 (3.0)	1,000	1.8 (0.8)	9.9" (252)	0.6" (15.0)	1.5" (38.1)	1/4"
LEVER START WITH PUSH BUTTON REVERSE							
SRB21A-17-H	17 (1.9)	1,750	1.7 (0.8)	9.5" (241)	0.52" (13.2)	1.5" (38.1)	1/4"
SRB21A-17-P	17 (1.9)	1,750	1.7 (0.8)	9.5" (241)	0.52" (13.2)	1.8" (45.7)	1/4"

Series				
20	76 dBA	1/4" NPT	5/16" (8 mm)	15 cfm (420 L/min)