

## AGXV-540, AGXV-541, AGXV-542 & AGXV-543 AUTOMATIC SPRAY GUNS

**IMPORTANT:** Before using this equipment, read **SAFETY PRECAUTIONS** starting on page 2.

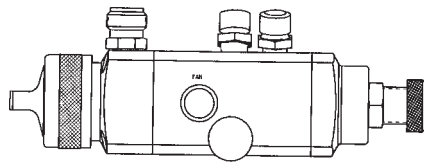

### DESCRIPTION

The AGXV high volume, low pressure spray gun (spray pistol) is used on automatic and semi-automatic machines where mass production spraying is necessary, or hand spraying is not accurate enough. Models and application information follows. All models are designed to provide maximum transfer efficiency by **limiting air cap pressure to 10 psi (0.7 bar) (in the U.S., this complies with rules issued by SCAQMD and other air quality authorities)**. Air cap pressure can be measured with an optional air cap test kit. See "ACCESSORIES" on Page 8.

### CHART 1 MODELS

Model No. (Available Tip Sizes)	Typical Applications	HVLP Air Cap Used	Fluid Tip/Needle Construction
AGXV-540 (E, FF, FX)	Most common finishing materials including some waterborne and chlorinated.	28 or 33A	400 Gr. S/S 303 Gr. S/S
AGXV-541 (D, E, FF, FX)	High solids (low VOC's) coatings which are difficult to atomize with HVLP, or high flow rates.	46MP or 83MP	400 Gr. S/S 303 Gr. S/S
AGXV-542 (FF, FX)	Waterbornes and other corrosive materials (below 7pH)	28 or 33A	303 Gr. S/S, Poly.
AGXV-543 (FF, FX)	Same as AGXV-541 except for more corrosive materials (below 7pH)	46MP	303 Gr. S/S, Poly.

### CHART 2 AIR CAPS – PATTERNS – APPLICATION

Air Cap No.	Complete Air Cap No.	*Typical Pattern Size and Shape	Typical Application
28	JGHV-101-28	11" (280 mm) long, straight sided, similar to 704 air cap.	Most common finishing materials, up to 12 oz./min. (360 cc)
33A	JGHV-101-33A	9" (229 mm) long, tapered ends, similar to 30 air cap.	
46MP	JGHV-101-46MP	11" (280 mm) long, straight sided, similar to 704 air cap.	Low VOC materials, 12 to 16 oz./min. (360 to 480 cc)
83MP	JGHV-101-83MP	13" (330 mm) long, straight sided similar to 765 air cap.	Low VOC materials, 17 oz./min. (510 cc) and above.

\* Actual pattern length dependent upon fluid tip (nozzle) ID, coating material flow rate, air pressure and fan pressure.

Most finishing materials can be atomized with either the 28 or 33A air caps. The 28 or 33A caps should be used where possible as they consume less air volume (CFM) and have slightly better transfer efficiency than the 46 MP or 83MP air caps. However, more difficult to atomize materials (i.e. low VOC's) or high flow applications over 12 oz./min. (360 cc/min.), are ideal for the 46 MP maximum performer air cap, fluid tip and baffle combination. Also available is the 83MP (maximum performer) for even higher flows 17 oz./min. (510 cc/min.) and above and higher viscosities. Refer to the air cap chart for more information.

### Note

This gun may be used with chlorinated solvents. Aluminum is not used in fluid passages. If using chlorinated solvents, make sure all other fluid handling components are also compatible.

A list of materials used in the construction of this equipment is available upon request.

### SPECIFICATIONS

P1 – Maximum Inlet Pressure – 100 PSI (7 bar)  
 P2 – Maximum Fluid Pressure – 100 psi (7 bar)  
 P3 – Cylinder Air Pressure  
 – Min. \*\*50 psi (3.5 bar)  
 – Max. 100 psi (7 bar)

Weight without mounting stud – 26 oz. (738 g)  
 Weight with mounting stud – 30.5 oz. (865 g)  
 Mounting stud diameter – 3/4" (19 mm)  
 Wetted Parts – 300 and 400 S/S, Teflon, Poly.  
 (See Chart 2 for tip/needle information)  
 Hose Connections –  
 Fluid Inlet – 3/8" NPS(M)  
 Cylinder Air – 1/4" NPS(M)  
 Atomization Air – 1/4" NPS(M)

### Note

For HVLP operation (max. 10 psi, - 0.7 bar cap pressure), do not exceed the air inlet pressure given below.

PSI (bar)	Cap No.
57 (4)	83MP
50 (3.4)	46MP
45 (3.1)	33A
38 (2.6)	28

\*\* For installations where 50 psi (3.4 bar) cylinder air is not available, the inner (red) piston spring can be removed which lowers the minimum cylinder air to approximately 37 psi (2.5 bar). Refer to "OPERATION", Pg. 4

### FLUID TIP (NOZZLE) ORIFICE SIZES

	Inch	mm
D	.086"	2.2
E	.070"	1.8
FF	.055"	1.4
FX	.042"	1.1
G	0.028	.7

### SAFETY PRECAUTIONS

This manual contains important information that ALL users should know and understand BEFORE using the equipment. This information relates to USER SAFETY and PREVENTING EQUIPMENT PROBLEMS. To help you recognize this information, we use the following terms to draw your attention to certain equipment labels and portions of this manual. Pay special attention to any label or information that is highlighted by one of these terms:



**Important information to alert you to a situation that might cause serious injury or loss of life if instructions are not followed.**





**Important information that tells how to prevent damage to equipment.**

**Note**



Information that you should pay special attention to.



**The following hazards may occur during the normal use of this equipment. Please read the following chart.**

HAZARD	CAUSE	SAFEGUARDS
<p><b>Fire</b></p> 	<p>Solvents and coatings can be highly flammable or combustible, especially when sprayed.</p>	<ol style="list-style-type: none"> <li>1. Adequate exhaust must be provided to keep the air free of accumulations of flammable vapors.</li> <li>2. Smoking must never be allowed in spray area.</li> <li>3. Fire extinguishing equipment must be present in the spray area.</li> <li>4. Static discharges must be prevented. Ground (earth) all conductive objects in the spray area, such as a cleaning solvent bucket, fire extinguisher, etc.</li> <li>5. When using solvents for cleaning:                             <ul style="list-style-type: none"> <li>•Those used for equipment flushing must have a flash point equal to or greater than that of the coating.</li> <li>•Those used for general cleaning must have flash points above 100°F (37.8°C).</li> </ul> </li> </ol>
<p><b>Inhaling Toxic Substances</b></p> 	<p>Certain materials may be harmful if inhaled, or if there is contact with the skin.</p>	<ol style="list-style-type: none"> <li>1. Follow the requirements of the Material Safety Data Sheet supplied by coating material manufacturer.</li> <li>2. Adequate exhaust must be provided to keep the air free of accumulations of toxic materials.</li> <li>3. Use a mask or respirator whenever there is a chance of inhaling sprayed materials. The mask must be compatible with the material being sprayed and its concentration. Equipment must be as prescribed by an industrial hygienist or safety expert, and be NIOSH approved.</li> </ol>
<p><b>Explosion Hazard – Incompatible Materials</b></p> 	<p>Halogenated hydrocarbon solvents- for example: methylene chloride and 1,1,1,- Trichloroethane are not chemically compatible with the aluminum that might be used in many system components. The chemical reaction caused by these solvents reacting with aluminum can become violent and lead to an equipment explosion.</p>	<p>The AGXV spray gun (spray pistol) can be used with these solvents. However, aluminum is widely used in other spray application equipment – such as material pumps, cups, regulators, valves, etc. Check all other equipment items before use and make sure they can also be used safely with these solvents. Read the label or data sheet for the material you intend to spray. If in doubt as to whether or not a coating or cleaning material is compatible contact your material supplier.</p>
<p><b>General Safety</b></p>	<p>Improper operation or maintenance may create a hazard.</p>	<p>Operators should be given adequate training in the safe use and maintenance of the equipment (in accordance with the requirements of NFPA-33, Chapter 15 in U.S.). Users must comply with all local and national codes of practice and insurance company requirements governing ventilation, fire precautions, operation, maintenance and housekeeping (in the U.S., these are OSHA Sections 1910.94 and 1910.107 and NFPA-33).</p>

**SAFETY PRECAUTIONS (Cont'd)**

HAZARD	CAUSE	SAFEGUARDS
<p><b>Noise Levels – Ear Injury</b></p> 	<p>A continuous A-weighted sound pressure level of this spray gun (spray pistol) may exceed 85 dB(A) depending on the air cap/fluid head setup being used. Sound levels are measured using an impulse sound level meter and analyzer, when the gun is being used in a normal spraying application.</p>	<p>Always wear ear protection when using the gun.</p> <p>Details of actual noise levels produced by the various air cap/fluid head setups are available upon request.</p>
<p><b>Solvent Spray</b></p> 	<p>During cleaning and flushing, solvents can be forcefully expelled from fluid and air passages. Some solvents can cause eye injury.</p>	<p>Wear eye protection.</p>
<p><b>Misuse:</b></p> <ul style="list-style-type: none"> <li>• All spray guns (spray pistols) project particles at high velocity and must never be aimed at any part of the body.</li> <li>• Never exceed the recommended safe working pressures for any of the equipment used.</li> <li>• The fitting of non-recommended or non-original accessories or spare parts may create hazardous conditions.</li> <li>• Before dismantling the equipment for cleaning or maintenance all pressure, air and materials, must be isolated and released.</li> </ul> <p>The disposal of waste materials must be carried out in an approved manner. Burning may generate toxic fumes. The removal or waste solvents and coating materials should be carried out by an authorized local waste disposal service.</p>		

**FIGURE 1 DIMENSIONS**

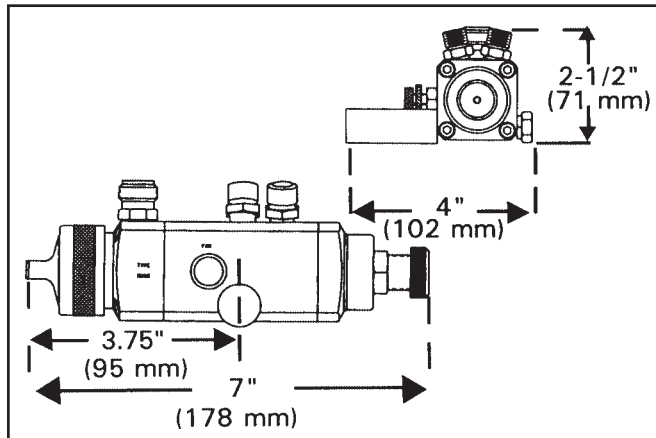

**INSTALLATION**

Mount the gun with the stud (13) or on a 5/16" dia. rod tightening adequately with the 1/4-28 X 1/4" set screws (Ref. 24). See "ACCESSORIES" for mounting clamps.

**Note**

If replacing the atomization air connection (15) with an elbow type connection, be aware of a possible air flow (CFM) limitation. A 1/4" (6.4 mm) I.D. 90° elbow will only pass 20 CFM @ 40 psi (566 l/min. 2.7 bar). Some air caps require more than 20 CFM (566 l/min.). Spray performance could be affected.

**FIGURE 2 TYPICAL INSTALLATION**

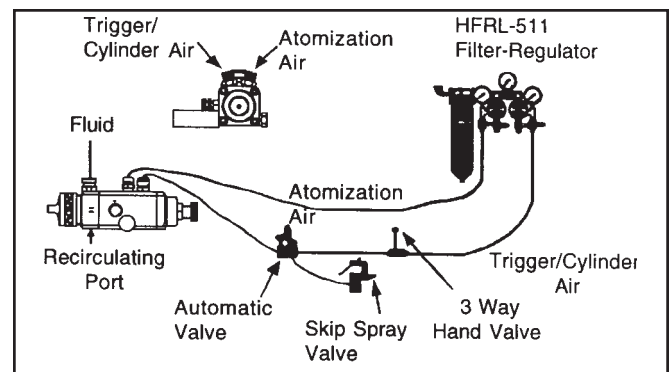

Attach the trigger/cylinder air hose and the atomization air hose to the connections as indicated by the markings on the gun body. The air supply should be filtered and regulated. Attach the material hose to the fluid inlet on the gun body. Fluid can be recirculated by installing a fluid fitting (AGX-415) (order separately) at the recirculating port. See **Caution** below.

**CAUTION**

**The fluid inlet and recirculating ports have a tapered seating surface intended for use with the AGX-415 fitting. Do not substitute other fittings as fluid leakage will occur.**

**OPERATION**

- Mix, prepare and strain the material to be sprayed according to the paint manufacturer's instructions. Use a lint free mesh to strain the material.
- Turn on the cylinder air at source of supply. Supply air should be a minimum of 50 PSI (3.5 bar). For constant operation the pressure should be regulated. If 50 psi (3.5 bar) cylinder air pressure is not available, the red inner spring (31) can be removed. This allows a minimum cylinder pressure of approximately 37 psi (2.6 bar).

**Note**

If the red inner spring (31) is removed, atomization pressure should not exceed 70 psi (4.8 bar) (will result in gun not shutting off).

- Turn the needle adjustment knob (25) counterclockwise several turns. With the cylinder air on, turn the adjustment knob (25) clockwise until it contacts piston (19) (for maximum fluid flow). Back knob out 1/2 turn.

**Note**

Due to close part tolerances, actuate the gun on and off 7 or 8 times to "break-in" the packings. Do this with the material supply off.

- Adjust the atomization air pressure to 50 PSI (3.5 bars) or less. Always attempt to keep the pressure as low as possible to minimize overspray. The fluid pressure should be between 10 to 15 PSI (0.7 to 1.0 bar).
- Open the hand valve and/or trip the automatic valve if installed in the system and observe the spray pattern. Adjust the air and fluid pressures until the desired pattern is obtained. Control the fluid pressure at the source of supply. If the desired regulation is not practical at this point, restrict the flow by turning the adjustment knob (25) clockwise.

**Back Pressure – 46MP and 83MP "Maximum Performer"**

Due to the unique cone shape of the MP fluid tips (nozzle), a slight back pressure is created against the fluid column. This will reduce the amount of fluid output. To compensate, increase the fluid regulator pressure slightly if necessary. With 10 PSI (0.7 bar) cap pressure, back pressures are approximately 3.5 PSI (0.24 bar) with the 46MP and 2.0 PSI (0.14 bar) with the 83MP.

- The width of the spray pattern is controlled by the adjusting valve (23) marked "FAN". With the "FAN" valve screwed fully clockwise, the spreader air will be closed off causing a round pattern. By gradually opening this valve, the pattern changes to a fan spray. The width is determined by the amount the valve is opened. Atomization air is adjusted by regulating the supply air to the gun.

Adjustments to fan may be controlled remotely by using the optional KK-4955 fan control adapter to replace the AGG-403 control valve (23). A separate solenoid valve is required to control on/off function. See Figure 2A.

- Close the automatic valves and begin operation.

**FIGURE 2A AIR CIRCUIT EXAMPLE WITH OPTIONAL KK-4955 REMOTE FAN CONTROL**

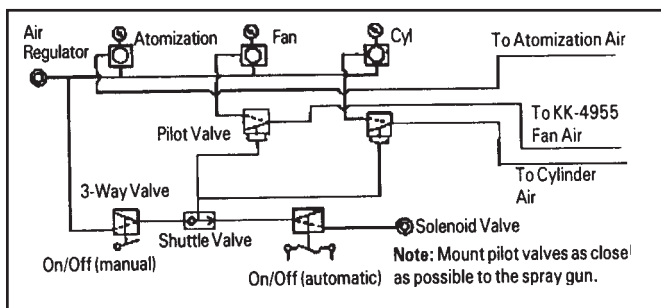

**CHART 3 FLUID TIPS (NOZZLE) AND NEEDLES**

Tip Size	If this No. on Tip ORDER →	Fluid Tip & Needle Set
<b>400 Gr. Stainless Steel Tip/303 Stainless Steel Needle</b>		
	<b>In mm</b>	
E .070"	1.8	AV-2115-E AGX-4402-E
FF .055"	1.4	AV-2115-FF AGX-4402-FF
FX .042"	1.1	AV-2115-FX AGX-4402-FX
G .028"	0.8	AV-2115-G AGX-4402-G
FF .055"	1.4	AV-2120-FF AGX-4600-FF*
FX .042"	1.1	AV-2120-FX AGX-4600-FX*
D .086"	2.2	AV-2120-D AGX-4483-D**
E .070"	1.8	AV-2120-E AGX-4483-E**
<b>303 Gr. Stainless Steel, U.H.M.W. Poly.</b>		
E .070"	1.8	AV-4915-E AGX-4300-E
FF .055"	1.4	AV-4915-FF AGX-4300-FF
FX .042"	1.1	AV-4915-FX AGX-4300-FX
FF .055"	1.4	AV-4920-FF AGX-4613-FF*
FX .042"	1.1	AV-4920-FX AGX-4613-FX*
E .070"	1.8	AV-4920-E AGX-4613-E
D .086"	2.2	AV-4920-D AGX-4613-D

\* For use with 46MP air cap.  
 \*\* For use with 83MP air cap.

**PREVENTIVE MAINTENANCE**



**Risk of Injury. Equipment and fluid may be under pressure. Pressure in the system must be relieved before beginning the cleaning procedure and before replacing any parts. Follow the procedures in the literature provided with the system.**

**Cleaning**

- Relieve air pressure from the pressure feed tank. Carefully follow the instructions in the bulletin sent with the tank.
- Replace material in the container with a suitable solvent.
- Repressurize the system.
- Trigger the gun and repeat the procedure until the gun and hose are thoroughly clean (solvent is clean when it looks the same as when you first opened solvent container). A SolventSaver™ type hose and gun cleaner which supplies a mixture of air and solvent can be used to most effectively clean the gun and hose internal passages. See "Accessories" on back page. Wipe the exterior of the gun with a solvent dampened cloth.
- If a recirculating system is used, it may be necessary to fit a shut off valve in the return line to ensure the fluid tip and forward portion of the sprayhead passage are properly cleaned when flushed with solvent.



**Do not totally submerge the gun in solvent. It is possible to wash solids into the air operating sections of the gun which could damage piston "O" ring seals.**



**The air cap can be immersed in solvent for cleaning. If the orifices are clogged, use a broom straw or toothpick to remove the obstruction. Never use a steel wire or hard instrument. This will damage the air cap and result in a distorted spray pattern.**

## PARTS REPLACEMENT

### Tools Required:

Crescent Wrench or "C" Spanner  
 1/2" Box Wrench or 1/2" Socket Spanner (Ref. 3)  
 9/16" Open Wrench (Ref. 9) or 9/16" spanner  
 Long Neck Vise Grip Pliers (19) or long nose grips  
 Hex Wrench 1/8" for (Ref. 24)  
 Hex Wrench 3/16" for (Ref. 7)

### Fluid needle (28) , Tip (3) and Needle Packings (11)

1. Relieve all air and fluid pressure in the system.
2. Remove retaining ring (1) & air cap (2).
3. Remove fluid tip (3).



**To avoid serious gun damage, do not remove the fluid tip (nozzle) (3) from the spray gun (spray piston) when the fluid inlet adapter (6 or 9) is removed. Doing so may allow the stainless steel insert to break free from the aluminum body, which is non-repairable.**

4. It is recommended that both the fluid tip (nozzle) (3) and the needle (28) be replaced at the same time. The needle packings (11) should also be replaced when replacing the needle.
5. Remove adjusting knob (25).
6. Remove needle (28) with pliers.
7. Loosen four screws (7) and remove sprayhead (8).
8. With the sprayhead (8) removed, the packings (11) can be easily removed and replaced.
9. Slide onto the new needle (28), in this order, 1 packing (11), spring (12) and 1 packing (11). Be sure to orient the packings as shown (Figure 4).
10. Assemble sprayhead (8) with retaining screws (7).
11. Tighten screws (7) with a 3/16 hexagon key 30-40 in. lbs. (3.4 - 4.5 N-m) until the body is flush with sprayhead assembly.
12. Reassemble in reverse order.

### Piston (19) , O-Rings (17 & 18) and Air Packing (20)

1. Remove the back piece (29) by removing the rear retaining screws (7).
2. Remove fluid needle (28).
3. Remove springs (30, 31 & 27) and piston (19). Care must be taken when removing the piston (19). Use a locking long nose vice grip pliers to extract the piston by clamping on the inner ring on the back of the piston.
4. Remove the air packing (20), "O" rings (17 & 18).
5. Wipe clean the bore of the cylinder. Replace the piston "O" rings (17 & 18) and lightly lubricate with clean petroleum jelly. See "LUBRICATION" section which follows.
6. To replace air packing (20) (inside of the piston), slide packing (20) over the needle (28) with the lead-in chamfer towards the fluid tip (nozzle) end of the needle. Insert the needle into the piston (19). Hold the piston in your hand so that the tip end of the needle is protruding downward (protect the needle from damage). Lightly tap the blunt end of the needle to drive the packing down into the piston. The needle will stop inside the piston at a shoulder.
7. Fit complete assembly into gun.
8. Lubricate the outside of springs (31) and (27) (see "LUBRICATION" section), then re-install springs and back piece (29) and tighten down and torque mounting screws (7) 30-40 in. lbs. (3.4 to 4.5 N-m).
9. Lubricate the adjustment knob threads (25) after cleaning with •SSL-10 Gun Lube. Loosen the locking nut (26) before screwing the adjustment knob in.

•Material Safety Data Sheet available from DeVilbiss upon request.

### Plug (6) or Fluid Insert (9)



**Halogenated Hydrocarbon solvents can chemically react with aluminum. A risk of explosion or severe corrosion will occur. The following assembly step must be carefully performed.**

If replacing AGX-415 inlet fitting, or if it should loosen, follow the assembly procedures below, and refer to Figure 3.

1. If installing a used fitting, clean paint and thread sealant from the fitting threads and gun body.
2. Screw the jam nut all the way onto the fitting. Then apply a medium strength thread sealant (i.e. Loctite 242 blue, or equal) to the first few threads of the fitting.
3. Install the AGX-415 fitting into the spray gun and tighten to a maximum of 12 ft. lbs. (16.3 N-m) torque. (Do not overtighten, damage may occur.)
4. Tighten the jam nut to 16 ft. lbs. (21.7 N-m) torque using a thin 9/16" open end wrench.
5. Use two wrenches when removing a hose connection from AGX-415 to prevent the inlet fitting from loosening.

FIGURE 3

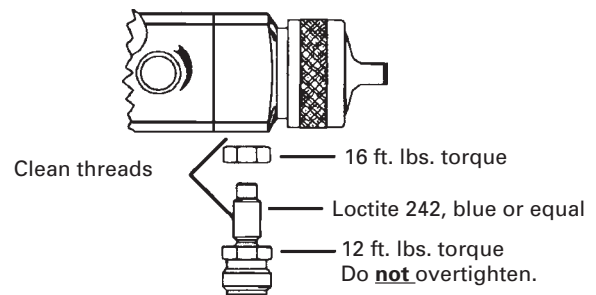

### LUBRICATION

The piston O-rings (17 and 18) must be lubricated when the piston (19) is removed. Lightly lubricate with clean petroleum jelly. Petroleum jelly is effective as a lubricant up to approximately 110°F (43°C). Above 110°F (43°C), petroleum jelly will become "liquid" and will not lubricate the O-rings adequately. If the ambient temperature adjacent to the spray gun exceeds 110°F (43°C), use Parker O-Lube or suitable high temperature grease. This allows the spray gun to be used in temperatures up to 150°F (65° C) continuous without lubrication degradation.

Lubricate the outside of the larger piston spring (30) and needle spring (27) with a light coating of non-silicone grease. Apply a thin film of petroleum jelly (petroleum based grease) to the fluid needle (28) as shown in the "Note" on Page 6.

### Note

Due to close part tolerances, after repairing the gun, actuate the gun on and off 7 or 8 times to "break-in" the air packing (20). Do this with the material supply off.

FIGURE 4 GUN ASSEMBLY

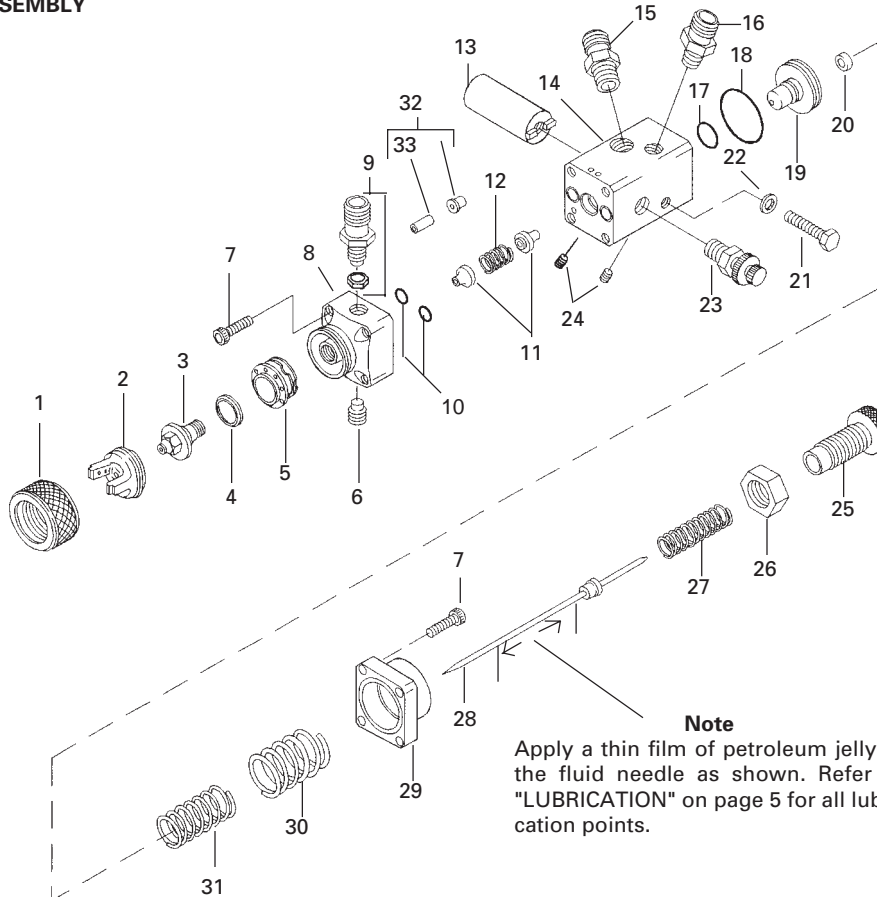

**PARTS LIST**

Ref. No.	Replacement Part No.	Description	Individual Parts Req.
1	MBC-368	Retaining Ring (plated brass)	1
	MSA-1	Retaining Ring (Delrin) (Optional)	1
* 2	See Chart 2	Air Cap	1
#* 3	See Chart 3	Fluid Tip (nozzle)	1
+* 4	AV-1-K5	Gasket	1
5	AGHV-403	Baffle	1
6	AGX-6-K3	Fluid Outlet Plug (Kit of 3)	1
7	SSF-3156-K4	Mounting Screw (Kit of 4)	8
8	AGXV-400	Sprayhead Assembly	1
9	AGX-415	Inlet Fitting & Jam Nut	1
+* 10	—	"O" Ring, Buna-N	2
+* 11	—	Needle Packing, Teflon	2
+* 12	—	Seal Spring	1
13	KK-4995	Gun Mounting Stud Kit (Includes Items 13, 21, 22 & 24)	1
14	AGX-11	Body	1
15	H-2008	Coupling 1/4 NPS(M) x 1/4 NPT(M)	1
16	H-1766	Coupling 1/4 NPS(M) x 1/8 NPT(M)	1
+* 17	—	"O" Ring, Thiokol	1
+* 18	—	"O" Ring, Thiokol	1
19	AGX-9	Piston	1
+* 20	—	Air Packing	1
21	—	Hex Hd. Cap Screw, 5/16-18 x 2-1/4	1
22	—	5/16 Lockwasher	1
23	AGG-403	Air Valve Assy. - Horn	1
24	—	1/4-28 x 1/4" Lg. Knurled cup point set screw	2
25	AGX-2-1-K3	Adjustment Knob (Kit of 3)	1
26	34215-122	Locknut	1
●* 27	—	Needle Spring	1
#* 28	See Chart 3	Fluid Needle Assembly	1
29	AGX-10	Back Piece	1
●* 30	—	Outer Piston Spring	1
●* 31	—	Inner Piston Spring (Red)	1
32	KK-5017	Abrasive Fluid Seal Kit (optional, includes 3 seals and 1 brass collar)	1
+ 33	—	Abrasive Fluid Seal (U.H.M.W. Poly.)	1

Detail Ref. No. 32 (Optional)

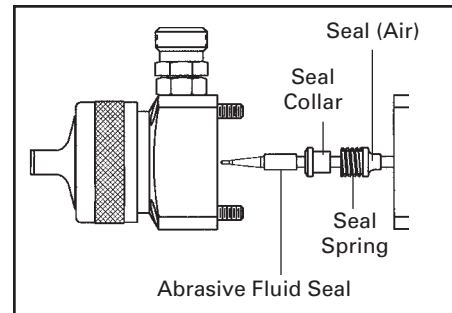

Torque Specifications		
Ref. No.	Torque Requirements	
	Inch or Ft. Lbs.	N-m
3	20-25 ft. lbs.	27.0 - 24.0
7	30-40 in. lbs.	3.4 - 4.5
6 & 9	12 ft. lbs.	16.3
21	220 in. lbs.	21.5 - 24.9
24	30 in. lbs.	3.4

- \* Recommended spare parts.
- + Parts included in KK-4992-1 Gun Repair Kit.
- # Order set, See Chart 2.
- Springs included in KK-4993 Spring Kit.

**TROUBLESHOOTING**



Proper gun adjustment will result in normal spray patterns, from round with the fan control valve (23) closed, to long and narrow with the valve open. Pattern width depends upon how much the valve is opened, the type of air cap used and fluid flow rate.







**NORMAL SPRAY PATTERN**

The proper combination of fluid pressure, fan and atomization air pressure, and fluid tip size should result in a pattern of this shape.

**TROUBLESHOOTING CHART**

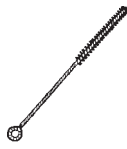
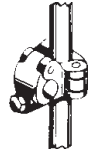
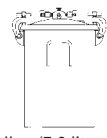
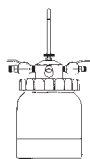
PROBLEM	CAUSE	CORRECTION
<b>Will not spray</b>	No pressure to gun. Piston stops moving. New air packing (20)	Check air and material lines. Check tightness of socket screws (7). Remove fluid needle (28) and lubricate with petroleum jelly and reassemble.
<b>Improper spray pattern</b>  	<b>A.</b> Gun not adjusted properly. <b>A, &amp; B.</b> Material build up on the air cap or fluid tip.  <b>C.</b> Wrong material or material too thick. <b>D.</b> Insufficient material or atomizing air pressure too high.	<b>A.</b> Re-adjust. See "Operation Section". <b>A, &amp; B.</b> Clean the air cap or fluid tip (nozzle). See "Preventive Maintenance".  <p style="text-align: center;"><b>Note</b></p> <p>To determine where the material build up is, rotate the air cap 180° and test spray. If the pattern stays in the same position, the condition is caused by material build up on the fluid tip (nozzle). If the pattern changes with air cap movement, the build up is in the air cap.</p> <b>C.</b> Adjust material pressure or thin material. <b>D.</b> Increase material or reduce atomizing air pressure.
<b>Jerky or fluttering spray</b>  	Insufficient material in the tank or an obstruction in the line.  Gun material passage plugged.  Worn packings (11).  Loose or damaged fluid tip.	Fill tank or clear obstruction.  Clean.  Replace.  Tighten or replace.
<b>Fluid leaking from needle packings (11).</b>	Needle packings (11) worn.  Rough or worn fluid needle shaft.	Replace.  Polish contact point where packings (11) makes contact with very fine emery cloth or replace tip (3) & needle (28).
<b>Dripping from fluid tip.</b>	Contamination (i.e. dried paint) in seating area of tip (3).  Worn or damaged fluid tip (3) or needle (28).  Piston springs (30) and/or (31) damaged or deformed.	Clean.  Replace.  Replace.
<b>Air Leakage from Control Valve (23)</b>	Worn Seals.	Replace Valve. (23).

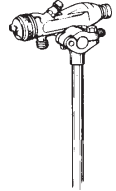
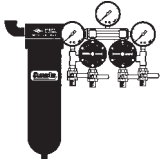
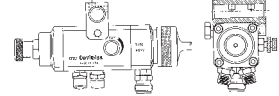
**ACCESSORIES**

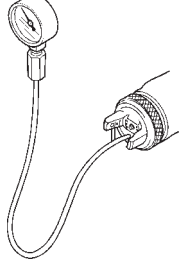
<p><b>42884-214-K5 3/8"</b> <b>42884-215-K10 5/8"</b> <b>Cleaning Brushes</b></p>  <p>These brushes are helpful in cleaning threads and recesses of gun body.</p>	<p><b>AGA-415</b> <b>Universal Clamp</b></p>  <p>Attaches to the gun stud (39), clamps onto a 19 mm (3/4") diameter rod and turns to any angles.</p>	<p><b>QMGZ-5200</b> <b>Hose/Gun Cleaner</b> <b>SolventSaver™</b></p>  <p>2 gallon (7.6 liters) galvanized tank used to clean the inside of hose and material passages of the gun. Available in U.S. only.</p>	<p><b>HD-503</b> <b>2 qt. (2.1 Liters)</b> <b>Hose/Gun Cleaner</b> <b>SolventSaver™</b></p>  <p>Used to clean the inside of hose and material passages of the gun.</p>	<p><b>SSL-10</b> <b>Spray Gun Lube</b> <b>2 oz. (60 ml) bottle</b></p>  <p>Use on air cap and retaining ring. Compatible with all paint materials, contains no silicone or petroleum distillates to contaminate paint. MSDS available upon request.</p>	<p><b>KK-4955</b> <b>Fan Control</b> <b>Adapter Kit</b></p>  <p>Used for adjusting pattern size from a remote air source.</p>									
<p><b>AGA-414</b> <b>Extension Rod Assembly</b></p> <table border="1"> <thead> <tr> <th></th> <th>In.</th> <th>mm</th> </tr> </thead> <tbody> <tr> <td>Rod Length</td> <td>16</td> <td>406</td> </tr> <tr> <td>Rod Diameter</td> <td>3/4</td> <td>19</td> </tr> <tr> <td>Clamp Diameter</td> <td>3/4</td> <td>19</td> </tr> </tbody> </table> 		In.	mm	Rod Length	16	406	Rod Diameter	3/4	19	Clamp Diameter	3/4	19	<p><b>HFRL-511 Filter-Regulator</b></p>  <p>Use in the line between the source of air supply and the gun for the purpose of extracting dirt and entrained water and oil. Will also enable users to regulate and control atomization air pressure to the gun.</p>	<p><b>KK-5046 Mounting Block Kit</b></p>  <p>Allows gun to be mounted on a 1/2" rod. Kit includes block and 4 stainless steel set screws.</p>
	In.	mm												
Rod Length	16	406												
Rod Diameter	3/4	19												
Clamp Diameter	3/4	19												
<p><b>JGA-156-K10</b> <b>Spring Clips</b></p>  <p>Joins any single piece DeVilbiss air cap with latest version MBC-368 or MSA-1 retaining ring. Helps prevent parts loss and provides easier assembly.</p>	<p><b>29-3100 Scrubs®</b> <b>Hand Cleaner Towels</b></p>  <p>Scrubs® are a pre-moistened hand cleaner towel for painters. No water is needed.</p>	<p><b>Air Cap Test Kits</b></p> <p>KK-5033-28 for JGHV-101-28 air cap          KK-5033-33A for JGHV-101-33A air cap.          KK-5033-46MP for JGHV-101-46MP          KK-5033-83MP for JGHV-101-83MP</p>  <p>The purpose of this test kit is to measure air cap atomizing air pressure. Used to confirm code compliance and as a daily quality control measure.</p>												

**Pressure Feed Tanks:** QMG/QMS Galvanized and Stainless Steel pressure feed tanks are intended for use as a pressure container to supply material at a constant preset pressure. 2, 5, 10 and 15 gallon models available.

**KK-5017 Fluid Seal Kit** – For use with abrasive materials. Includes 1 brass seal collar and 3 polyethylene fluid seals.

**WARRANTY**

This product is covered by DeVilbiss' 1 Year Limited Warranty.

**DeVilbiss Worldwide Sales and Service Listing: [www.devilbiss.com](http://www.devilbiss.com)**

**ITW Industrial Finishing**

DeVilbiss has authorized distributors throughout the world. For technical assistance or the distributor nearest you, see listing below.

**U.S./Canada Technical Service Office:**

195 Internationale Blvd., Glendale Heights, IL 60139  
 Toll-Free Telephone: 1-888-992-4657 (U.S.A. and Canada only)  
 Toll-Free Fax: 1-800-368-8401

