

Heating a paint booth shouldn't be difficult.  
It should be EZ.



## EZ Heat by Col-Met Spray Booths.

### STANDARD FEATURES

- Filter and inlet damper included
- Stand included with vertical units
- Inlet head included with horizontal units
- Unit function indicator lights

### COL-MET "EXCLUSIVES"

- Digital microprocessor
- Self-adjusting profile damper
- Motorized auto gas control
- High-efficiency plug type fan

### OPTIONS

- Cure cycle available
- Single-phase power available



**EZ Heat & Cure  
Control Panel Shown**

**COL-MET**  
*spray booths*  
expect more

## HORIZONTAL AMU UNIT

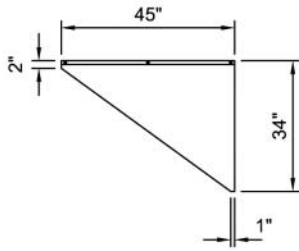

**INLET RAIN HOOD**

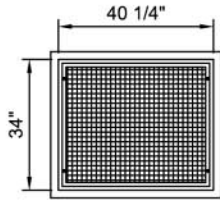

**AIR INLET**

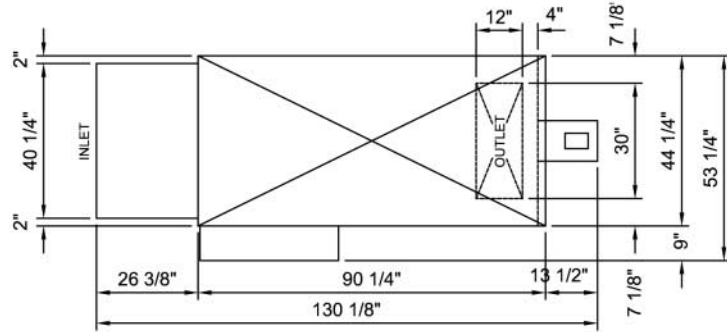

**PLAN VIEW**

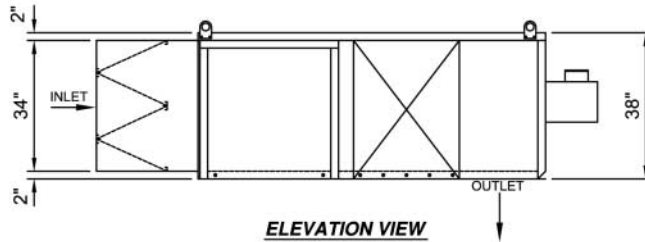

**ELEVATION VIEW**

## VERTICAL AMU UNIT

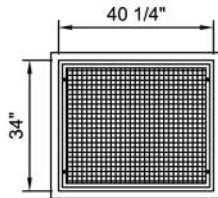

**AIR INLET**

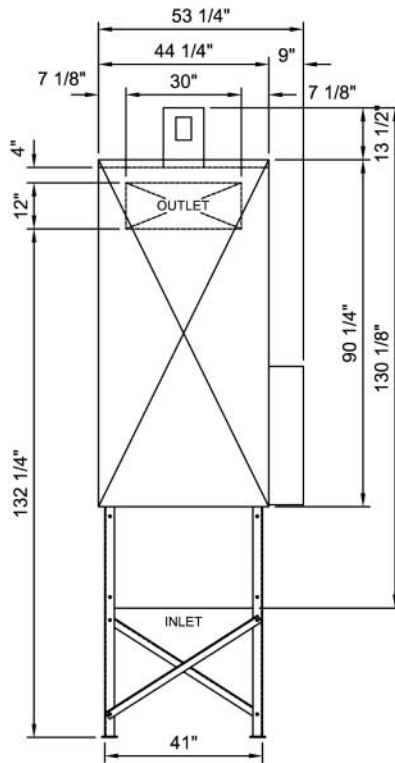

**SIDE VIEW**

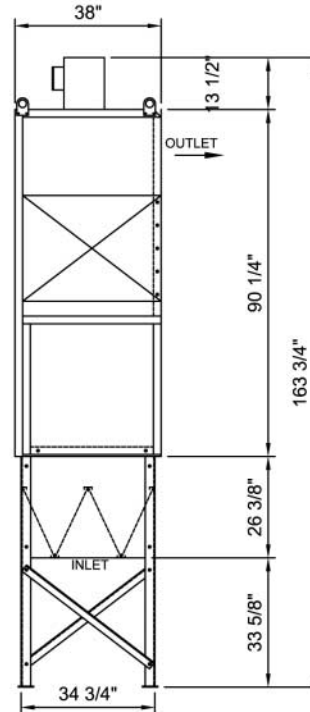

**FRONT VIEW**

### Col-Met Spray Booths, Inc.

Dallas, TX // e-mail: [sales@colmetsb.com](mailto:sales@colmetsb.com)

toll free: 888.452.6684 // [www.colmetsb.com](http://www.colmetsb.com)