

Atomization

Table of Contents

Introduction	1
<i>Module Overview</i>	1
<i>How to Use This Module</i>	1
Atomization Fundamentals.....	3
<i>Learning Objectives</i>	3
<i>Atomization, Sprays, Droplets, and Surface Tension</i>	3
<i>Fluid Properties Affecting the Spray</i>	5
Atomization Processes.....	9
<i>Learning Objectives</i>	9
<i>Pressure (Airless) Atomization.....</i>	9
<i>Air (Airspray) Atomization.....</i>	10
<i>Centrifugal Atomization</i>	11
<i>Electrostatic Atomization</i>	12
<i>Ultrasonic Atomization</i>	13
<i>Achieving Desired Atomization.....</i>	14

GRACO, INC.
P.O. Box 1441
Minneapolis, MN 55440-1441

©1995 Graco, Inc., Form No. 321-027 8/95 Printed in U.S.A.

Introduction

Welcome to *Atomization*, a learning module in Graco's basic concept and theory sales training curriculum. Your understanding of this information provides the basis for further study on specific Graco products. Your ability to successfully promote and sell Graco's products depends in part on how well you learn the basics and then apply this knowledge to addressing your customers' needs for Graco equipment.

While this curriculum best fits the requirements of Graco and distributor sales people, it will also benefit anyone whose job function depends on knowledge of Graco's products.

Module Overview

This module orients you to the process of atomization and describes five basic forms of atomization.

How to Use this Module

The curriculum consists of a series of self-study modules. As the term self-study implies, you work through the materials on your own at a comfortable pace. Plan sufficient time (approximately 30 minutes) to complete at least one section of a module in a working session.

This module combines a variety of features that makes the learning process convenient and productive:

- Learning objectives
- Text
- Charts, illustrations
- Progress checks
- Additional resources

Learning Objectives

Each section of material offers a set of learning objectives. Read the objectives and use them to guide you to the most important concepts. After you finish each section and before you complete the progress check, reread the objectives to confirm that you understand the key concepts.

Text

Definitions, examples, and explanations comprise the learning module text. Read it carefully and return for review if necessary.

Charts, Illustrations

An important element of any instruction is visualizing the concepts. This module contains graphics and illustrations to enhance the text material. Wherever appropriate, the module also contains charts that help you organize or summarize information.

Progress Checks

Progress checks are self-tests that provide reinforcement and confirm your understanding of important topics. After completing each section of the module, return to review the objectives, and then work through each of the progress check items. Upon completion, check your answers against those provided. If you answered any incorrectly, return to the text and reread the pertinent information.

Additional Resources

This module may refer you to other documents or sources that expand on the concepts covered in the module. The reference will include the name of the source and how you can obtain it.

Atomization Fundamentals

Learning Objectives

Your effectiveness with customers depends in part on your ability to knowledgeably and confidently discuss their needs, your products, and competitors products. The concepts of atomization form part of the foundation necessary for future learning about how guns operate and how to promote Graco's products' features and benefits. After completing this section on basic terms, you will be able to:

- Distinguish between atomization and sprays.
- Describe the property of liquid surface tension.
- Relate fluid properties to their effects on atomization.

Atomization, Sprays, Droplets, and Surface Tension

Atomization refers to the process of breaking up bulk liquids into droplets. Common home atomizers you may be familiar with include shower heads, perfume sprays, garden hoses, and deodorant or hair sprays. A classic example of atomization occurring naturally involves pouring liquid from a pitcher. As you are pouring and gradually lift the pitcher higher, the stream of liquid elongates and breaks into droplets at some point. This breakup of a liquid stream is a simplistic example of atomization. See Figure 1 for an illustration of this concept.

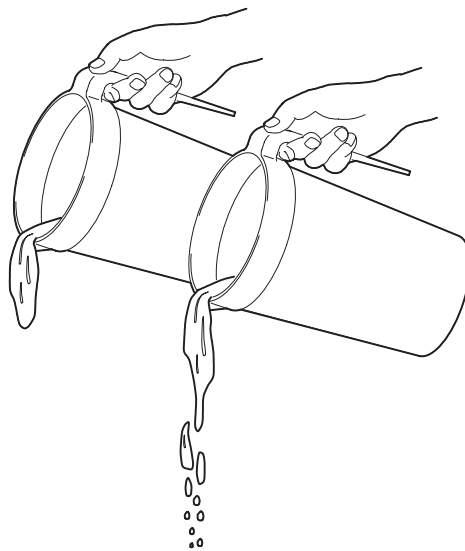
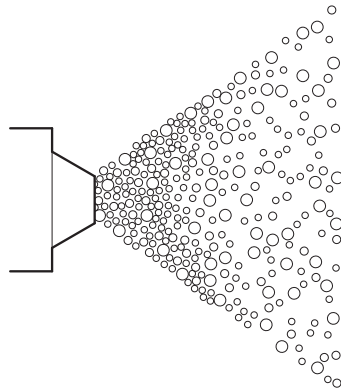

Figure 1 Atomization of a stream of liquid.

05016

A spray is a collection of moving droplets that usually are the result of atomization; they are moving in a controlled fashion. Naturally occurring sprays are rain and ocean sprays. See Figure 2 for a depiction of a spray from a gun. Note that there are a variety of droplet sizes in the spray.



05017

Figure 2 A spray stream with a variety of droplet sizes.

A droplet is a small particle of liquid having a more or less spherical shape. Droplets are also known as particles.

The reason particles are round is due to the liquid’s surface tension. Recall that surface tension is the property of a liquid that causes droplets and soap bubbles to pull together in a spherical form and resist spreading out. This property causes sheets or thin ligaments of liquid to be unstable; that is, they break up into droplets, or atomize.

Have you ever accidentally broken a thermometer and observed how mercury beads up? Mercury’s resistance to spreading out is evidence of its high surface tension. You also may have observed this phenomenon with water; it has a tendency to bead up into droplets, especially on a waxed surface, like a car. The chart in Figure 3 lists a number of common materials and their surface tensions.

As the temperature of a liquid increases, its surface tension generally decreases. This becomes an important factor when handling certain fluids.

Surface Tension of Common Fluids	
Liquid	Surface Tension (Newton/meter at 20°C)
Ethyl alcohol	0.022
Soapy water	0.025
Benzene	0.029
Olive oil	0.032
Lubricating oil	0.037
Glycerine	0.063
Water	0.073
Mercury	0.465

Figure 3 Surface tension of familiar liquids.

Fluid Properties Affecting the Spray

A variety of factors affect droplet size and how easily a stream of liquid atomizes after emerging from an orifice. Among these factors are fluid properties of surface tension, viscosity, and density.

Surface Tension

Surface tension tends to stabilize a fluid, preventing its breakup into smaller droplets. Everything else being equal, fluids with higher surface tensions tend to have a larger average droplet size upon atomization.

Viscosity

A fluid's *viscosity* has a similar effect on droplet size as surface tension. Viscosity causes the fluid to resist agitation, tending to prevent its breakup and leading to a larger average droplet size. Figure 4 represents the relationship among viscosity, droplet size, and when atomization occurs.

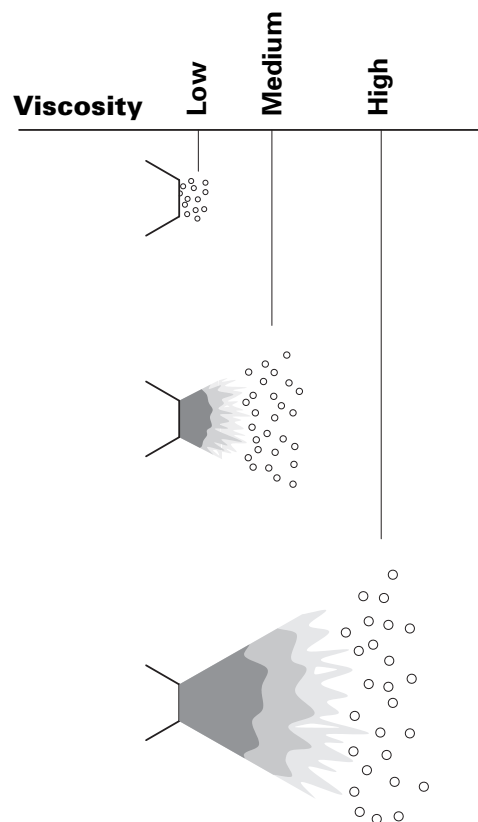

05018

Figure 4 Viscosity, droplet size, and when atomization occurs

Density

Density causes a fluid to resist acceleration. Similar to the properties of both surface tension and viscosity, higher density tends to result in a larger average droplet size.

Progress Check

Directions: After answering the following questions, compare your answers with those provided in the answer key following this progress check. If you respond to any items incorrectly, return to the text and review the appropriate topics.

For items 1-4, match the terms with their descriptions.

Terms

- a. Droplets
- b. Spray
- c. Atomization
- d. Surface tension

Descriptions

- ___ 1. A collection of a variety of sizes of fluid droplets moving in a controlled fashion
- ___ 2. Causes atomized liquid to break up into spherical droplets
- ___ 3. Small particles of liquid
- ___ 4. The process of breaking up liquids into droplets
- 5. Select the best description of the effect caused by surface tension.
 - a. A resistance to beading up
 - b. The tendency of liquids to form sheets or ligaments
 - c. The opposite of viscosity
 - d. The formation of spherical droplets

Answers to Progress Check

1. b. A **spray** is a collection a variety of sizes of fluid droplets moving in a controlled fashion
2. d. **Surface tension** causes an atomized liquid to break up into spherical droplets
3. a. **Droplets** are small particles of liquid
4. c. **Atomization** is the process of breaking up liquids into droplets
5. d. Surface tension is the force that causes fluids to pull together into spherical forms and resist the tendency to spread out

Atomization Processes

Learning Objectives

This section of the module lays the groundwork for future learning on how fluid handling equipment works. It is an orientation to the five different atomization processes of the spray coating industry:

- Pressure atomization*
- Air atomization*
- Centrifugal atomization*
- Electrostatic atomization
- Ultrasonic atomization

* **Note:** Graco builds pressure, air and centrifugal atomization equipment but not electrostatic or ultrasonic atomization equipment.

After completing this section on atomization processes, you will be able to:

- Define the five atomization processes.
- Identify the source of atomization energy for each process.
- Differentiate between electrostatic atomization and electrostatic spray charging.
- Explain the effect of viscosity and flow rate on atomization.

Pressure (Airless) Atomization

Other terms the spray coating industry uses for pressure atomization include airless, air-assisted airless, hydrostatic, and hydraulic technology.

In the airless atomization process, high pressure forces fluid through a small nozzle. The fluid emerges as a solid stream or sheet at a high speed. The friction between the fluid and the air disrupts the stream, breaking it into fragments initially and ultimately into droplets.

The energy source for this form of atomization is fluid pressure, which is converted to momentum as the fluid leaves the nozzle.

Three factors that affect an airless spray include the atomizer orifice diameter, the atmosphere, and the relative velocity between the fluid and the air. Regarding orifice diameter, the general rule is that the larger the diameter or size of the atomizer orifice, the larger the average droplet size in a spray.

The atmosphere provides resistance and tends to break up the stream of fluid. This resistance tends to overcome, in part, the fluid's properties of surface tension, viscosity, and density. In addition, the air temperature may also affect atomization.

The relative velocity between the fluid and the air also affects droplet sizes. The fluid's velocity is created by pressure in the nozzle. As the fluid pressure increases, velocity increases and the average droplet size decreases. And conversely, as fluid pressure decreases, velocity is lower and the average droplet size is larger.

Figure 5 illustrates a simple circular orifice injecting a round stream of fluid into the atmosphere. The fluid is under pressure and is breaking up into a spray.

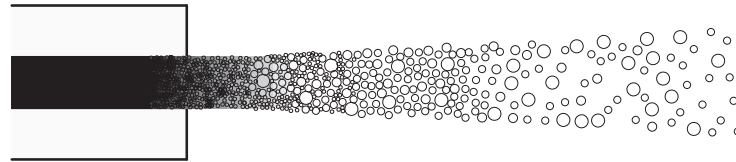

05020

Figure 5 Airless atomization with fluid under pressure

Air (Airspray) Atomization

In airspray atomization, fluid emerging from a nozzle at low speed is surrounded by a high speed stream of air. Friction between the liquid and air accelerates and disrupts the fluid stream and causes atomization.

The energy source for air atomization is air pressure. The operator can regulate the flow rate of fluid independently of the energy source. Figure 6 illustrates a stream of fluid passing through an orifice; as it emerges, a high speed stream of air surrounds the fluid stream. Note that other modules will cover the function of the horns you see on the illustration and the resulting spray patterns.

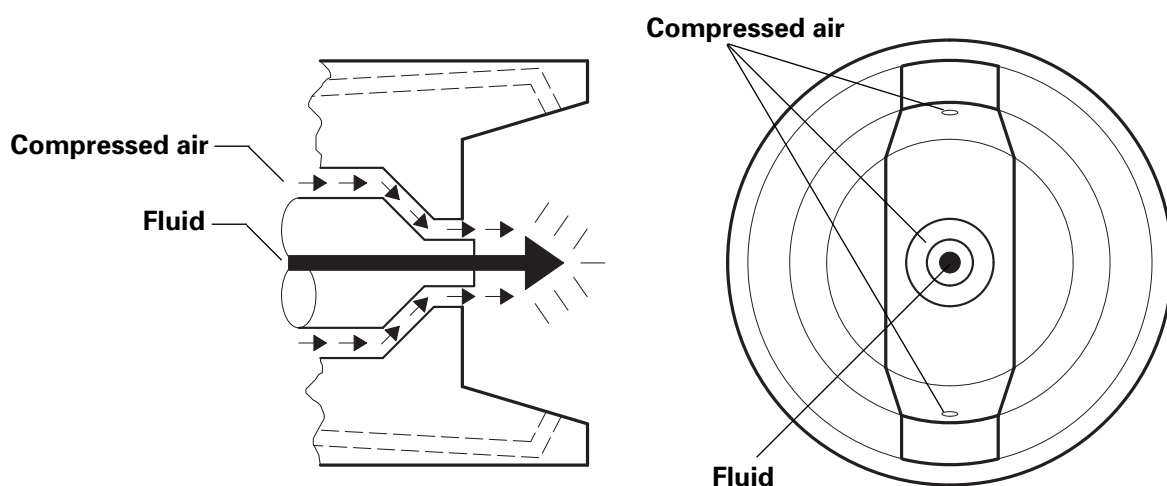

05021

Figure 6 Airspray atomization with high velocity air

Note that sometimes you will hear the term conventional instead of air atomization. Use of the word conventional is often ambiguous since many industry people use this term to refer to all nonelectrostatic applications.

Recall that it is the relative difference in velocity between fluid and air that causes atomization. Review the chart in Figure 7 for a summary of this concept for airless and airspray atomization. Then see Figure 8 which depicts a high-velocity water jet (airless atomization).

Relative Initial Velocity	Air	Fluid
Airless atomization	Slow	Fast
Airspray atomization	Fast	Slow

Figure 7 The relative velocities of air and fluid for airless and airspray atomization

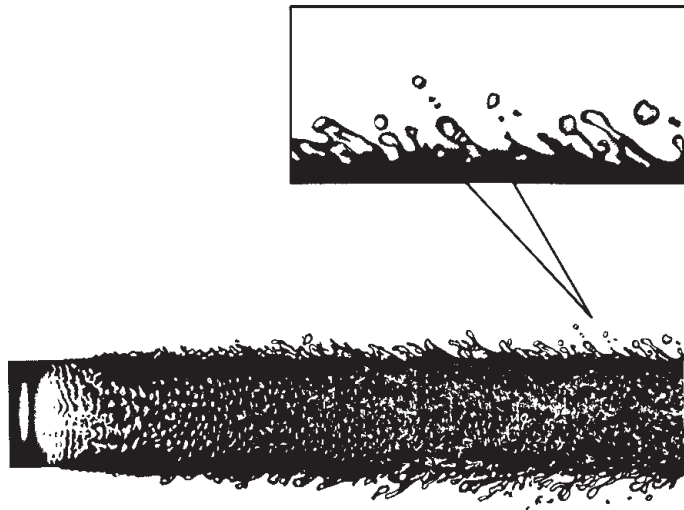

05019

Figure 8 A high-velocity water jet that is breaking up by airless atomization.

Centrifugal Atomization

In centrifugal or rotary atomization, a nozzle introduces fluid at the center of a spinning cup or disk. Centrifugal force carries the fluid to the edge of the disk and throws the fluid off the edge. The liquid forms ligaments or sheets that break into fine droplets. Figure 9 shows the mechanism of centrifugal atomization.

The energy source for rotary atomization is centrifugal force. With the same rotational speed, at low flow rates, droplets form closer to the edge of the disk than with higher flow rates. The spray pattern tends to move radially away from the disk or cup in all directions (360°).

With rotary atomization, operators can control both the flow rate and the disk speed independently of each other. In most spray coating rotary applications, electrostatic charge is applied to the spray to attract the droplets to a grounded target object. In some types of atomizers, such as bells, shaping air can be added to move the spray forward in an axial direction.

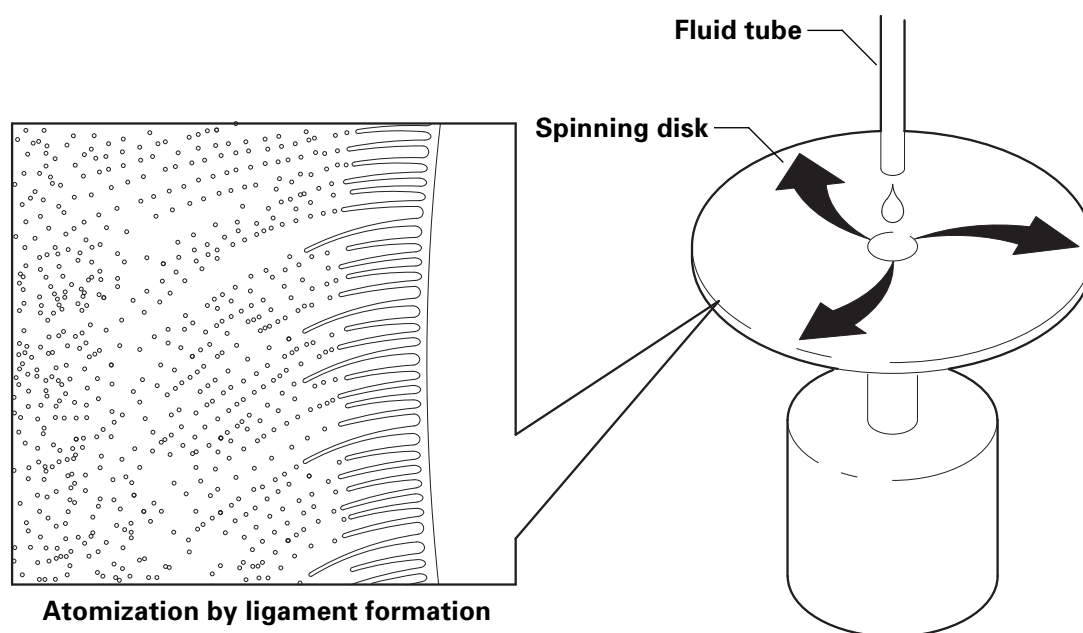

05022

Figure 9 Centrifugal atomization

Electrostatic Atomization

Electrostatic atomization exposes a fluid to an intense electric field between the charged atomizer and grounded work piece. The charge transfers to the fluid and repulsive forces between the atomizer and the fluid tear the droplets from the atomizer and send them toward the work surface. See Figure 10 for an illustration of the concept of electrostatic atomization.

The energy source for electrostatic atomization is the electric charge that the fluid receives. The particle size with electrostatic atomization is a function of three main factors:

- Electric field strength
- Liquid flow rate
- Fluid properties (including its electrical properties)

It is important to understand the distinction between electrostatic atomization and electrostatic spray charging. With electrostatic atomization, electrostatic forces are used to atomize the fluid. In electrostatic spray charging, the spray is usually atomized by airless, airspray, or rotary means, and electrostatic charge is applied to the droplets as they form to help attract them to the work surface.

Note, however, that electrostatic atomization is not successful for current high viscosity coatings.

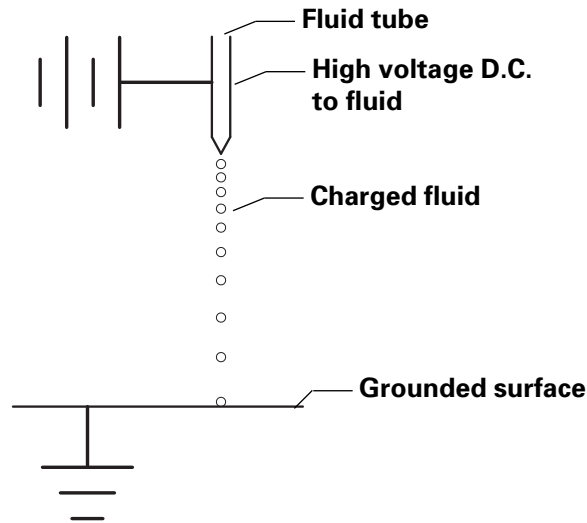

05023

Figure 10 Electrostatic atomization.

Ultrasonic Atomization

Although it is uncommon to find this atomization process in the spray coating industry, competitors periodically introduce new “ultrasonic” technologies. It is important to understand the process to evaluate new technologies and counter competitors’ claims effectively.

Ultrasonic atomization relies on an electromechanical device that vibrates at a very high frequency. Fluid passes over the vibrating surface and the vibration causes the fluid to break into droplets. Figure 11 shows an example of ultrasonic atomization technology.

Applications of this technology include:

- Medical nebulizers for inhalation therapy
- Drying liquids; powdered milk for example, in the food industry
- Surface coatings in the electronics industry

Ultrasonic atomization technology is effective only for low-viscosity Newtonian fluids. It has not been successfully commercialized for paint.

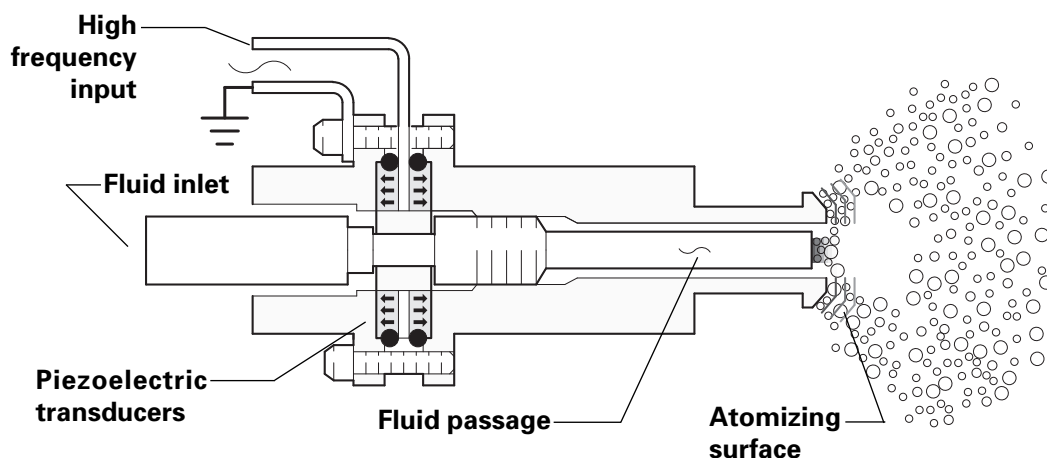

05024

Figure 11 Ultrasonic atomization technology.

Achieving Desired Atomization

Achieving the desired level of atomization requires maintaining a balance of the fluid viscosity and quantity (fluid flow rate) on one side with atomization energy on the other side. Figure 12 shows a fulcrum that schematically illustrates the necessary balance.

Once the system (or operator) achieves the desired level of atomization, a change in any parameter will affect the atomization. Balancing the equilibrium with an opposing change can return the atomization to the desired level.

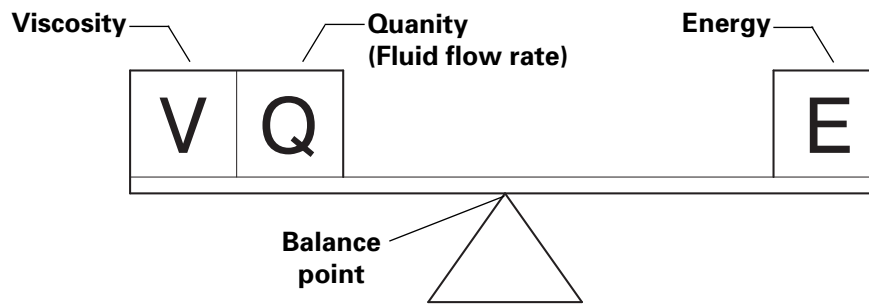

Figure 12 Balancing factors to achieve desired atomization.

05025

Review the chart in Figure 13 for a summary of the energy sources for the atomization processes used in Graco equipment.

Atomization Processes	Energy Sources
Pressure (airless, air-assisted airless)	Fluid pressure
Air (airspray)	Air pressure
Centrifugal (rotary)	Centrifugal force (motor)

Figure 13 Atomization processes and their energy sources.

Progress Check

Directions: After answering the following questions, compare your answers with those provided in the answer key following this progress check. If you respond to any items incorrectly, return to the text and review the appropriate topics.

For questions 1-4, match the atomization process with its description. In addition, write a G in the space next to the atomization processes used in Graco fluid handling equipment.

Atomization Processes

- a. Pressure (airless) _____
- b. Air (airspray) _____
- c. Centrifugal _____
- d. Electrostatic _____
- e. Ultrasonic _____

- ___ 1. Introduction of fluid to the center of a spinning disk; the fluid breaks up into fine droplets as it flows off the disk's edge
 - ___ 2. Passing fluid over a vibrating device that causes a breaking up of the fluid into droplets
 - ___ 3. Exposing a fluid to an electric field that tears the droplets from the atomizer and propels them toward the work surface
 - ___ 4. Forcing a fluid through an orifice at high speed; friction between the fluid and the air disrupts the fluid stream and breaks it up into droplets
 - ___ 5. A high pressure air stream that surrounds fluid under low pressure; friction disrupts the fluid stream and breaks it up into droplets
6. Describe the difference between electrostatic atomization and electrostatic spray charging.

7. To achieve desired atomization, what parameter must you change to balance increased viscosity or fluid flow rate?
- Equilibrium
 - The atomization process
 - Energy
 - Fluid density
8. Complete the chart by checking the boxes that characterize the appropriate droplet description for each factor listed.

Factor	Droplet Sizes Increase	Droplet Sizes Decrease
Increasing surface tension		
Increasing viscosity		
Increasing size of atomizer orifice		
Increasing fluid pressure		
Decreasing fluid pressure		

Answers to Progress Check

1. c (G) **Centrifugal** atomization is the introduction of fluid to the center of a spinning disk; the fluid breaks up into fine droplets as it flows off the disk's edge
2. e **Ultrasonic** atomization involves passing fluid over a vibrating devices that causes a breaking up of the fluid into droplets
3. d **Electrostatic** atomization exposes a fluid to an electric field that tears the droplets from the atomizer and propels them toward the work surface
4. a (G) **Pressure** atomization forces fluid through an orifice at high speed; friction disrupts the fluid stream and breaks it up into droplets
5. b (G) **Air** atomization employs a high pressure air stream that surrounds fluid under low pressure; friction disrupts the fluid stream and breaks it up into droplets
6. During electrostatic atomization, fluid droplets atomize as a result of an electric charge to the fluid. With electrostatic spray charging, the charge is applied to cause the fluid droplets to be attracted to a grounded target, while atomization is achieved by another method.
7. c To achieve desired atomization, increased viscosity or fluid flow rate must be offset or balanced by increased atomization energy.
8. The droplet sizes of fluids tend to increase or decrease according to the following chart:

Factor	Droplet Sizes Increase	Droplet Sizes Decrease
Increasing surface tension	✓	
Increasing viscosity	✓	
Increasing size of atomizer orifice	✓	
Increasing fluid pressure		✓
Decreasing fluid pressure	✓	

Module Evaluation

The purpose of this Module Evaluation is to help the Graco Technical Communications department determine the usefulness and effectiveness of the module.

Instructions: Please complete the evaluation, tear it on the perforation, and return it Graco Technical Communications Department, P.O. Box 1441, Minneapolis, MN 55440-1441, USA.

1. *Based on the objectives, this module:*

- Significantly exceeded my expectations
- Exceeded my expectations
- Met my expectations
- Was below my expectations
- Was significantly below my expectations

2. *Why did you select the above rating?*

3. *How do you plan to use the module information in your job?*

4. *How do you think the module could be improved?*

I verify that I have successfully completed Module No. 321-027

Title: Atomization

Signature _____

Date _____

Graco

Technical Communications Dept.

P.O. Box 1441

Minneapolis, MN 55440-1441 U.S.A.

(fold here)

(fold here)

This module was developed by the Graco Technical Communications Department with assistance from the following individuals:

Tony Brajdich
Michelle Hagman
Bob Lind
Glen Muir
Al Orr

The Graco Concept and Theory Training program consists of the following topics:

Fluid Basics
Atomization
Electrostatic Spray Finishing
Safety
Airspray Technology
Fluid Types: Paints and Other Coatings
Fluid Types: Lubricants
Fluid Types: Sealants and Adhesives
Airless Atomization
Spraying Techniques
Transfer Efficiency
Fluid Movement
Fluid Controls
Pumps
Motors and Power Sources
Plural Component Paint Handling
Plural Component Sealant and Adhesive Handling
Paint Circulating Systems
Automatic Finishing
Lube Reels and Dispense Valves
Lube Metering Systems
Electronic Fluid Management Systems