



siouxtools.com

***Tools
Designed For...
The Way You
Work***



Industrial Air Tools Product Catalog



Aviation



Natural Resources



Metal Working



Marine Industry



Wood Working



Manufactured Housing



RV Industry



Truck and Trailer Manufacturing

Sioux Tools are designed for The Way You Work!

- PERFORMANCE
- ERGONOMICS
- EASE OF MAINTENANCE
- VALUE

CATALOG INDEX

DRILLS	8
DRILLS	11 – 17
DRILL ACCESSORIES	18 – 19
ASSEMBLY	20
SCREWDRIVERS	25 – 29
NUTRUNNERS	29
RATCHET WRENCHES	30
IMPACT WRENCHES	32 – 33
IMPACT DRIVERS	34
TORQUE MULTIPLIERS	35 – 38
ASSEMBLY ACCESSORIES	38 – 39
ABRASIVE	40
GRINDERS	42 – 48
ABRASIVE ACCESSORIES	49
FINISHING	50
SANDERS	52 – 56
POLISHERS	56
FINISHING ACCESSORIES	57 – 59
PERCUSSIVE	60
SCALERS	62 – 63
HAMMERS	63
PERCUSSIVE ACCESSORIES	64 – 66
SPECIALTY	67
ROUTERS	69
CLINCH NUT TOOLS	71
TAPPERS	72
RIVET SHIVERS	72
SKIN CLAMP RUNNERS	72
SAWS & CUTOFF TOOLS	73 – 74
NIBBLERS & SHEARS	74
AEROSPACE	76 – 77
SPECIALTY ACCESSORIES	78 – 79
GENERAL ACCESSORIES	80 – 81

MODEL NUMBER INDEX | SIOUX TOOLS INDUSTRIAL CATALOG

MODEL	PAGE	MODEL	PAGE	MODEL	PAGE	MODEL	PAGE	MODEL	PAGE
270A	63	1OT2208Q	28	CH43A-H	63	RO2512-30SNP	52	SAG03S12S	45
270A-2	63	1OT2308Q	28	CH43A-R	63	RO2512-30SRH	52	SAG03S20	45
270A-4	63	1OT2508Q	28	CH44A-H	63	RO2512-30SRP	52	SAG03S20M6	45
658	54	1SM2103	25	CH44A-R	63	RO2512-30SVH	52	SAG03S20M6S	45
697	54	1SM2105Q	27	DR1412	11	RO2512-30SVP	52	SAG03S20S	45
1290	56	1SM2107	26	DR1414	11	RO2512-35FNH	52	SAG05S23	45
1291	47	1SM2205Q	27	DR1416	11	RO2512-35FNP	52	SAG05S23M6	45
1292	56	1SM2305Q	27	DR1467	16	RO2512-35FRH	52	SAG05S23M6S	45
1296	56	1SM2405	27	DR3P2240	12	RO2512-35FRP	52	SAG05S23S	45
1300	73	1SM2405Q	27	DVH-3	59	RO2512-35FVH	52	SAG10AX12	46
1410	11	1SM2407	26	DVS-5	59	RO2512-35FVP	52	SAG10AX12M6	46
1420	13	1ST2108	28	FRLK1660	36	RO2512-35SNH	52	SAG10AX15	46
1422	13	1ST2108Q	28	GO459-60SNH	53	RO2512-35SNP	52	SAG10AX15M6	46
1464	16	1ST2208Q	28	GO459-60SNP	53	RO2512-35SRH	52	SAG10AX18	46
1465	16	1ST2308Q	28	GO459-60SRH	53	RO2512-35SRP	52	SAG10AX18M6	46
1466	16	1ST2508Q	28	GO459-60SRP	53	RO2512-35SVH	52	SAG10S12	45
1980	69	2S1310	17	GO459-80SNH	53	RO2512-35SVP	52	SAG10S12M6	45
1985-1/2	42	2S1330	17	GO459-80SNP	53	RO2512-50CNH	52	SAG10S15	45
1238L	56	2S2103AQ	28	GO459-80SRH	53	RO2512-50CNP	52	SAG10S15M6	45
1285L	47	2S2103Q	28	GO459-80SRP	53	RO2512-50CRH	52	SAG10S18	45
1287L	55	2S2105Q	28	HG20AL-45S8	48	RO2512-50CRP	52	SAG10S18M6	45
1290L	56	2S2107	28	HG20AL-60S6	48	RO2512-50CVH	52	SAG7AX13	46
1291L	47	2S2110	17	HG20AL-80P3	48	RO2512-50CVP	52	SAG7AX13M6	46
1292L	56	2S2130	17	HG30AL-45S8	48	RO2512-50FNH	52	SAG7AX16	46
1410R	12	2S2201	28	HG30AL-60S6	48	RO2512-50FNP	52	SAG7AX16M6	46
1412R	12	2S2203	28	HG30AL-80P3	48	RO2512-50FRH	52	SAG7AX20	46
1465-1/2	16	2S2203AQ	28	ID375AP-2Q	34	RO2512-50FRP	52	SAG7AX20M6	46
1980A	69	2S2207	28	IW100HAI-5S	33	RO2512-50FVH	52	SAG7S12	45
1981F	69	2S2230	17	IW100HAI-5S6	33	RO2512-50FVP	52	SAG7S12M6	45
1982A	69	2S2300SR	72	IW100HAI-8H	33	RO2512-50SNH	52	SAG7S15	45
1985A	42	2S2301	28	IW100HAI-8H6	33	RO2512-50SNP	52	SAG7S15M6	45
1AM1141/51K	14	2S2303A	28	IW100HAO-5S	33	RO2512-50SRH	52	SAG7S18	45
1AM1141SRK	14	2S2303AQ	28	IW100HAO-5S6	33	RO2512-50SRP	52	SAG7S18M6	45
1AM1151SRK	14	2S2305Q	28	IW100HAO-8H	33	RO2512-50SVH	52	SAS03S122-20	55
1AM1441	14	2S2307	28	IW100HAO-8H6	33	RO2512-50SVP	52	SAS03S202-20	55
1AM1451	14	2S2310	17	IW150HAI-12H	33	RO2512-60CNH	52	SAS05S232-20	55
1AM1452	14	2S2330	17	IW150HAI-5S	33	RO2512-60CNP	52	SAS10A122-20	55
1AM1541	14	3A1140	15	IW150HAO-12H	33	RO2512-60CRH	52	SAS10A125	55
1AM1551	14	3A1240	15	IW150HAO-5S	33	RO2512-60CRP	52	SAS10A152-20	55
1AM1552	14	3A2104	29	IW375AP-3F	32	RO2512-60CVH	52	SAS10A182-20	55
1AM2101	29	3A2108	29	IW375AP-3P	32	RO2512-60CVP	52	SAS10AX125	55
1AM2102	29	3A2140	15	IW38HAP-3F	32	RO2512-60FNH	52	SAS10S125	55
1AM2105	29	3A2208	29	IW38HAP-3P	32	RO2512-60FNP	52	SC3PA	63
1AM2106	29	3A2240	15	IW38HAP-4F	32	RO2512-60FRH	52	SC3PA-C	63
1AM2201	29	3A2340	15	IW38HAP-4P	32	RO2512-60FRP	52	SC41011AL-C	62
1AM2205	29	3A2430	15	IW38HAP-7Q	34	RO2512-60FVH	52	SC41011AL-K	62
1AML1451	14	3P11401	11	IW38TBP-2Q	34	RO2512-60FVP	52	SC41011AL-N5	62
1OM2103	25	3P12401	11	IW38TBP-3P	32	RO2512-60SNH	52	SC41011AU-C	62
1OM2105Q	27	3P13401	11	IW50HAP-4F	32	RO2512-60SNP	52	SC41011AU-N5	62
1OM2107	26	3P14301	11	IW50HAP-4P	32	RO2512-60SRH	52	SC80910AL-C	62
1OM2203	25	3P15301	11	IW75BP-6H	33	RO2512-60SRP	52	SC80910AL-K	62
1OM2205Q	27	3P16401	11	IW75BP-8H	33	RO2512-60SVH	52	SC80910AL-N5	62
1OM2207	26	3P2140	12	PS690	54	RO2512-60SVP	52	SCN12R	71
1OM2303	25	3P2340	12	RO2510-44FNC	53	RS10K	73	SCN20R	71
1OM2305Q	27	3T1140	16	RO2512-30FNH	52	RT1981	69	SCN25R	71
1OM2307	26	3T1530	16	RO2512-30FNP	52	RT1982	69	SCN3R	71
1OM2403	25	3T1630	16	RO2512-30FRH	52	RT1983	69	SCN5R	71
1OM2405Q	27	3T1640	16	RO2512-30FRP	52	RT1985	42	SCN7R	71
1OM2407	26	3T2303	25	RO2512-30FVH	52	SAG03S12	45	SCO10A106	74
1OM2507	26	CH42A-H	63	RO2512-30FVP	52	SAG03S12M6	45	SCO10A125	74
1OT2108Q	28	CH42A-R	63	RO2512-30SNH	52	SAG03S12M6S	45	SCO10S184F	73

MODEL	PAGE	MODEL	PAGE	MODEL	PAGE	MODEL	PAGE	MODEL	PAGE
SCO10S184R	73	SDR10P12R3	12	SDR10S5R4	13	SSD10P20P	25	SWG10A125	47
SCO10S204F	73	SDR10P12R4	12	SDR10S60N2	13	SSD10P20PS	25	SWG10AX124	46
SCO10S204R	73	SDR10P16N3	11	SDR10S60N3	13	SSD10P20S	26	SWG10AX1245	46
SCO10S253F	73	SDR10P16N4	11	SDR10S7N3	13	SSD10P25AC	27	SWG10AX1245	47
SCO10S253R	73	SDR10P180N2	11	SDR10S7R3	13	SSD10P25P	25	SWG10AX125	46
SDG03S25	43	SDR10P20R2	12	SDR10S7R4	13	SSD10P25PS	25	SWG10S124	47
SDG03S25M6	43	SDR10P20R3	12	SDR6P12N3	12	SSD10P25S	26	SWG10S1245	47
SDG03S25M6S	43	SDR10P20R4	12	SDR6P26N2	12	SSD10P3AC	27	SWG10S183	47
SDG03S25S	43	SDR10P20RK3	12	SDR6P26N3	12	SSD10P3S	26	SWG7AX134	46
SDG05S18	43	SDR10P210N2	11	SDR6P26N4	12	SSD10P5AC	27	SWG7AX1345	46
SDG05S18M6	43	SDR10P25R2	12	SDR6P26NK3	12	SSD10P5S	26	SWG7AX203	46
SDG05S18M6S	43	SDR10P25R3	12	SDR6P40N2	12	SSD10P7AC	27	SXG05S18	44
SDG05S18S	43	SDR10P26N2	11	SDR6P40N3	12	SSD10P7S	26	SXG05S18M6	44
SDG05S23	43	SDR10P26N3	11	SDR6P40NK3	12	SSD10S12AC	27	SXG05S18M6S	44
SDG05S23M6	43	SDR10P26N4	11	SDR6P4N3	12	SSD10S12S	26	SXG05S18S	44
SDG05S23M6S	43	SDR10P26NK3	11	SDR6P4N4	12	SSD10S20AC	27	SXG05S23	44
SDG05S23S	43	SDR10P26NK4	11	SDR6P60N2	12	SSD10S20S	26	SXG05S23M6	44
SDG10P18	54	SDR10P3R3	12	SDR6P60N3	12	SSD10S25AC	27	SXG05S23M6S	44
SDG10P21	54	SDR10P3R4	12	SDR6P60NK3	12	SSD10S25S	26	SXG05S23S	44
SDG10S12F	43	SDR10P40N2	11	SDR6P7N3	12	SSD10S3AC	27	SZEA3000	77
SDG10S12M6F	43	SDR10P40N3	11	SDR6P7N4	12	SSD10S3S	26	SZEA3015	77
SDG10S12M6R	43	SDR10P40NK3	11	SNH10S18	74	SSD10S5AC	27	SZEA5000	76
SDG10S12R	43	SDR10P40R2	12	SNR10A10S	29	SSD10S5S	26	SZEA5015	76
SDG10S18F	43	SDR10P40R3	12	SNR10A16S	29	SSD10S7AC	27	SZEA5022	76
SDG10S18M6F	43	SDR10P4N3	11	SNR10A20S	29	SSD10S7S	26	SZEA5030	76
SDG10S18M6R	43	SDR10P4N4	11	SNR10A3S	29	SSD6P12AC	27	SZEA6000	77
SDG10S18R	43	SDR10P4NK4	11	SNR10A5S	29	SSD6P12P	25	SZEA6015	77
SDG10S25F	43	SDR10P5R3	12	SNR10A6S	29	SSD6P12S	26	SZEA7000	76
SDG10S25M6F	43	SDR10P5R4	12	SPS10P18	54	SSD6P20AC	27	SZEA7015	76
SDG10S25M6R	43	SDR10P60N2	11	SRS10P21-10	72	SSD6P20P	25	SZEA7022	76
SDG10S25R	43	SDR10P60N3	11	SRS10P21-5	72	SSD6P20S	26	SZEA7030	76
SDG10SHT08	42	SDR10P60NK3	11	SRS10P21-6	72	SSD6P25AC	27	SZEA8000	77
SDG10SHT08M6	42	SDR10P7N3	11	SRS10P21-7	72	SSD6P25P	25	SZEA8015	77
SDG10SHT12	42	SDR10P7N4	11	SRS10P21-8	72	SSD6P25S	26	SZEA9000	76
SDG10SHT12M6	42	SDR10P7NK4	11	SRS10P21-9	72	SSD6P7AC	27	SZEA9015	76
SDG7S18F	43	SDR10P7R3	12	SRS10S21-8	72	SSD6P7S	26	SZEA9022	76
SDG7S18M6F	43	SDR10P7R4	12	SRT10S18B	69	SSH10P18	74	SZEA9030	76
SDG7S25F	43	SDR10P7RK4	12	SRT10S18BB	69	SSH10S18	74	TM50AP-0775	35
SDG7S25M6F	43	SDR10S12N3	13	SRT10S18LT	69	SSR6P-25	72	TM50AP-0775K	35
SDR10A10N3	15	SDR10S12R3	13	SRT10S18M6B	69	ST2L1410	48	TM50AP-1075	35
SDR10A10N4	15	SDR10S12R4	13	SRT10S18M6N	69	STP10P3C20	72	TM50AP-1075K	35
SDR10A10R3	15	SDR10S16N3	13	SRT10S18N	69	STP10P3C32	72	TM50AP-15100	35
SDR10A10R4	15	SDR10S180N2	13	SRT10S25B	69	STP10S12B12	72	TM50AP-1510K	35
SDR10A13N2	15	SDR10S20R2	13	SRT10S25BB	69	STP10S3B12	72	TM50AP-25100	35
SDR10A13N3	15	SDR10S20R3	13	SRT10S25LT	69	STP10S5B12	72	TM50AP-2510K	35
SDR10A16R2	15	SDR10S20R4	13	SRT10S25M6B	69	STP10S7B12	72	TM50AP-45150	35
SDR10A16R3	15	SDR10S210N2	13	SRT10S25M6N	69	STX22-02-GW	37	TM50AP-4515K	35
SDR10A20R2	15	SDR10S25R2	13	SRT10S25N	69	STXG10S12	44	TM50AP-60150	35
SDR10A20R3	15	SDR10S25R3	13	SRW03S-25	30	STXG10S12M6	44	TM50AP-6015K	35
SDR10A22N2	15	SDR10S26N2	13	SRW03S-38	30	STXG10S12M6S	44	VG20AL-45D9	47
SDR10A22N3	15	SDR10S26N3	13	SSD10A10S	29	STXG10S12S	44	VG20AL-60C6	48
SDR10A30N2	15	SDR10S3R3	13	SSD10A16S	29	STXG10S18	44	VG20AL-60D7	47
SDR10A3R3	15	SDR10S3R4	13	SSD10A20S	29	STXG10S18M6	44	VG20AL-60D9	47
SDR10A3R4	15	SDR10S40N2	13	SSD10A3S	29	STXG10S18M6S	44	VG30AL-45D7	47
SDR10A4N3	15	SDR10S40N3	13	SSD10A5S	29	STXG10S18S	44	VG30AL-45D9	47
SDR10A4N4	15	SDR10S40N360	14	SSD10A6S	29	STXG10S23	44	VG30AL-60C6	48
SDR10A6R3	15	SDR10S40R2	13	SSD10P12AC	27	STXG10S23M6	44	VG30AL-60D7	47
SDR10A6R4	15	SDR10S40R3	13	SSD10P12P	25	STXG10S23M6S	44	VG30AL-60D9	47
SDR10P12N3	11	SDR10S4N3	13	SSD10P12PS	25	STXG10S23S	44	VS20AL-609	56
SDR10P12N4	11	SDR10S4N4	13	SSD10P12S	26	SWG10A124	47	VS20AL-727	56
SDR10P12NK3	11	SDR10S5R3	13	SSD10P20AC	27	SWG10A1245	47		

Mission

To create and serve customers with quality products and service that meet or exceed their expectations.

History

A History of Success

Sioux Tools has a long and proud heritage of innovation as they have helped to shape the face of the tool industry. The company was started in November of 1914 by Swedish tool maker, Oscar Albertson, and office boy, Harold Jacobson, with a goal to become the "best machine and tool shop". Sioux has since grown to become a trusted partner by a wide range of industrial and manufacturing segments.

Originally named Albertson & Company, the first items manufactured were piston rings, spark plugs and a gas saver. They soon expanded their line to become a powerful force in the marketplace. In early 1917, Oscar Albertson designed a valve lathe – a hand tool used to seat engine valves. This invention proved to be the foundation upon which Sioux Tools has built a reputation for innovation throughout the world.

During the 1920s the company revolutionized the tool industry by introducing some of the very first hand held power tools. In 1958 the company further solidified its position as a market leader by designing and producing its first air powered tools. Today, Sioux Tools has been granted well over 100 patents. Innovation, ingenuity and insight have established Sioux tools in the minds of the professional as the tool to depend on. Our commitment to continued development in ergonomics and innovative design ensures that we will meet the needs of professionals for many years to come.

Wherever there are markets for quality-built, reliable products, backed by strong after-sale dedication to customer satisfaction, you'll find Sioux Tools. Today we continue to strive to live up to our founding father's wish of being the "best in the world".

In 1994 Sioux Tools joined Snap-on Incorporated, which added industrial power tools to the extensive Snap-on line. Snap-on Incorporated is a leading global developer, manufacturer and marketer of tool and equipment solutions for professional tool users. Product lines include hand and power tools, diagnostics and shop equipment, tool storage products, diagnostics software and other solutions for the transportation service, industrial, government, education, agricultural, and other commercial applications, including construction and electrical. Founded in 1920, Snap-on is a \$2+ billion, S&P 500 company headquartered in Kenosha, Wisconsin and employs approximately 14,000 worldwide.

Committed

Committed to your Success

For nearly 90 years, Sioux Tools has been providing tools that have been designed and built by the best engineers in the country. We use only top-quality materials in our manufacturing process, and we offer the strongest support and warranty in the business. Our over 100 patents are an indication of our innovation in product development and design.

Sioux Tools are built tough to provide you with many years of trouble-free service. But as with any piece of equipment, service problems can occur, thus Sioux tools are designed to make servicing quick, easy and affordable.

To help ensure fast repairs, which in turn limit downtime, Sioux Tools offers training seminars that cover all the details of the tools we make. For information on our training program, please contact your local Sioux Tools representative.

ISO/Warranty

Sioux Tool Power Tools Warranty

SIoux TOOLS WARRANTS TO THE ORIGINAL PURCHASER THAT THE COMPANY'S POWER TOOLS ARE FREE FROM DEFECTS IN MATERIALS AND WORKMANSHIP. For one (1) year following the date of purchase, Sioux Tools will repair or replace, at Sioux Tools' option, any part that is defective in materials or workmanship. All warranty requests or claims must be made no later than 60 days following the end of the 1-year warranty period. Repair or replacement shall be at the election and expense of Sioux Tools, and is the exclusive remedy in place of all other rights and remedies.



NO OTHER WARRANTIES, EXPRESS, IMPLIED OR STATUTORY, INCLUDING WITHOUT LIMITATION ANY IMPLIED WARRANTY OF MERCHANTABILITY OR FITNESS FOR A PARTICULAR PURPOSE, SHALL APPLY AND ALL SUCH WARRANTIES ARE HEREBY EXPRESSLY DISCLAIMED. Sioux Tools' warranty applies only to new products purchased from Sioux Tools or its authorized distributors. Sioux Tools does NOT provide warranty for products subjected to abnormal use. Abnormal use includes: misuse, accident, modification, unreasonable use, neglect, lack of maintenance, or use after the tool is significantly worn or repaired by someone other than Sioux Tools or its Authorized Service Representatives.

A consumable product or part is warranted at the time of sale, only against defects in workmanship and materials that prevent its use. Consumable items are goods reasonably expected to be used up or damaged during use, including but not limited to drill bits, saw blades, grinding discs, sanding discs, batteries, and light bulbs.

SIoux TOOLS SHALL NOT BE LIABLE FOR ANY INCIDENTAL, SPECIAL, CONSEQUENTIAL COSTS OR DAMAGES INCURRED BY THE PURCHASER OR OTHERS (including, without limitation, lost profits, revenues, anticipated sales, business opportunities or goodwill, interruption of business and any other injury or damage.)

This warranty is non-transferable. Sioux Tools reserves the right to make changes in design and/or construction at any time without incurring any obligation related to tools previously sold.

ISO 9001

In 1997 Sioux Tools received its ISO 9001 certification. This certification is essential to doing business in today's global marketplace. It affirms our dedication to quality and our continued commitment to improvement. It assures our customers that the products they purchase will consistently live up to the promise of performance. It also validates our target goal of achieving maximum quality in every stage of the process - from the initial concept and development all the way through the delivery of spare parts. Our customers can be certain that Sioux tools will live up to their high expectations and provide a long, trouble-free life.



Industrial Tools

Sioux Tools is known around the world for quality, durability and performance. Our extensive and always expanding line of industrial power tools are engineered to make any job easier, safer and more efficient. We build tools that stand up to the demanding specifications required by today's industrial manufacturing, assembly and finishing needs. Our industrial line of tools is second to none in power, workmanship and total quality.

We Design Tools To Fit The Application

Sioux has been an innovator in designing tools that fill unique applications. The exclusive Z-handle design enables manufacturers to have a tool that will fit into extremely tight spaces yet maintain the full industrial power.

Research & Development

As new manufacturing techniques develop they bring with them new demands that may not be met with conventional air tools. Sioux Tools is ready to meet these needs by utilizing our engineering technology coupled with the latest innovations and technological advancements in the power tool industry.

We research the need to develop a new tool and then our Sioux team of engineers and designers go to work to produce the most efficient and versatile tool possible. We are constantly working to increase our product offering, but those new products must live up to our high expectations. Our extensive design engineering, research and development experience has proven our ability and commitment to build quality tools.

Continuous Quality Control

Every Sioux product undergoes rigorous performance tests at precise stages from design conception through product assembly and packaging to ensure they meet our own high standards and the demands of our customers. Only the finest materials are used in production, and no tool leaves our plant without thorough testing to meet Sioux quality standards. We've built our reputation on producing top-of-the-line industrial tools.

The Signature Series

Inspired by the operator, designed by Sioux Tools. Since 1914, Sioux Tools has been committed to bringing productive solutions to the pneumatic power tool industry.

Signature Series is an innovative pneumatic power tool program created through the implementation of next generation ergonomics, productivity enhanced features, value and accuracy.

Through industry research and operator input, we have engineered a program that truly delivers tools for the way you work!



Catalog Guide

Photos

Visual reference of selective models

Color-coded Tabs

Quick reference indicator to locate a particular section

Product Description

Instant reference to the type of tools displayed

Performance

Range of principle performance characteristics

Features

List of significant features common to all items

Specification Chart

Comparison chart of all models in this category including performance specifications and characteristics

General Info

Specifications that are common to all tools on the page

Standard Equipment

Listing of items that are included with purchase

Accessories

Shows what accessories are available or where to locate them in the catalog

DRILLS | SIOUX TOOLS INDUSTRIAL CATALOG

PISTOL GRIP DRILLS

1410, SDR10P26N3, 3P1640, SDR10P26NK3

Performance:
 Power: 0.33 hp (0.25 kw) - 1 hp (0.73 kw)
 Speed Range: 300 rpm - 6000 rpm
 Chuck Capacity: 1/4" (6 mm) - 1/2" (13 mm)

Features:
 Reversible and Non-Reversible
 Trigger Start
 Retractable Exhaust (0.33 hp models)
 Rubber Grip

Pistol Grip Drills

Model Number	Chuck Capacity		Free Speed	Weight	Length		Spindle Thread	Maximum Air Consumption	Sound Level	Spindle Thread		
	In.	mm			In.	mm						
0.33 hp (0.25 kw) - Non-reversible												
1410	1/4	6	2950	1.3	0.6	6.3	1/8	13	12	80	3/8"-24	
DR1412	1/4	6	3800	1.3	0.6	8.3	1/8	13	12	80	3/8"-24	
DR1414	1/4	6	4500	1.3	0.6	8.3	1/8	13	12	80	3/8"-24	
DR1415	1/4	6	6000	1.3	0.6	8.3	1/8	13	12	80	3/8"-24	
1 hp (0.73 kw) - Non-reversible												
SDR10P26N3	1/4	6	6000	3.30	1.05	6.8	1/8	20	30	14.2	80	3/8"-24
SDR10P26N3	3/8	10	6000	3.45	1.10	7.0	1/8	20	30	14.2	80	3/8"-24
SDR10P26N3	1/4	6	4000	3.30	1.05	8.5	1/8	20	30	14.2	80	3/8"-24
SDR10P26N3	3/8	10	4000	3.45	1.10	7.0	1/8	20	30	14.2	80	3/8"-24
SDR10P26N3	1/4	6	2000	2.90	1.05	6.5	1/8	20	30	14.2	80	3/8"-24
SDR10P26N3	3/8	10	2000	3.48	1.10	7.0	1/8	20	30	14.2	80	3/8"-24
SDR10P26N4	1/2	13	2500	2.90	1.00	7.5	1/8	20	30	14.2	80	1/2"-20
SDR10P26N4	3/8	10	1200	2.90	1.30	8.0	3/8	20	30	14.2	80	3/8"-24
SDR10P26N4	3/8	10	700	2.90	1.30	8.0	3/8	20	30	14.2	80	1/2"-20
SDR10P26N4	1/2	13	700	3.20	1.30	8.0	3/8	20	30	14.2	80	1/2"-20
SDR10P26N4	3/8	10	400	2.90	1.30	8.0	3/8	20	30	14.2	80	1/2"-20
SDR10P26N4	1/2	13	400	3.30	1.50	8.0	3/8	20	30	14.2	80	1/2"-20
1 hp (0.73 kw) - Non-reversible With Keyless Chuck												
SDR10P26N3	3/8	10	6000	2.45	1.10	7.0	1/8	20	30	14.2	80	3/8"-24
SDR10P26N3	3/8	10	4000	2.50	1.05	8.3	1/8	18	30	14.2	79	3/8"-24
SDR10P26N3	3/8	10	2000	2.25	1.05	6.3	1/8	20	30	11.8	80	3/8"-24
SDR10P26N4	1/2	13	2000	2.75	1.25	6.8	1/8	20	30	11.8	80	1/2"-20
SDR10P26N4	3/8	10	1500	2.70	1.20	7.3	1/8	20	30	11.8	80	3/8"-24
SDR10P26N4	1/2	13	700	3.15	1.40	7.8	3/8	20	30	13.8	80	1/2"-20
SDR10P26N4	1/2	13	400	3.10	1.40	7.8	3/8	20	30	13.8	80	1/2"-20

Notes:
 An Inlet Size: 1/4" NPT • Recommended Hose Size: 1/4" ID (3/8" OD) • Performance values @ 90 psi (6.3 bar) air pressure

Standard Equipment:
 Parts List • Safety and Instruction Manual • 3-pc Chuck and Key • Custom Grip

Accessories: see pages 25-28

SAFETY PRECAUTION: Read and follow all safety and operating instructions.
WARNING: Face & eye protection must be worn while operating power tools, per ANSI B186.1

Safety Info

A brief reminder of safety when operating industrial power tools

Catalog Guide

Standard Equipment

Under this heading a specification is given for each type of tool and of the parts (nipples, keys, guards, etc.) supplied with the tool.

A parts list and safety and instruction manual are always included in the package with every tool.

Air Consumption

The air consumption of the tools is stated in cubic feet per minute (cfm) and liters per second, l/s, and relates to free air, i.e., the compressed air expanded to atmospheric pressure. Unless otherwise stated, the figures are valid at a working pressure of 90 psig (6.2 bar) and indicate the maximum air consumption unless otherwise stated.

Maximum air consumption for non-governed tools is achieved at free speed when the tool is running at no load. A tool with governed speed control has the maximum air consumption at the maximum power output.

Speed

The tool speeds are indicated in revolutions per minute, (rpm), and indicate the free speed, i.e., the speed at which the tool runs at no load and at a working pressure of 90 psig (6.2 bar), unless otherwise specified. The speed at maximum output is estimated as 50% of the idling speed for non-governed tools and 80-90% of the idling speed for tools with governed speed control.

Quick Conversion Chart

Length:

1 in	=	0.0254 m
1 m	=	39.3701 in
1 m	=	3.2808 ft
1 in	=	25.4 mm
1 ft	=	304.8 mm
1 mm	=	0.03937 in

Weight:

1 lb	=	0.4536 kg
1 kg	=	2.2046 lb

Torque:

1 kpm	=	9.8067 Nm
1 ft lb	=	1.3558 Nm
1 in lb	=	0.1130 Nm
1 Nm	=	0.1020 kpm
1 Nm	=	0.7376 ft lb

Model Number

Many tools have very similar performance characteristics. These subtle differences are often indicated by the addition of letters after the model number.

Weight and Length

The weight of the tools is listed in both pounds (lb) and kilograms (kg), and the length is listed in both inches (in) and millimeters (mm).

Side to Center

This measurement is taken from the center of the tool to the outside edge. It is useful for applications requiring the tool to fit into a precise or limited space.

Sound Level

In the field of ergonomics, sound level is very important to the safety and well-being of the operator. Sound levels are listed, where applicable, in decibels dB(A).

Pressure:

1 bar	=	100 kPa
1 kg/cm ² (at)	=	98.0665 kPa
1 psi	=	6.8948 kPa
1 kPa	=	0.145 psi
1 kPa	=	0.01 bar
1 kPa	=	0.0101972 kg/cm ² (at)

Power:

1 kgm/s	=	9.8067 w
1 hp	=	745.7 w
1 kw	=	101.972 kgm/s
1 kw	=	1.3410 hp

Flow:

1 m ³ /min	=	16.6667 l/s
1 cfm	=	0.4720 l/s
1 m ³ /h	=	0.2778 l/s
1 l/s	=	2.1189 cfm



DRILLS



Index	
Drills	11 – 17
Drill Accessories	18 – 19

DRILLS

Performance, Serviceability, Ergonomics and Value...



Light weight aluminum housing



Ergonomic, handle with soft textured grip



Available in 1 HP and .6 HP motor



3 planet gear system for increased life and load capacity



Teasing throttle, conveniently located reverse

Industry Leader

Regarded as the Number 1 choice in the industry, Sioux Tools' pneumatic drills are known around the world for their exceptional engineering and construction. A wide range of configurations, speeds, and options ensure a perfect match for any application. Through next generation ergonomics and the continued focus on productivity and operator safety comes the development of the Sioux Tools Signature Series Drill line.

Signature Series Drills are used in applications ranging from manufactured housing and wood working to light assembly. With free speeds from 300 to 16,000 rpm we have the right drill for any application, for use with any type of material. The powerful five vane motor makes these drills great for drilling applications that contain ferrous and non-ferrous metals, wood and composite materials. The Signature Series Drills offer great value with a 3 planet gear system for increased life and load capacity. The Sioux tools Signature Series Drill line reduces operator fatigue by offering a low sound level and low vibration solution! Operator comfort is achieved through the implementation of a light weight aluminum housing and a comfort grip. Drills are available in both reverse and non-reverse models and are available in pistol grip, straight, Z-handle and D and T-handles, and offer a variety of chuck and collet size.

Innovative Design

Our exclusive Z-handle models are often the only drills that will get you into those tough, hard to reach spaces, and our miniature aircraft angle drills are designed with small, compact 45° and 90° heads and internal threaded spindles that accept a variety of aircraft precision drill bits.

360° Rotation

The SDR10S40N360 has a unique 360° rotating head for applications in hard to reach places or difficult angles.

T-Handles

Our exceptional T-handle drills help reduce stress on the operators back and arms while making short work of any decking application.

Ergonomics

All Sioux Drills offer ergonomic features to provide maximum comfort during operation. Many models include comfortable insulating grips to reduce cold and vibration. We also offer optional support handles for most models.

Drill Maintenance

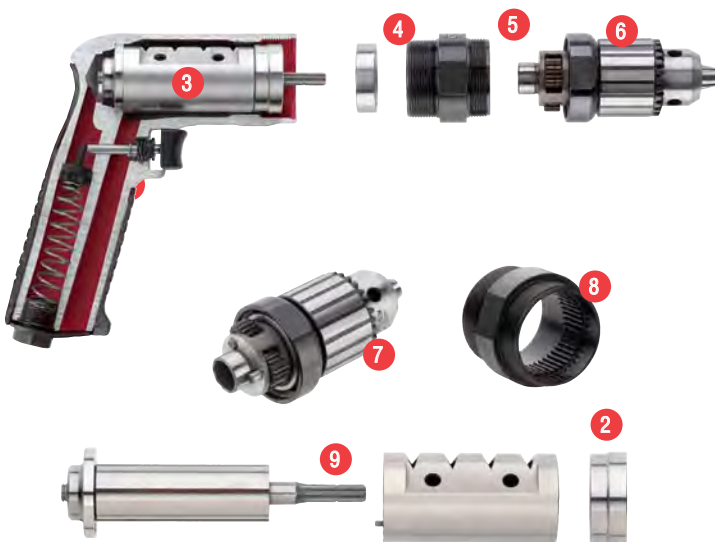

- 1 Tipper valve and valve seat is easily accessible for service
- 2 Slip fit of front end plate bearing allows easy service of the air motor without disturbing the rotor spacing
- 3 Drop in motor. No alignment necessary (applies to non-reversing drills only)
- 4 Rotor pinion is case hardened to resist wear
- 5 Grease zerk makes it easy to grease the gears without disassembly
- 6 Planetary reduction can be serviced without removing the chuck
- 7 Planet gear pins are slip fit for ease of assembly and disassembly
- 8 Ring gear is machined into the motor retainer for ease of assembly and disassembly
- 9 Interchangeable rotor, cylinder, bearings and end plates. This reduces the number of spare parts tool cribs need to stock

Accessories

Sioux carries an extensive selection of drill accessories, including hole saws and wire brushes.

See the drill accessory section in this catalog for a comprehensive listing.

Drill Safety

Chips can cause eye injury.

Drilling creates chips. Proper eye protection must be worn at all times by tool user and bystanders.

Broken drill bits can cause eye injury.

Proper eye protection must be worn at all times by tool user and bystanders.

Sudden and unexpected tool movement can cause injury.

Be sure your body position allows you to have control of the tool at all times. Make sure your footing is secure.

Tools starting unexpectedly can cause injury.

Always remove tool from air supply and activate trigger to bleed air line before making any adjustments, changing accessories, or doing any maintenance or service on the tool.

Drill Principles of Operation

An air motor and reduction gearing are used to drive a spindle / drill chuck, which holds accessories for drilling, reaming, tapping, and hole sawing. Motor size (horsepower), gear ratio, handle style and drive spindle determine the type of tool needed to handle an application.

Drill Uses

Pneumatic drills may first be thought of for drilling holes in wood, metal, or plastic. Drills are used in a wide variety of applications. Each of these applications require the proper tool with the proper horsepower and speed to get the best results. Drilling – cutting a hole in material using a fluted bit. Reaming – opening up or sizing a previously drilled hole or aligning offset holes. Tapping – cutting threads in a drilled hole to accept threaded fasteners.

Where Used

- Continuous-duty production drilling
- For initial tap operations and thread chasing
- Wire brushing and deburring
- Screwdriving
- Hole sawing
- General Maintenance

Considerations for Selecting Drills

- What type of material is being drilled?
- What size of hole will need to be drilled?
- What are your horsepower requirements?
- What speed requirements do you have?

Drill Speed Guide

Drill Speed Guide

Material	Surface Ft/Min	Size of Hole to be Drilled							
		1/16 in 1.5 mm	1/8 in 3.0 mm	3/16 in 5.0	1/4 in 6.0 mm	5/16 in 8.0 mm	3/8 in 9.5 mm	7/16 in 11.0 mm	1/2 in 13.0 mm
Recommended Cutting Speed Range (rpm)									
Steel Alloy, 300-400 Brinell	20-30	1250-1800	600-900	400-600	300-450	250-350	200-300	175-250	150-225
Stainless Steel, Cast Iron, Hard	30-40	1800-2500	900-1200	600-800	450-600	350-500	300-400	250-350	225-300
Steel Forgings	40-50	2500-3100	1200-1500	800-1000	600-750	500-600	400-500	350-425	300-400
Steel, Tool Annealed, .90-1.20 Carbon	50-60	3100-3700	1500-1800	100-1200	750-900	600-700	500-600	425-525	400-450
Steel, .40-.50 Carbon	70-80	4300-5000	2100-2500	1400-1600	1000-1200	850-1000	700-800	600-700	500-600
Cast Iron, Medium Hard	70-100	4300-6000	2100-3000	1400-2000	1000-1500	850-1200	700-1000	600-900	500-800
Bronze, High Tensile Strength	70-150	4300-9000	2100-4500	1400-3000	1000-2300	850-1200	700-1530	600-1300	500-1200
Malleable Iron	80-90	5000-5500	2500-2800	1600-1800	1200-1400	950-1100	800-900	700-800	600-700
Steel, Mild .20-.30 Carbon	80-110	5000-6700	2500-3400	1600-2300	1200-1700	950-1350	800-1150	700-1000	600-850
Cast Iron, Soft Plastic	100-150	6000-9000	3000-4500	2000-3000	1500-2300	1200-1800	1000-1530	900-1300	800-1200
Aluminum, Brass, Bronze	200-300	12,000-18,000	6000-9000	4000-6000	3000-4500	2400-3700	2000-3000	1700-2600	1500-2300
Magnesium	250-400	15,500-25,000	7500-12,000	5000-8200	3800-6100	3000-4900	2500-4000	2200-3500	1900-3000
Fiberglass, Wood	300-400	18,000-25,000	9000-12,000	6000-8200	4600-6100	3700-4900	3000-4000	2600-3500	2300-3000

Actual drilling or cutting RPM will be approximately 80% of rated spindle speed of tool. Surface Feet Per Minute = .26 x RPM x Drill Diameter in Inches.

PISTOL GRIP DRILLS



Performance:

Power: 0.33 hp (0.25 kw) – 1 hp (0.75 kw)
 Speed Range: 360 rpm – 21,000 rpm
 Chuck Capacity: 1/4" (6 mm) – 1/2" (13 mm)

Features:

Reversible and Non-Reversible
 Trigger Start
 Rotatable Exhaust (0.33 hp models)
 Rubber Grip

Pistol Grip Drills



Model Number	Chuck Capacity		Free Speed rpm	Weight		Length		Side To Center		Maximum Air Consumption		Sound Level dB(A)	Spindle Thread
	in	mm		lb	kg	in	mm	in	mm	cfm	l/s		
.33 hp (0.25 kw) – Non-reversible													
1410	1/4	6	2600	1.3	0.60	6.3	160	0.6	15	12	6	75	3/8"-24
DR1412	1/4	6	3600	1.3	0.60	6.3	160	0.6	15	12	6	75	3/8"-24
DR1414	1/4	6	4300	1.3	0.60	6.3	160	0.6	15	12	6	75	3/8"-24
DR1416	1/4	6	6000	1.3	0.60	6.3	160	0.6	15	12	6	75	3/8"-24
1 hp (0.75 kw) – Non-reversible													
SDR10P4N3	3/8	10	400	2.9	1.30	8.0	205	0.8	20	30	14	80	1/2"-20
SDR10P4N4	1/2	13	400	3.3	1.50	8.5	215	0.8	20	30	14	80	1/2"-20
SDR10P7N3	3/8	10	700	2.9	1.30	8.0	205	0.8	20	30	14	80	1/2"-20
SDR10P7N4	1/2	13	700	3.3	1.50	8.5	215	0.8	20	30	14	80	1/2"-20
SDR10P12N3	3/8	10	1200	2.9	1.30	8.0	205	0.8	20	30	14	80	1/2"-20
SDR10P12N4	1/2	13	1200	3.3	1.50	8.5	215	0.8	20	30	1/4	80	1/2"-20
SDR10P16N3	3/8	10	1600	2.9	1.30	8.0	205	0.8	20	30	14	80	1/2"-20
SDR10P16N4	1/2	13	1600	3.3	1.50	8.5	215	0.8	20	30	1/4	80	1/2"-20
SDR10P26N2	1/4	6	2600	2.3	1.05	6.5	165	0.8	20	30	14	80	3/8"-24
SDR10P26N3	3/8	10	2600	2.5	1.10	7.0	180	0.8	20	30	14	80	3/8"-24
SDR10P26N4	1/2	13	2600	2.9	1.30	7.5	190	0.8	20	30	14	80	1/2"-20
SDR10P40N2	1/4	6	4000	2.3	1.05	6.5	165	0.8	20	30	14	80	3/8"-24
SDR10P40N3	3/8	10	4000	2.5	1.10	7.0	180	0.8	20	30	14	80	3/8"-24
SDR10P60N2	1/4	6	6000	2.3	1.05	6.5	165	0.8	20	30	14	80	3/8"-24
SDR10P60N3	3/8	10	6000	2.5	1.10	7.0	180	0.8	20	30	14	80	3/8"-24
SDR10P180N2	1/4	6	18,000	1.85	0.84	5.5	140	0.8	20	30	14	80	3/8"-24
SDR10P210N2	1/4	6	21,000	1.85	0.84	5.5	140	0.8	20	30	14	80	3/8"-24
1 hp (0.75 kw) – Non-reversible													
3P1140 ¹	1/2	13	360	5.0	2.30	8.8	224	1-1/32	26	33	15	80	1/2"-20
3P1240 ¹	1/2	13	650	5.0	2.30	8.8	224	1-1/32	26	33	15	80	1/2"-20
3P1340 ¹	1/2	13	1000	5.0	2.30	8.8	224	1-1/32	26	33	15	80	1/2"-20
3P1430 ¹	3/8	10	1400	5.0	2.30	8.8	224	1-1/32	26	33	15	80	1/2"-20
3P1530 ¹	3/8	10	2150	4.3	2.00	7.5	190	1-1/32	26	33	15	80	1/2"-20
3P1640 ¹	1/2	13	2650	4.3	2.00	7.5	190	1-1/32	26	33	15	80	1/2"-20
1 hp (0.75 kw) – Non-reversible With Keyless Chuck													
SDR10P4NK4	1/2	13	400	3.1	1.40	7.8	200	0.8	20	25	12	80	1/2"-20
SDR10P7NK4	1/2	13	700	3.1	1.40	7.8	200	0.8	20	25	12	80	1/2"-20
SDR10P12NK3	3/8	10	1200	2.7	1.20	7.3	185	0.8	20	25	12	80	3/8"-24
SDR10P26NK3	3/8	10	2600	2.3	1.00	6.3	160	0.8	20	25	12	80	3/8"-24
SDR10P26NK4	1/2	13	2600	2.7	1.20	6.6	170	0.8	20	25	12	80	1/2"-20
SDR10P40NK3	3/8	10	4000	2.3	1.05	8.3	210	0.8	19	30	14	78	3/8"-24
SDR10P60NK3	3/8	10	6000	2.5	1.10	7.0	180	0.8	20	30	14	80	3/8"-24

¹ Not CE compliant

General:

Air Inlet Size: 1/4" NPT • Recommended Hose Size: 3/8" (10 mm) • Performance rated @ 90 psig (6.2 bar) air pressure

Standard Equipment:

Parts List • Safety and Instruction Manual • 3-jaw Chuck and Key • Comfort Grip

Accessories:

Drill Accessories, see pages 18 – 19



SAFETY PRECAUTION: Read and follow all safety and operating instructions.
WARNING: Face & eye protection must be worn while operating power tools, per ANSI B186.1

PISTOL GRIP DRILLS



Performance:

Power: 0.20 hp (0.15 kw) – 1 hp (0.75 kw)
 Speed Range: 300 rpm – 6000 rpm
 Chuck Capacity: 1/4" (6 mm) – 1/2" (13 mm)

Features:

Reversible and Non-Reversible
 Trigger Start
 Rotatable Exhaust (1410 series models)
 Rubber Grip

Pistol Grip Drills

Model Number	Chuck Capacity		Free Speed	Weight		Length		Side To Center		Maximum Air Consumption		Sound Level	Spindle Thread
	in	mm	rpm	lb	kg	in	mm	in	mm	cfm	l/s	dB(A)	
.60 hp (0.45 kw) – Non-Reversible													
SDR6P4N3	3/8	10	400	2.7	1.20	7.3	185	0.8	20	25	12	80	1/2"-20
SDR6P4N4	1/2	13	400	3.1	1.40	7.8	200	0.8	20	25	12	80	1/2"-20
SDR6P7N3	3/8	10	700	2.7	1.20	7.3	185	0.8	20	25	12	80	1/2"-20
SDR6P7N4	1/2	13	700	3.1	1.40	7.8	200	0.8	20	25	12	80	1/2"-20
SDR6P12N3	3/8	10	1200	2.7	1.20	7.3	185	0.8	20	25	12	80	1/2"-20
SDR6P26N2	1/4	6	2600	2.1	0.95	5.8	145	0.8	20	25	12	80	3/8"-24
SDR6P26N3	3/8	10	2600	2.3	1.00	6.3	160	0.8	20	25	12	80	3/8"-24
SDR6P26N4	1/2	13	2600	2.7	1.20	6.6	170	0.8	20	25	12	80	1/2"-20
SDR6P40N2	1/4	6	4000	2.1	0.95	5.8	145	0.8	20	25	12	80	3/8"-24
SDR6P40N3	3/8	10	4000	2.3	1.00	6.3	160	0.8	20	25	12	80	3/8"-24
SDR6P60N2	1/4	6	6000	2.1	0.95	5.8	145	0.8	20	25	12	80	3/8"-24
SDR6P60N3	3/8	10	6000	2.3	1.00	6.3	160	0.8	20	25	12	80	3/8"-24
.60 hp (0.45 kw) – Non-Reversible With Keyless Chuck													
SDR6P26NK3	3/8	10	2600	2.3	1.00	6.3	160	0.8	20	25	12	80	3/8"-24
SDR6P40NK3	3/8	10	4000	2.3	1.00	6.3	160	0.8	20	25	12	80	3/8"-24
SDR6P60NK3	3/8	10	6000	2.3	1.00	6.3	160	0.8	20	25	12	80	3/8"-24
.20 hp (0.15 kw) – Reversible													
1410R	1/4	6	2000	1.3	0.60	6.3	160	0.6	15	10	5	75	3/8"-24
1412R	1/4	6	2600	1.3	0.60	6.3	160	0.6	15	10	5	75	3/8"-24
0.80 hp (0.60 kw) – Reversible													
3P2140	1/2	13	300	5.0	2.30	8.8	224	1-1/32	26	33	15	81	1/2"-20
DR3P2240	1/2	13	550	5.0	2.30	8.8	224	1-1/32	26	33	15	81	1/2"-20
3P2340	1/2	13	850	5.0	2.30	8.8	224	1-1/32	26	33	15	81	1/2"-20
1 hp (0.75 kw) – Reversible With Keyless Chuck													
SDR10P7RK4	1/2	13	700	3.5	1.60	9.5	241	0.8	20	30	14	80	1/2"-20
SDR10P20RK3	3/8	10	2000	2.7	1.20	8	203	0.8	20	30	14	80	3/8"-24
1 hp (0.75 kw) – Reversible													
SDR10P3R3	3/8	10	300	3.1	1.40	8.6	220	0.8	20	30	14	80	1/2"-20
SDR10P3R4	1/2	13	300	3.6	1.60	9.1	230	0.8	20	30	14	80	1/2"-20
SDR10P5R3	3/8	10	500	3.1	1.40	8.6	220	0.8	20	30	14	80	1/2"-20
SDR10P5R4	1/2	13	500	3.6	1.60	9.1	230	0.8	20	30	14	80	1/2"-20
SDR10P7R3	3/8	10	700	3.1	1.40	8.6	220	0.8	20	30	14	80	1/2"-20
SDR10P7R4	1/2	13	700	3.6	1.60	9.1	230	0.8	20	30	14	80	1/2"-20
SDR10P12R3	3/8	10	1200	3.1	1.40	8.6	220	0.8	20	30	14	80	1/2"-20
SDR10P12R4	1/2	13	1200	3.6	1.60	9.1	230	0.8	20	30	14	80	1/2"-20
SDR10P20R2	1/4	6	2000	2.4	1.10	7.1	180	0.8	20	30	14	80	3/8"-24
SDR10P20R3	3/8	10	2000	2.6	1.15	7.6	195	0.8	20	30	14	80	3/8"-24
SDR10P20R4	1/2	13	2000	3.0	1.35	7.9	200	0.8	20	30	14	80	1/2"-20
SDR10P25R2	1/4	6	2500	2.4	1.10	7.1	180	0.8	20	30	14	80	3/8"-24
SDR10P25R3	3/8	10	2500	2.6	1.15	7.6	195	0.8	20	30	14	80	3/8"-24
SDR10P40R2	1/4	6	4000	2.4	1.10	7.1	180	0.8	20	30	14	80	3/8"-24
SDR10P40R3	3/8	10	4000	2.6	1.15	7.6	195	0.8	20	30	14	80	3/8"-24

General:

Air Inlet Size: 1/4" NPT • Recommended Hose Size: 3/8" (10 mm) • Performance rated @ 90 psig (6.2 bar) air pressure

Standard Equipment:

Accessories:

Parts List • Safety and Instruction Manual • 3-jaw Chuck and Key • Comfort Grip
 Drill Accessories, see pages 18 – 19



SAFETY PRECAUTION: Read and follow all safety and operating instructions.
WARNING: Face & eye protection must be worn while operating power tools, per ANSI B186.1

STRAIGHT DRILLS



1420



SDR10S26N3



SDR10S25R3

Performance:

Power: 0.33 hp (0.25 kw) – 1 hp (0.75 kw)
 Speed Range: 300 rpm – 21,000 rpm
 Chuck Capacity: 1/4" (6 mm) – 1/2" (13 mm)

Features:

Reversible and Non-Reversible
 Lever Start
 Rubber Grip (1420, 1422)

Straight Drills



Model Number	Chuck Capacity		Free Speed	Weight		Length		Side To Center		Maximum Air Consumption		Sound Level	Spindle Thread
	in	mm	rpm	lb	kg	in	mm	in	mm	cfm	l/s	dB(A)	
.33 hp (0.25 kw) – Non-reversible													
1420	1/4	6	2600	1.2	0.54	8.0	203	.6	15	12	6	75	3/8"-24
1422	1/4	6	3600	1.2	0.54	8.0	203	.6	15	12	6	75	3/8"-24
1 hp (0.75 kw) – Non-reversible													
SDR10S4N3	3/8	10	400	2.8	1.25	9.3	236	0.8	20	30	14	78	1/2"-20
SDR10S4N4	1/2	13	400	2.8	1.25	9.3	236	0.8	20	30	14	78	1/2"-20
SDR10S7N3	3/8	10	700	2.8	1.25	9.3	236	0.8	20	30	14	78	1/2"-20
SDR10S12N3	3/8	10	1200	2.8	1.25	9.3	236	0.8	20	30	14	78	1/2"-20
SDR10S16N3	3/8	10	1600	2.8	1.25	9.3	236	0.8	20	30	14	78	1/2"-20
SDR10S26N2	1/4	6	2600	2.3	1.05	8.3	211	0.8	20	30	14	78	3/8"-24
SDR10S26N3	3/8	10	2600	2.3	1.05	8.3	211	0.8	20	30	14	78	3/8"-24
SDR10S40N2	1/4	6	4000	2.3	1.05	8.3	211	0.8	20	30	14	78	3/8"-24
SDR10S40N3	3/8	10	4000	2.3	1.05	8.3	211	0.8	20	30	14	78	3/8"-24
SDR10S60N2	1/4	6	6000	2.3	1.05	8.3	211	0.8	20	30	14	78	3/8"-24
SDR10S60N3	3/8	10	6000	2.3	1.05	8.3	211	0.8	20	30	14	78	3/8"-24
SDR10S180N2	1/4	6	18,000	1.85	0.84	7.3	185	0.8	20	30	14	78	3/8"-24
SDR10S210N2	1/4	6	21,000	1.85	0.84	7.3	185	0.8	20	30	14	78	3/8"-24
1 hp (0.75 kw) – Reversible													
SDR10S3R3	3/8	10	300	2.8	1.25	10.8	273	0.8	20	30	14	78	1/2"-20
SDR10S3R4	1/2	13	300	3.2	1.45	11.3	285	0.8	20	30	14	78	1/2"-20
SDR10S5R3	3/8	10	500	2.8	1.25	10.8	273	0.8	20	30	14	78	1/2"-20
SDR10S5R4	1/2	13	500	3.2	1.45	11.3	285	0.8	20	30	14	78	1/2"-20
SDR10S7R3	3/8	10	700	2.8	1.25	10.8	273	0.8	20	30	14	78	1/2"-20
SDR10S7R4	1/2	13	700	3.2	1.45	11.3	285	0.8	20	30	14	78	1/2"-20
SDR10S12R3	3/8	10	1200	2.8	1.25	10.8	273	0.8	20	30	14	78	1/2"-20
SDR10S12R4	1/2	13	1200	3.2	1.45	11.3	285	0.8	20	30	14	78	1/2"-20
SDR10S20R2	1/4	6	2000	2.2	1.00	9.3	235	0.8	20	30	14	78	3/8"-24
SDR10S20R3	3/8	10	2000	2.3	1.05	9.8	248	0.8	20	30	14	78	3/8"-24
SDR10S20R4	1/2	10	2000	2.8	1.25	10.3	260	0.8	20	30	14	78	1/2"-20
SDR10S25R2	1/4	6	2500	2.2	1.00	9.3	235	0.8	20	30	14	78	3/8"-24
SDR10S25R3	3/8	10	2500	2.3	1.05	9.8	248	0.8	20	30	14	78	3/8"-24
SDR10S40R2	1/4	6	4000	2.2	1.00	9.3	235	0.8	20	30	14	78	3/8"-24
SDR10S40R3	3/8	10	4000	2.3	1.05	9.8	243	0.8	20	30	14	78	3/8"-24

General:

Air Inlet Size: 1/4" NPT • Recommended Hose Size: 3/8" • Performance rated @ 90 psig (6.2 bar) air pressure

Standard Equipment:

Parts List • Safety and Instruction Manual • Suspension Bail • 3-jaw Chuck and Key • Comfort Grip

Accessories:

Drill Accessories, see pages 18 – 19



SAFETY PRECAUTION: Read and follow all safety and operating instructions.
WARNING: Face & eye protection must be worn while operating power tools, per ANSI B186.1

MINIATURE ANGLE DRILLS



1AM1551



SDR10S40N360



1AML1451



1AM1541



1AM1141SRK

Performance:

Power: 0.33 hp (0.25 kw) – 0.75 hp (0.56 kw)
 Speed Range: 540 rpm – 4000 rpm

Features:

Non-Reversible
 Lever Start
 45° or 90° Miniature Angle Heads (except SDR10S40N360)
 180° Adjustable Rotating Head (SDR10S40N360)



Miniature Angle Drills

Model Number	Free Speed	Weight		Length		Side To Center		Maximum Air Consumption		Sound Level
	rpm	lb	kg	in	mm	in	mm	cfm	l/s	dB(A)
45° Angle Head – .33 hp (0.25 kw) – 1/4"-28 Internal Thread Spindle										
1AM1441	2200	1.5	0.7	10.2	259	0.3	8	12	6	75
1AM1541	2800	1.5	0.7	10.2	259	0.3	8	12	6	75
90° Angle Head – .33 hp (0.25 kw) – 1/4"-28 Internal Thread Spindle										
1AM1451	2200	1.5	0.7	9.7	246	0.3	8	12	6	75
1AML1451 (with Lever Lock)	2200	1.5	0.7	9.7	246	0.3	8	12	6	75
1AM1551	2800	1.5	0.7	9.7	246	0.3	8	12	6	75
90° Angle Head – .33 hp (0.25 kw) – 9/32"-40 Internal Thread Spindle										
1AM1452	2200	1.5	0.7	9.7	246	0.3	8	12	6	75
1AM1552	2800	1.5	0.7	9.7	246	0.3	8	12	6	75
180° Rotating Head – .75 hp (0.56 kw) – Chuck Capacity: #70 thru 1/4"										
SDR10S40N360	4000	2.7	1.3	12.5	318	0.8	20	30	14	80
Sealant Removal Tool Kit										
1AM1141/51K	800	1.8	.80	11.5	292	0.3	8	12	6	75
Includes 1AM1151 (90° Angle Drill) and 65213 (45° Angle Drill Head Assembly)										
1AM1141SRK	800	1.8	.80	11.5	292	0.3	8	12	6	75
Includes 1AM1141 (45° Angle Drill)										
1AM1151SRK	800	1.8	.80	11.5	292	0.3	8	12	6	75
Includes 1AM1151 (90° Angle Drill)										

General:

Air Inlet Size: 1/4" NPT • Recommended Hose Size: 3/8" (10 mm) • Performance rated @ 90 psig (6.2 bar) air pressure

Standard Equipment:

Parts List • Safety and Instruction Manual

Accessories:

Drill Accessories, see pages 18 – 19



SAFETY PRECAUTION: Read and follow all safety and operating instructions.
WARNING: Face & eye protection must be worn while operating power tools, per ANSI B186.1

RIGHT ANGLE DRILLS



3A2340



SDR10A20R3



3A1240

Performance:

Power: 0.80 hp (0.60 kw) – 1 hp (0.75 kw)
 Speed Range: 300 rpm – 2200 rpm
 Chuck Capacity: 1/4" (6 mm) – 1/2" (13 mm)

Features:

Reversible and Non-Reversible
 Lever Start
 Heads can be rotated 360°
 Rear or Side Exhaust

Right Angle Drills



Model Number	Chuck Capacity		Free Speed rpm	Weight		Length		Side To Center		Maximum Air Consumption		Sound Level dB(A)	Spindle Thread
	in	mm		lb	kg	in	mm	in	mm	cfm	l/s		
.80 hp (0.60 kw) – Reversible – Side Exhaust¹													
3A2140	1/2	13.0	300	6.9	3.10	15.5	394	0.8	19	33	16	81	1/2"-20
3A2240	1/2	13.0	480	6.9	3.10	15.5	394	0.8	19	33	16	81	1/2"-20
3A2340	1/2	13.0	700	6.9	3.10	15.5	394	0.8	19	33	16	81	1/2"-20
3A2430	3/8	10.0	1000	6.3	2.90	15.4	391	0.8	19	33	16	81	1/2"-20
1 hp (0.75 kw) – Reversible													
SDR10A3R3	3/8	10	300	3.3	1.50	12.0	305	0.8	19	30	14	78	3/8"-24
SDR10A3R4	1/2	13	300	3.7	1.65	12.0	305	0.8	19	30	14	78	3/8"-24
SDR10A6R3	3/8	10	600	3.3	1.50	12.0	305	0.8	19	30	14	78	3/8"-24
SDR10A6R4	1/2	13	600	3.7	1.65	12.0	305	0.8	19	30	14	78	3/8"-24
SDR10A10R3	3/8	10	1000	3.3	1.50	12.0	305	0.8	19	30	14	78	3/8"-24
SDR10A10R4	1/2	13	1000	3.7	1.65	12.0	305	0.8	19	30	14	78	3/8"-24
SDR10A16R2	1/4	6	1600	3.2	1.40	12.0	305	0.8	19	30	14	78	3/8"-24
SDR10A16R3	3/8	10	1600	3.3	1.50	12.0	305	0.8	19	30	14	78	3/8"-24
SDR10A20R2	1/4	6	2000	2.9	1.30	11.0	280	0.8	19	30	14	78	3/8"-24
SDR10A20R3	3/8	10	2000	3.0	1.35	11.0	280	0.8	19	30	14	78	3/8"-24
1 hp (0.75 kw) – Non-Reversible													
SDR10A4N3	3/8	10	400	3.3	1.50	11.2	285	0.8	19	30	14	78	3/8"-24
SDR10A4N4	1/2	13	400	3.7	1.65	11.2	285	0.8	19	30	14	78	3/8"-24
SDR10A10N3	3/8	10	1000	3.3	1.50	11.2	285	0.8	19	30	14	78	3/8"-24
SDR10A10N4	1/2	13	1000	3.7	1.65	11.2	285	0.8	19	30	14	78	3/8"-24
SDR10A13N2	1/4	6	1300	3.2	1.40	11.2	285	0.8	19	30	14	78	3/8"-24
SDR10A13N3	3/8	10	1300	3.3	1.50	11.2	285	0.8	19	30	14	78	3/8"-24
SDR10A22N2	1/4	6	2200	2.9	1.30	10.2	260	0.8	19	30	14	78	3/8"-24
SDR10A22N3	3/8	10	2200	3.0	1.35	10.2	260	0.8	19	30	14	78	3/8"-24
SDR10A30N2	1/4	6	3000	2.9	1.30	10.2	260	0.8	19	30	14	78	3/8"-24
1 hp (0.75 kw) – Non-reversible – Side Exhaust¹													
3A1140	1/2	13.0	360	6.5	2.90	15.1	384	0.8	19	33	16	80	1/2"-20
3A1240	1/2	13.0	600	6.5	2.90	15.1	384	0.8	19	33	16	80	1/2"-20

¹ Not CE Certified

General:

Air Inlet Size: 1/4" NPT • Recommended Hose Size: 3/8" (10 mm) • Performance rated @ 90 psig (6.2 bar) air pressure

Standard Equipment:

Parts List • Safety and Instruction Manual • 3-jaw Chuck and Key

Accessories:

Drill Accessories, see pages 18 – 19



SAFETY PRECAUTION: Read and follow all safety and operating instructions.
WARNING: Face & eye protection must be worn while operating power tools, per ANSI B186.1

D-HANDLE DRILLS



1465

Performance:

Power: 1 hp (0.75 kw)
 Speed Range: 375 rpm – 2000 rpm
 Chuck Capacity: 3/8" (10 mm) – 1/2" (13 mm)

Features:

Non-Reversible
 Trigger Start
 Side Exhaust
 Support Handle Included
 Swivel Air Inlet



D-Handle Drills

Model Number	Chuck Capacity		Free Speed rpm	Weight		Length		Side To Center		Maximum Air Consumption		Sound Level dB(A)	Spindle Thread
	in	mm		lb	kg	in	mm	in	mm	cfm	l/s		
"D" Handle Drill – 1 hp (0.75 kw) – Non-reversible													
DR1467	1/2	13	375	6.6	3.0	13.4	340	1.0	25	30	14	76	1/2"-20
1466	1/2	13	550	6.6	3.0	13.4	340	1.0	25	30	14	76	1/2"-20
1465-1/2	1/2	13	1000	6.6	3.0	13.4	340	1.0	25	30	14	76	1/2"-20
1464	1/2	13	2000	6.6	3.0	13.4	340	1.0	25	30	14	76	1/2"-20
1465	3/8	10	1000	6.6	3.0	13.3	338	1.0	25	30	14	76	1/2"-20

General:

Air Inlet Size: 1/4" NPT • Recommended Hose Size: 3/8" (10 mm) • Performance rated @ 90 psig (6.2 bar) air pressure

Standard Equipment:

Parts List • Safety and Instruction Manual • 3-jaw Chuck and Key • Swivel Air Inlet

Accessories:

Drill Accessories, see pages 22 – 23

T-HANDLE DRILLS



3T1630

Performance:

Power: 1 hp (0.75 kw)
 Speed Range: 360 rpm – 2650 rpm
 Chuck Capacity: 3/8" (10 mm) – 1/2" (13 mm)

Features:

Non-Reversible
 Lever Start
 Handle Grips



T-Handle Drills

Model Number	Chuck Capacity		Free Speed rpm	Weight		Length		Side To Center		Maximum Air Consumption		Sound Level dB(A)	Spindle Thread
	in	mm		lb	kg	in	mm	in	mm	cfm	l/s		
"T" Handle Drill – 1 hp (0.75 kw) – Non-reversible													
3T1140	1/2	13	360	6.3	2.9	30	762	1.0	25	35	17	80	1/2"-20
3T1640	1/2	13	2650	7.0	3.2	30	762	1.0	25	35	17	80	1/2"-20
3T1530	3/8	10	2150	6.9	3.1	30	762	1.0	25	35	17	80	1/2"-20
3T1630	3/8	10	2650	6.9	3.1	30	762	1.0	25	35	17	80	1/2"-20

General:

Air Inlet Size: 1/4" NPT • Recommended Hose Size: 3/8" (10 mm) • Performance rated @ 90 psig (6.2 bar) air pressure

Standard Equipment:

Parts List • Safety and Instruction Manual • 3-jaw Chuck and Key • Comfort Grip

Accessories:

Drill Accessories, see pages 18 – 19



SAFETY PRECAUTION: Read and follow all safety and operating instructions.
WARNING: Face & eye protection must be worn while operating power tools, per ANSI B186.1

Z-HANDLE DRILLS

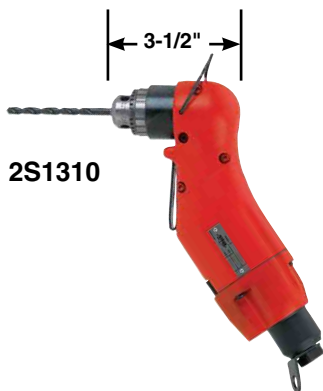

Performance:

Power: .33 hp (.25 kw) – .50 hp (.37 kw)
 Speed Range: 1000 rpm – 2200 rpm
 Chuck Capacity: 1/4" (6 mm) – 3/8" (10 mm)

Features:

Reversible and Non-Reversible
 Lever Start
 Rear Exhaust
 Suspension Bail

Z-Handle Drills



Model Number	Chuck Capacity		Free Speed	Weight		Length		Side To Center		Maximum Air Consumption		Sound Level	Spindle Thread
	in	mm	rpm	lb	kg	in	mm	in	mm	cfm	l/s	dB(A)	
Non-reversible – .50 hp (0.37 kw)													
2S1310	1/4	6	2200	2.6	1.2	3.5	89	1.0	25	18	8	75	3/8"-24
2S1330	3/8	10	2200	2.7	1.2	3.8	97	1.0	25	18	8	75	3/8"-24
Reversible – .33 hp (0.25 kw)													
2S2110	1/4	6	1000	2.6	1.2	3.5	89	1.0	25	16	8	75	3/8"-24
2S2130	3/8	10	1000	2.7	1.2	3.8	97	1.0	25	16	8	75	3/8"-24
2S2230	3/8	10	1600	2.7	1.2	3.8	97	1.0	25	16	8	75	3/8"-24
2S2310	1/4	6	2200	2.6	1.2	3.5	89	1.0	25	16	8	75	3/8"-24
2S2330	3/8	10	2200	2.7	1.2	3.8	97	1.0	25	16	8	75	3/8"-24

General:

Air Inlet Size: 1/4" NPT • Recommended Hose Size: 3/8" (10 mm) • Performance rated @ 90 psig (6.2 bar) air pressure

Standard Equipment:

Parts List • Safety and Instruction Manual • 3-jaw Chuck and Key • Suspension Bail

Accessories:

Drill Accessories, see pages 18 – 19



SAFETY PRECAUTION: Read and follow all safety and operating instructions.
WARNING: Face & eye protection must be worn while operating power tools, per ANSI B186.1

Drill Chucks & Keys

Adapts arbor with 1/2"-20 thread to hole saw with 5/8"-18 thread



Chuck Capacity	Thread Size	Chuck Part No	Key Part No	Key Holder No
0 – 1/4"	3/8"-24	21077	30000	
0 – 1/4"	3/8"-24	21019A	30202	
0 – 3/8"	1/2"-20	21002	30011	14273
0 – 3/8"	3/8"-24	21085	30231	14273
0 – 3/8"	3/8"-24	69005		
0 – 1/2"	1/2"-20	69006		
1/16" – 3/8"	1/2"-20	21131	30002	
1/16" – 3/8"	3/8"-24	21133	30002	14273
1/16" – 3/8"	3/8"-24	65562		
5/64" – 1/2"	3/8"-24	21132	30429	
5/64" – 1/2"	1/2"-20	21137	30011	14273

¹Keyless Chuck • Keyed chucks include key

Quick Change Chuck

Part No 2352

Adapts 3/8"-24 threaded spindles to 1/4" hex quick change



Non-Reversing Only

Support Handle

Part No 2355B

For use on ES, 2L, 3P series drills



Signature Series Support Handle

Part No SPSDR-14A

For use on Signature Series Drills

Part No 77067A

Heavy Duty Support Handle for Signature Series Drills



1410 Series Chuck Shroud

Part No 68808

For use on 1410, 1412

Part No 68809

For use on 1407, 1410R, 1412R

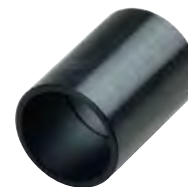

Comfort Grips

For use on 1SM & 1ST series drills



66124

For use on 10M & 10T series drills



68340

For use on ES series drills



67806

For use on Signature series drills



SDR6PNBOOT / SDR10PNBOOT



SAFETY PRECAUTION: Read and follow all safety and operating instructions.
WARNING: Face & eye protection must be worn while operating power tools, per ANSI B186.1

Vacforce

Part No 1557



*Drill Sold Separately

2" Stroke

Length		Width		Weight		Air Supply	Inlet
in	mm	in	mm	lb	kg		
11.0	280	3.75	95	7.6	3.5	2.0 CFM	1/4" NPT

Standard Accessories: Adapter Shims • 5 mm Hex Key Stored in vacuum base.

Cutter Kit

Part No 278



Sioux Part Number	Broach Cutter Size – Imperial
HB437	7/16"
HB500B	1/2"
HB562	9/16"
HB625	5/8"
HB750	3/4"
HB875	7/8"
HB100B	1"

Kit Includes:

HB01 – Arbor, HB02 – Pin, HB03 – Hex Key

Case

5 Cutters (1/2", 9/16", 5/8", 3/4", 7/8")

Pipe-Vac Adapter

Part No 1557P



Up to 12" Pipe Diameter

*Drill Sold Separately

Depth Control Attachment

Part No 1557DC

Depth control attachment for use with Vac-Force model 1557



SR Cutters



SR40



SR83

Sioux Part Number	Description
SR40	#3 (.40") SR Cutter
SR83	#8 (.83") SR Cutter

Sold in case of 40



SAFETY PRECAUTION: Read and follow all safety and operating instructions.
WARNING: Face & eye protection must be worn while operating power tools, per ANSI B186.1

ASSEMBLY



Index

Screwdrivers	25 – 29
Nutrunners	29
Ratchet Wrenches	30
Impact Wrenches	32 – 33

Impact Drivers	34
Torque Multipliers & Accessories	35 – 38
Assembly Accessories	38 – 39

ASSEMBLY

Combining Efficiency, Reliability and Value...

Putting it all together

To keep up with the rapidly growing demands of modern assembly applications, Sioux Tools remains on the cutting edge of engineering design. We continue to be innovative in creating new tools to provide faster rundown speeds with exceptional accuracy and consistent torque delivery, combined with ergonomic design for operator comfort and safety.

We build every tool to help assembly operators become more productive. We believe they deserve tools that will help improve their quality of performance and maximize the skills they bring to the job.

Exclusive Designs

Sioux Tools is the exclusive manufacturer of the Z-handle. This unique feature allows access to tight, hard to reach angles.

Impact Wrenches

Suitable for general assembly, repair jobs etc. When you require a powerful, lightweight tool, with little reaction force and moderate accuracy. This is the best choice for loosening joints.

Screwdrivers

Sioux Tools offers a wide range of screwdrivers designed to meet today's fast paced, high output assembly and manufacturing applications.

Nutrunners

Sioux offers nutrunners that are designed for high volume industrial production. You can choose from free speeds of up to 2200 rpm, and a torque range of up to 600 in lb (68 Nm). These are outstanding tools for fast accurate assembly.

Assembly Safety

Broken sockets, bits and adapters can cause injury.

Proper eye protection must be worn at all times by tool user and bystanders. Use only sockets, bits and adapters made for power tools and that are in good condition. Use only bits and adapters that are in good condition. Keep hands away from sockets, bits and adapters.

Sudden and unexpected tool movement can cause injury.

Be sure your body position allows you to have control of the tool at all times. Make sure your footing is secure. Consult manufacturer for proper reaction bar if movement is excessive.

Tools starting unexpectedly can cause injury.

Always remove the tool from air supply and activate trigger to bleed air line before making any adjustments, changing accessories, or doing any maintenance or service on the tool.

Falling tools can cause injury.

If the tool is used with a balancer or other suspension device, be sure the tool is firmly attached to the device.

Assembly Principles of Operation

An air motor and planetary reduction gearing are used to drive a clutch spindle, producing torque in a fastener.

The action of the torque creates clamp-load in the assembly.

Motor size (horsepower), gear ratio, and type of clutch determine performance, and are key factors in selecting the appropriate tool for a given application.

Generally equipped with a 1/4" female hexagon spindle that allows inserting a screwdriver bit.

An Easy Drive Home



Sioux Tools offers a wide range of screwdrivers and nutrunners designed to meet today's fast paced, high output assembly and manufacturing applications. Sioux Tools is able to provide a perfect match for any job requirement. As industries strive to reduce fastener requirements, we work to meet the demand for greater accuracy and precision in fastening performance. The productivity demands for quality and speed, as well as user comfort, convenience and safety make Sioux Tools your number one choice.

Configurations

Sioux screwdrivers are available in pistol grip, inline, right angle and our exclusive Z-handle configurations. Most screwdriver models offer your choice of Quick Change or Locking Internal Hex spindles. The spring-loaded chuck on the Quick Change



allows for fast, easy bit changes without the need for additional tools or hardware. The slimmer design of the Locking Internal Hex ensures that the bit stays firmly in place until you choose to remove it with the aid of a vise or pliers.

Reducing Physical Load

We design all our screwdrivers with ergonomics in mind. We help you get the job done with a minimum amount of effort and wear and tear on the operator. By reducing the physical load on the operator, which includes noise and oil mist, productivity will be improved. Sioux Tools offers many benefits including high torque accuracy, low sound levels and ergonomic grips. Fast clutch shutoff reduces reaction force, while the shape reduces the amount of gripping and trigger force required.

Clutch Selection

Positive Clutch – Spindle will not turn with motor until operator exerts forward pressure on spindle engaging the clutch. The clutch ratchets when torque resistance from the fastener overcomes the forward pressure and the jaws begin to cam apart. Torque output of the tool is determined by forward pressure from operator and by the cam angle of the clutch jaws. For wood, sheet metal, and machine screws and lag bolts.

Sioux Tools is the exclusive manufacturer of three different positive clutches; Low, Mid and High torque output. Your choice of clutch allows you to more precisely control the amount of torque exerted on the fastener.

Stall Drive – Spindle is coupled directly with the output of the motor. Final torque is reached when resistance of the fastener overcomes the torque output of the motor. Final torque can be influenced by air pressure and/or operator twisting the tool. For







prevailing torque or soft pull applications involving machine, wood, or self-tapping screws.

Adjustable Clutch – Spindle will not turn with motor until operator exerts forward pressure on spindle engaging the clutch. When fastener is tight, clutch will ratchet. Adjusting spring pressure will effect final output torque. Offers consistent torque control with little operator reaction.

Torque Control – Motor shuts off automatically when fastener is tight. Adjusting spring pressure changes final output torque for critical torque requirements. Perfect for applications with little or no prevailing torque where final torque is substantially higher than rundown torque.

Direct Clutch – Spindle will not turn with motor until operator exerts forward pressure on spindle engaging the clutch. Final torque is reached when resistance of the fastener overcomes the torque output of the motor. Excellent stall type tool when tightening group of fasteners without turning off motor.

Clutch Selection Guide

Type of Job	Clutch Performance			
	Torque Control	Adjustable	Direct/Stall Drive	Positive Clutch
<p>1. Free-Running – Sudden Stop</p>  <p>Turns easily until screw head or nut seats against a solid stop. Resistance then builds up suddenly.</p>	Excellent for all size screws.	Good for all size screws. Close torque control is not required.	Good for large or medium nuts or cap screws only.	Fair for all size screws where close torque accuracy is not required.
<p>2. Soft Pull-Up</p>  <p>Turns easily until screw head or nut seats, then resistance builds up gradually through one or more turns as resilient material compressed.</p>	Excellent for all size screws.	Good for most screws. Close torque control is not required. Slow on large screws with long pull-up.	Good for large and medium size screws. Must be adjusted to run rather slowly for small screws.	Good for small to medium size screws. Requires considerable operator pressure on large screws.
<p>3. Self-Tapping in Thick Material</p>  <p>Increasing heavy resistance through entire travel until screw head seats. Then either (A) gradual, or (B) sudden final build-up resistance.</p>	Excellent for all size screws. Not suitable if tapping torque exceeds stripping torque.	Good for most screws. With proper operator technique, can be used where tapping torque exceeds stripping torque. Slow on large screws.	Not recommended unless stripping torque is considerably higher than tapping torque.	Good for most size screws where stripping torque is considerably higher than tapping torque. Excellent in non-uniform or misaligned material.
<p>4. Sheet Metal Screws</p>  <p>Resistance increases rapidly at first, then eases slightly. At the end, it usually builds up suddenly when screw head seats.</p>	Good for all size screws. Not suitable if tapping torque exceeds stripping torque.	Good for most screws. With proper operator technique, can be used where tapping torque exceeds stripping torque.	Not recommended unless stripping torque is considerably higher than tapping torque.	Good for all size screws where stripping torque is considerably higher than tapping torque. Excellent when sheets are frequently misaligned.
<p>5. Lock Nuts</p>  <p>Starts with heavy resistance that last through entire travel until screw or nut seats. Then either (A) gradual, or (B) sudden further build-up resistance.</p>	Excellent for all size screws.	Good for most screws. Close torque control is not required.	Good for large and medium screws. Must be adjusted to run rather slowly for small screws.	Fair for all size screws.
<p>6. Wood Screws</p>  <p>Starts with small resistance that steadily increases through entire travel with additional resistance as screw head seats.</p>	Fair for all size screws.	Good for all size screws.	Excellent for large and medium screws. Must be adjusted to run rather slowly for small screws.	Excellent for all size screws.

Tool Selection Guide

Considerations for Selecting Screwdrivers

This should be done in a systematic way to ensure no details are overlooked that could have an adverse affect on job function or results. The following are variables that must be considered to ensure proper tool selection.

- What is being assembled?
- What material is involved?
- What type of screw or nut is being driven? What head type?
- What screw size (standard or metric)?
- What U.S. grade or metric class?
- What torque (inch pounds or Newton meters)?
- What torque tolerance (accuracy)?
- What is the run-down torque vs. seating torque?
- What type of joint pull-up (hard, medium, soft)?
- What pull-up conditions (free run-down, sheet metal, wood, or plastic)?
- What is the production rate?
- Are there clearance problems?
- What handle style is required (straight or pistol)?
- Is the tool to be hand held or fixtured?
- What type of clutch?
- Speed required?
- Is there a need for a reversible tool?
- What type of drive (square, 1/4" hex, quick change)?
- How is the application being done now?
- Special consideration?

What is the size and type of screw or fastener on which the tool will be used?

No 1 Series Tools – 2 to 50 in lb of torque. (Fasteners up to 1/4")

.6 & 1 HP Signature Series Tools – 5 to 400 in lbs of torque. (Fasteners up to 3/8")

No 3 Series Tools – 5 to 50 ft lbs of torque. (Fasteners up to 1/2")

What kind of application and material will the fastener be used on?

The type of material helps to determine which type of clutch is needed.

Application & Material Guide

Screw Size				
	Clutch	Free Run Down	Soft Pull-Up	Prevailing Torque
No 8 and Smaller				
	Adjustable	Excellent	Excellent	Excellent
	Stall	Excellent	Good	Excellent
	Direct	Good	Good	Good
	Positive	Fair	Fair	Good
No 10 and Larger				
	Adjustable	Good	Fair	Fair
	Stall	Good	Excellent	Excellent
	Direct	Good	Excellent	Excellent
	Positive "P"	Good	Excellent	Excellent
	Positive "PS"	Good	Excellent	Excellent

What are the torque requirements?

Most air tools share the quality: as the speed increases, the torque decreases. This applies to tools within the same horsepower rating.

- A.** Stall or direct clutch gives the most torque.
- B.** Positive clutch tools are operator influenced.
- C.** Adjustable torque clutches are available on most Sioux fastening tools.
- D.** Torque control is available on No 1

At what angle or position will the tool be used?

This will determine the style of tool best suited from an ergonomics point of view.

- A.** If the fastener is in a vertical position, a straight or lever style tool will be best.
- B.** If the fastener is in a horizontal position a pistol style tool will be best.
- C.** If the fastener is in a tight or constricted area the "2S" series works well in this application.

Is reversing necessary?

Most fastening applications are going to require a reversible tool. Keep in mind that in most cases a non-reversing tool will have more torque than a reversible tool.

Is the application operator influenced or restricted?

- A.** Is the operator male or female? This can be a factor in determining the size of the power tool (weight for example).
- B.** Does the application lend itself to an auto start tool, as in the No 1 series?

An example of applying these questions to an application would be:

Driving a 2" long wood screw into hardwood with a pilot hole. The fastener is in a horizontal position during assembly. A test with a hand torque wrench indicates a prevailing torque of 80 in lbs, and a failing torque of 120 in lbs.

- 1.** 2" long wood screw
- 2.** Hard Wood use positive clutch
- 3.** SSD10P20PS – 100 in lbs
- 4.** Pistol will work best
- 5.** Need reversing
- 6.** Mostly male workers





























Screwdriver Maintenance



- 1 Tipper valve and valve seat is easily accessible for service
- 2 Slip fit of front end plate bearing allows easy service of the air motor without disturbing the rotor spacing
- 3 Rotor pinion is case hardened to resist wear
- 4 Grease zerk makes it easy to grease the gears without disassembly
- 5 Ring gear is machined into the motor retainer for ease of assembly and disassembly
- 6 Planet gear pins are slip fit for ease of assembly and disassembly
- 7 Interchangeable rotor, cylinder, bearings and end plates. This reduces the number of spare parts tool cribs need to stock

Guide to Fasteners

Guide To Fasteners

Screw Type	Standard Nosepieces Available For All Fasteners Shown Below				
Wood Screws	 flat head	 round head	 oval head		
Machine Screws	 round head	 flat head	 fillister head	 oval head	
* Standard or Special, depending on the washer diameter.	 truss head	 binding head	 washer head*	 pan head	
	 flat side binding head	 fillister pan head	 flat fillister head	 undercut flat head	
	 knob screw head	 lentil head	 Jackson head	 undercut oval head	
Tapping or Sheet Metal Screws	 round head	 flat head	 oval head	 pan head	 truss head
Drive Systems	Standard			Special*	
* Special bits required for Clutch and Torx internal and external. Call factory.	 Phillips	 Reed-Prince	 slotted	 clutch	 Torx

POSITIVE CLUTCH PISTOL GRIP & T-HANDLE SCREWDRIVERS



SSD6P20P



1OM2403



SSD10P20PS



3T2303

Performance:

Torque: 24 in lb (2.7 Nm) – 216 in lb (24.4 Nm)
Speed: 725 rpm – 2500 rpm

Features:

Reversible and Non-reversible
Trigger Start
Trigger or Shuttle Reverse
Comfort Grip
Rotatable Exhaust (1OM series)

Positive Clutch Pistol Grip & T-Handle Screwdrivers

Model Number	Max Torque ¹ (Soft Joint)		Free Speed	Weight		Length		Side To Center		Air Consumption		Sound Level
	in lb	Nm		rpm	lb	kg	in	mm	in	mm	cfm	
1 Series – Rapid Reverse – 1/4" Quick Change												
1OM2103	55	6.2	725	1.8	0.80	7.7	196	0.7	17	8	4	75
1OM2203	40	4.5	1000	1.8	0.80	7.7	196	0.7	17	8	4	75
1OM2303	30	3.4	1400	1.8	0.80	7.7	196	0.7	17	8	4	75
1OM2403	24	2.7	2000	1.6	0.70	6.7	170	0.7	17	8	4	75
.6 HP Medium Clutch Screwdrivers – 1/4" Quick Change												
SSD6P12P	100	11.3	1200	2.6	1.18	8.6	218	0.8	20	25	12	80
SSD6P20P	55	6.2	2000	2.2	0.98	6.8	171	0.8	20	25	12	80
SSD6P25P	40	4.5	2500	2.2	0.98	6.8	171	0.8	20	25	12	80
1 HP Medium Torque Clutch Screwdrivers – 1/4" Quick Change												
SSD10P12P	135	15.3	1200	2.8	1.30	9.1	231	0.8	20	30	14	80
SSD10P20P	70	7.9	2000	2.4	1.07	7.3	185	0.8	20	30	14	80
SSD10P25P	50	5.7	2500	2.4	1.07	7.3	185	0.8	20	30	14	80
1 HP High Torque Clutch Screwdrivers – 1/4" Quick Change												
SSD10P12PS	145	16.4	1200	2.8	1.30	9.1	231	0.8	20	30	14	80
SSD10P20PS	80	9.0	2000	2.4	1.07	7.3	185	0.8	20	30	14	80
SSD10P25PS	58	6.5	2500	2.4	1.07	7.3	185	0.8	20	30	14	80
3 Series T-Handle – 7/16" Quick Change												
3T2303	216	24.4	850	6.7	3.00	33.0	840	1.0	25	33	16	81

¹ Torque output varies with force exerted by operator

General:

Air Inlet Size: 1/4" NPT • Recommended Hose Size: 1/4" (6 mm)(1OM series) • Performance rated @ 90 psig (6.2 bar) air pressure

Standard Equipment:

Parts List • Safety and Instruction Manual • Comfort Grip (1OM series)

Accessories:

Screwdriver Accessories, Screwdriver Bits and Finders see pages 38 – 39

POSITIVE CLUTCH INLINE SCREWDRIVERS

Performance:

Torque: 55 in lb (6.2 Nm)
Speed: 800 rpm

Features:

Reversible
Lever Start
Rear Exhaust



1SM2103

Positive Clutch Inline Screwdrivers

Model Number		Max Torque ¹ (Soft Joint)		Free Speed	Weight		Length		Side To Center		Air Consumption		Sound Level
1/4" Quick Change	1/4" Internal Hex	in lb	Nm		rpm	lb	kg	in	mm	in	mm	cfm	
Inline													
1SM2103		55	6.2	800	1.4	0.6	9.1	231	0.6	15	8	4	75

¹ Torque output varies with force exerted by operator

General:

Air Inlet Size: 1/4" NPT • Recommended Hose Size: 1/4" (6 mm)(1SM series) • Performance rated @ 90 psig (6.2 bar) air pressure

Standard Equipment:

Parts List • Safety and Instruction Manual • Comfort Grip (1SM series)

Accessories:

Screwdriver Accessories, Screwdriver Bits and Finders see pages 38 – 39



SAFETY PRECAUTION: Read and follow all safety and operating instructions.
WARNING: Face & eye protection must be worn while operating power tools, per ANSI B186.1

STALL PISTOL GRIP SCREWDRIVERS



Performance:

Torque: 18 in lb (2.0 Nm) – 400 in lb (45.2 Nm)
Speed: 300 rpm – 2600 rpm

Features:

Reversible
Trigger Start
Rapid or Shuttle Reverse
Comfort Grip
1/4" Quick Change

Stall Pistol Grip Screwdrivers

Model Number	Max Torque (Soft Joint)		Free Speed rpm	Weight		Length		Side To Center		Air Consumption		Sound Level dB(A)
	in lb	Nm		lb	kg	in	mm	in	mm	cfm	l/s	
Trigger Start – Trigger Reverse												
1OM2107	55	6.2	725	1.8	0.80	7.7	196	0.7	18	8	4	75
1OM2207	40	4.5	1000	1.8	0.80	7.7	196	0.7	18	8	4	75
1OM2307	30	3.4	1400	1.8	0.80	7.7	196	0.7	18	8	4	75
1OM2407	24	2.7	2000	1.6	0.70	6.7	170	0.7	18	8	4	75
1OM2507	18	2.0	2600	1.6	0.70	6.7	170	0.7	18	8	4	75
.6 HP Trigger Start – Shuttle Reverse												
SSD6P7S	155	17.8	700	2.4	1.10	6.8	171	0.8	20	25	12	80
SSD6P12S	100	11.3	1200	2.4	1.10	6.8	171	0.8	20	25	12	80
SSD6P20S	55	6.2	2000	2.0	0.90	5.8	146	0.8	20	25	12	80
SSD6P25S	40	4.5	2500	2.0	0.90	5.8	146	0.8	20	25	12	80
1 HP Trigger Start – Shuttle Reverse												
SSD10P3S	400	45.2	300	2.6	1.17	7.5	191	0.8	20	30	14	80
SSD10P5S	325	36.7	500	2.6	1.17	7.5	191	0.8	20	30	14	80
SSD10P7S	220	24.9	700	2.6	1.17	7.5	191	0.8	20	30	14	80
SSD10P12S	145	16.4	1200	2.6	1.17	7.5	191	0.8	20	30	14	80
SSD10P20S	80	9.0	2000	2.2	0.98	6.5	165	0.8	20	30	14	80
SSD10P25S	58	6.6	2500	2.2	0.98	6.5	165	0.8	20	30	14	80

General:

Air Inlet Size: 1/4" NPT • Recommended Hose Size: 1/4" (6 mm)(1OM series); 3/8" (10 mm) • Performance rated @ 90 psig (6.2 bar) air pressure

Standard Equipment:

Parts List • Safety and Instruction Manual • Comfort Grip

Accessories:

Screwdriver Accessories, Screwdriver Bits and Finders see pages 38 – 39

STALL INLINE SCREWDRIVERS

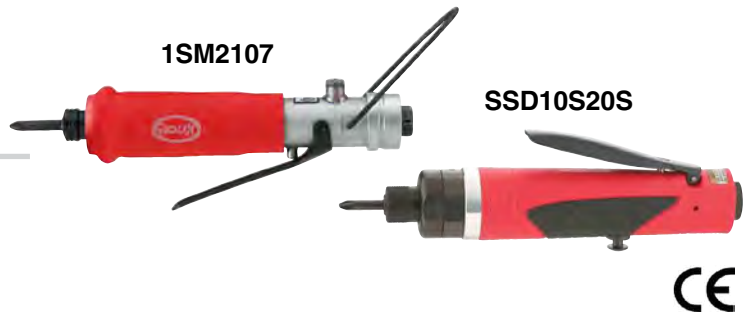

Performance:

Torque: 24 in lb (2.7 Nm) – 400 in lb (45.2 Nm)
Speed: 300 rpm – 2500 rpm

Features:

Reversible
Lever Start
Rear Exhaust
Suspension Bail
1/4" Quick Change

Stall Inline Screwdrivers

Model Number	Max Torque (Soft Joint)		Free Speed rpm	Weight		Length		Side To Center		Air Consumption		Sound Level dB(A)
	in lb	Nm		lb	kg	in	mm	in	mm	cfm	l/s	
Inline – Reversible – 1/4" Quick Change Drive												
1SM2107	55	6.2	800	1.4	0.60	9.1	231	0.6	15	8	4	75
1SM2407	24	2.7	2200	1.3	0.60	8.1	206	0.6	15	8	4	75
Inline – Stall Clutch												
SSD10S3S	400	45.2	300	2.2	1.00	9.5	240	0.8	20	30	14	80
SSD10S5S	325	36.7	500	2.2	1.00	9.5	240	0.8	20	30	14	80
SSD10S7S	220	24.9	700	2.2	1.00	9.5	240	0.8	20	30	14	80
SSD10S12S	145	16.4	1200	2.2	1.00	9.5	240	0.8	20	30	14	80
SSD10S20S	80	9.0	2000	1.9	0.85	8.4	215	0.8	20	30	14	80
SSD10S25S	58	6.6	2500	1.9	0.85	8.4	215	0.8	20	30	14	80

General:

Air Inlet Size: 1/4" NPT • Recommended Hose Size: 1/4" (6 mm)(1SM series); 3/8" (10 mm)(SSD series) • Performance rated @ 90 psig (6.2 bar) air pressure

Standard Equipment:

Parts List • Safety and Instruction Manual • Comfort Grip (1SM series) • Suspension Bail

Accessories:

Screwdriver Accessories, Screwdriver Bits and Finders see pages 38 – 39



SAFETY PRECAUTION: Read and follow all safety and operating instructions.
WARNING: Face & eye protection must be worn while operating power tools, per ANSI B186.1

ADJUSTABLE CLUTCH PISTOL GRIP SCREWDRIVERS



Performance:

Torque: 20 in lb (2.3 Nm) – 140 in lb (15.8 Nm)
 Speed: 300 rpm – 2500 rpm

Features:

- Reversible
- Trigger Start
- Rapid or Shuttle
- Reverse
- Comfort Grip

Adjustable Clutch Pistol Grip Screwdrivers

Model Number	Max Torque (Soft Joint)		Free Speed rpm	Weight		Length		Side To Center		Air Consumption		Sound Level dB(A)
	in lb	Nm		lb	kg	in	mm	in	mm	cfm	l/s	
Trigger Start – Rapid Reverse												
1OM2105Q	50	5.7	725	2.1	0.95	8.8	224	0.7	17	8	4	75
1OM2205Q	35	4.0	1000	2.1	0.95	8.8	224	0.7	17	8	4	75
1OM2305Q	25	2.8	1400	2.1	0.95	8.8	224	0.7	17	8	4	75
1OM2405Q	20	2.3	2000	1.9	0.86	7.8	198	0.7	17	8	4	75
.6 HP Trigger Start – Shuttle Reverse												
SSD6P7AC	140	15.8	700	3.0	1.36	10.3	262	0.8	20	25	12	80
SSD6P12AC	100	11.3	1200	3.0	1.36	10.3	262	0.8	20	25	12	80
SSD6P20AC	55	6.2	2000	2.6	1.16	8.5	216	0.8	20	25	12	80
SSD6P25AC	40	4.5	2500	2.6	1.16	8.5	216	0.8	20	25	12	80
1 HP Trigger Start – Shuttle Reverse												
SSD10P3AC	140	15.8	300	3.2	1.45	10.2	259	0.8	20	30	14	80
SSD10P5AC	140	15.8	500	3.2	1.45	10.2	259	0.8	20	30	14	80
SSD10P7AC	140	15.8	700	3.2	1.45	10.2	259	0.8	20	30	14	80
SSD10P12AC	120	13.5	1200	3.2	1.45	10.2	259	0.8	20	30	14	80
SSD10P20AC	80	9.0	2000	2.8	1.25	8.4	213	0.8	20	30	14	80
SSD10P25AC	60	6.8	2500	2.8	1.25	8.4	213	0.8	20	30	14	80

General:

Air Inlet Size: 1/4" NPT • Recommended Hose Size: 1/4" (6 mm)(1OM series); 3/8" (10 mm) • Performance rated @ 90 psig (6.2 bar) air pressure

Standard Equipment:

Parts List • Safety and Instruction Manual • Comfort Grip • Clutch Adjustment Wrench

Accessories:

Screwdriver Accessories, Screwdriver Bits and Finders see pages 38 – 39

Performance:

Torque: 20 in lb (2.3 Nm) – 140 in lb (15.8 Nm)
 Speed: 300 rpm – 2500 rpm

Features:

- Reversible
- Rear Exhaust
- External Clutch Adjustment

ADJUSTABLE CLUTCH INLINE SCREWDRIVERS



Adjustable Clutch Inline Screwdrivers

Model Number		Max Torque (Soft Joint)		Free Speed rpm	Weight		Length		Side To Center		Air Consumption		Sound Level dB(A)
1/4" Quick Change	1/4" Internal Hex	in lb	Nm		lb	kg	in	mm	in	mm	cfm	l/s	
Inline – Lever Start													
		50	5.7	800	1.6	0.70	10.3	262	0.6	15	8	4	75
		35	4.0	1100	1.6	0.70	10.3	262	0.6	15	8	4	75
		25	2.8	1500	1.6	0.70	10.3	262	0.6	15	8	4	75
	1SM2405	20	2.3	2200	1.4	0.60	9.3	236	0.6	15	8	4	75
Inline – Lever Start													
		140	15.8	300	2.8	1.25	12.3	315	0.8	20	30	14	80
		140	15.8	500	2.8	1.25	12.3	315	0.8	20	30	14	80
		140	15.8	700	2.8	1.25	12.3	315	0.8	20	30	14	80
		120	13.5	1200	2.8	1.25	12.3	315	0.8	20	30	14	80
		80	9.0	2000	2.5	1.15	11.2	285	0.8	20	30	14	80
		60	6.8	2500	2.5	1.15	11.2	285	0.8	20	30	14	80

General:

Air Inlet Size: 1/4" NPT • Recommended Hose Size: 1/4" (6 mm)(1SM series); 3/8" (10 mm)(SSD series) • Performance rated @ 90 psig (6.2 bar) air pressure

Standard Equipment:

Parts List • Safety and Instruction Manual • Comfort Grip (1SM series) • Suspension Bail • Clutch Adjustment Wrench

Accessories:

Screwdriver Accessories, Screwdriver Bits and Finders see pages 38 – 39



SAFETY PRECAUTION: Read and follow all safety and operating instructions.
WARNING: Face & eye protection must be worn while operating power tools, per ANSI B186.1

TORQUE CONTROL SCREWDRIVERS

Performance:

Torque: 5.0 in lb (0.6 Nm) – 50 in lb (5.5 Nm)
 Speed: 300 rpm – 2800 rpm

Features:

Push-to-Start
 Reversible
 Locking Button Reverse
 External Clutch Adjustment



Torque Control Screwdrivers

Model Number		Max Torque (Soft Joint)		Free Speed	Weight		Length		Side To Center		Air Consumption		Sound Level
1/4" Quick Change	1/4" Internal Hex	in lb	Nm	rpm	lb	kg	in	mm	in	mm	cfm	l/s	dB(A)
Inline – Push To Start													
1ST2108Q	1ST2108	5.0-50	0.6-5.5	800	1.6	0.7	9.3	236	0.6	15	8	4	75
1ST2208Q		5.0-35	0.6-4.0	1100	1.6	0.7	9.3	236	0.6	15	8	4	75
1ST2308Q		5.0-25	0.6-3.0	1500	1.6	0.7	9.3	236	0.6	15	8	4	75
1ST2508Q		5.0-14	0.6-1.5	2800	1.4	0.6	8.3	211	0.6	15	8	4	75
Pistol Grip – Push To Start													
10T2108Q		5.0-50	0.6-5.5	725	2.1	1.0	8.8	225	0.7	17	10	5	75
10T2208Q		5.0-35	0.6-4	1000	2.1	1.0	8.8	225	0.7	17	10	5	75
10T2308Q		5.0-25	0.6-3	1400	2.1	1.0	8.8	225	0.7	17	10	5	75
10T2508Q		5.0-14	0.6-1.5	2600	1.9	0.9	7.8	200	0.7	17	10	5	75

General:

Air Inlet Size: 1/4" NPT • Recommended Hose Size: 1/4" (6 mm)(10T, 1ST series) • Performance rated @ 90 psig (6.2 bar) air pressure

Standard Equipment:

Parts List • Safety and Instruction Manual • Comfort Grip (10T, 1ST series) • Suspension Bail (Inline models)

Accessories:

Screwdriver Accessories, Screwdriver Bits and Finders see pages 38 – 39

Z-HANDLE SCREWDRIVERS

Performance:

Torque: 36 in lb (4.1 Nm) – 70 in lb (7.9 Nm)
 Speed: 1000 rpm – 2200 rpm

Features:

Lever Start
 Rear Exhaust

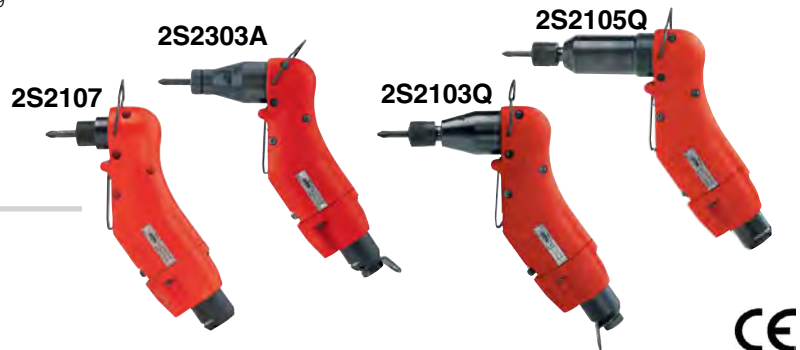

Z-Handle Screwdrivers

Model Number		Max Torque ¹ (Soft Joint)		Free Speed	Weight		Length		Side To Center		Air Consumption		Sound Level	
1/4" Quick Change	1/4" Internal Hex	in lb	Nm	rpm	lb	kg	in	mm	in	mm	cfm	l/s	dB(A)	
Z-Handle – Stall														
2S2107		70	7.9	1000	2.3	1.0	2.9	74	0.9	23	16	8	75	
2S2207		50	5.7	1600	2.3	1.0	2.9	74	0.9	23	16	8	75	
2S2307		36	4.1	2200	2.3	1.0	2.9	74	0.9	23	16	8	75	
Z-Handle – Lever Start – Reversible – Direct Clutch														
	2S2201	50	5.7	1600	2.6	1.2	4.3	109	0.9	23	16	8	75	
	2S2301	36	4.1	2200	2.6	1.2	4.3	109	0.9	23	16	8	75	
Z-Handle – Low Torque Clutch¹														
	2S2103Q	60	6.8	1000	2.6	1.2	4.3	109	0.9	23	16	8	75	
	2S2203	46	5.2	1600	2.3	1.2	4.3	109	0.9	23	16	8	75	
Z-Handle – Mid-Torque Clutch¹														
	2S2103AQ	60	6.8	1000	2.6	1.2	4.3	109	0.9	23	16	8	75	
	2S2203AQ	46	5.2	1600	2.6	1.2	4.3	109	0.9	23	16	8	75	
	2S2303AQ	2S2303A	30	3.4	2200	2.6	1.2	4.3	109	0.9	23	16	8	75
Z-Handle – Lever Start – Adjustable Clutch														
	2S2105Q	60	6.8	1000	2.9	1.3	5.8	147	0.9	23	16	8	75	
	2S2305Q	30	3.4	2200	2.9	1.3	5.8	147	0.9	23	16	8	75	

¹ Torque output varies with force exerted by operator

General:

Air Inlet Size: 1/4" NPT • Recommended Hose Size: 3/8" (10 mm) • Performance rated @ 90 psig (6.2 bar) air pressure

Standard Equipment:

Parts List • Safety and Instruction Manual • Suspension Bail

Accessories:

Screwdriver Accessories, Screwdriver Bits and Finders see pages 38 – 39



SAFETY PRECAUTION: Read and follow all safety and operating instructions.
WARNING: Face & eye protection must be worn while operating power tools, per ANSI B186.1



RIGHT ANGLE SCREWDRIVERS



Performance:

Torque: 35 in lb (4.0 Nm) – 400 in lb (45.2 Nm)
Speed: 300 rpm – 2000 rpm

Features:

Stall Drive & Adjustable Clutch
Button Reverse
Lever Start
Rear Exhaust

Right Angle Screwdrivers

Model Number		Max Torque (Soft Joint)		Free Speed	Weight		Length		Side To Center		Air Consumption		Sound Level
1/4" Quick Change	1/4" Internal Hex	in lb	Nm	rpm	lb	kg	in	mm	in	mm	cfm	l/s	dB(A)
Stall Drive													
	1AM2101	50	5.7	800	1.5	0.70	10.0	254	0.3	8	8	4	75
	1AM2201	35	4.0	1100	1.5	0.70	10.0	254	0.3	8	8	4	75
Adjustable Clutch													
	1AM2105	50	5.7	800	1.9	0.90	11.8	300	0.3	8	8	4	75
	1AM2205	35	4.0	1100	1.9	0.90	11.8	300	0.3	8	8	4	75

General: Air Inlet Size: 1/4" NPT • Recommended Hose Size: 1/4" (6 mm)(1AM series); 3/8" (10 mm)(SSD series) • Performance rated @ 90 psig (6.2 bar) air pressure

Standard Equipment: Comfort Grip (1AM series)

Accessories: Screwdriver Accessories, Screwdriver Bits and Finders see pages 38 – 39



RIGHT ANGLE NUTRUNNERS



Performance:

Torque: 20 in lb (2.3 Nm) – 600 in lb (68 Nm)
Speed: 300 rpm – 2000 rpm

Features:

Reversible
Lever Start
Rear and Side Exhaust

Right Angle Nutrunners

Model Number	Bolt Capacity ²		Max Torque (Soft Joint)		Free Speed	Weight		Length		Side To Center		Sound Level	Drive Size	
	in	mm	in lb	Nm	rpm	lb	kg	in	mm	in	mm	dB(A)	in	mm
Torque Control Clutch														
3A2108 ¹	3/8	M10	360	41	300	7.4	3.40	18.3	465	0.8	20	81	1/2	13
3A2208 ¹	3/8	M10	294	33	480	7.4	3.40	18.3	465	0.8	20	81	1/2	13
Adjustable Clutch														
1AM2106	#10	M4.5	50	5.7	800	1.9	0.90	11.6	295	0.3	8	75	1/4	6
Stall Drive														
1AM2102	#10	M4.5	50	5.7	800	1.5	0.70	11.5	292	0.3	8	75	1/4	6
Stall Drive														
3A2104 ¹	7/16	M11	600	68	300	5.5	2.50	15.5	394	0.8	20	81	1/2	13
Stall Drive														
SNR10A3S	3/8	M10	400	45.2	300	2.9	1.30	12.0	305	0.8	20	80	3/8	10
SNR10A5S	3/8	M10	325	36.7	500	2.9	1.30	12.0	305	0.8	20	80	3/8	10
SNR10A6S	3/8	M10	220	24.9	600	2.9	1.30	12.0	305	0.8	20	80	3/8	10
SNR10A10S	5/16	M8	145	16.4	1000	2.9	1.30	12.0	305	0.8	20	80	3/8	10
SNR10A16S	1/4	M6	80	9.0	1600	2.6	1.15	11.0	280	0.8	20	80	3/8	10
SNR10A20S	#10	M4.5	58	6.6	2000	2.6	1.15	11.0	280	0.8	20	80	1/4	6

¹ Not CE Certified

² Bolt capacities are based on suggested assembly torques applied to SAE Grade 5 and metric Class 9.8 fasteners under slightly lubricated conditions.

General: Air Inlet Size: 1/4" NPT • Recommended Hose Size: 1/4" (6 mm)(1AM series); 3/8" (10 mm)(SNR, 3A series) • Performance rated @ 90 psig (6.2 bar) air pressure

Standard Equipment: Parts List • Safety and Instruction Manual • Comfort Grip (1AM series) • Clutch Adjustment Wrench

Accessories: Nutrunner Accessories, see pages 38 – 39



SAFETY PRECAUTION: Read and follow all safety and operating instructions.
WARNING: Face & eye protection must be worn while operating power tools, per ANSI B186.1

RATCHET WRENCHES

Performance:

Power: 0.3 hp (0.25 kw)
Torque: 35 ft lb (47 Nm)

Features:

Lever Start
Teasing Throttle
Comfort Grip



SRW03S-25

Ratchet Wrenches

Model Number	Drive Size		Torque		Free Speed	Weight		Length		Side to Center		Sound Level	Air Consumption		Exhaust
	in	mm	ft lb	Nm	rpm	lb	kg	in	mm	in	mm	dB(A)	scfm	l/s	
SRW03S-25	1/4"	6	35	47	235	1.4	0.6	7.7	197	1.1	28	84	10	0.63	Rear
SRW03S-38	3/8"	10	35	47	235	1.4	0.6	7.7	197	1.1	28	85	10	0.63	Rear

General:

Air Inlet Size: 1/4" NPT • Recommended Hose Size: 3/8" (10 mm) • Performance rated @ 90 psig (6.2 bar) air pressure

Standard Equipment:

Parts List • Safety and Instruction Manual



SAFETY PRECAUTION: Read and follow all safety and operating instructions.
WARNING: Face & eye protection must be worn while operating power tools, per ANSI B186.1

ASSEMBLY

We're Making A Big Impact

Impact wrenches are the true workhorses of industrial power tools. These incredibly powerful tools make easy work of any job in a variety of applications. Before the creation of impact tools, workers had to manually strike a hammer against a hand wrench in order to loosen or tighten nuts or bolts. They could only manage a few blows per minute. But today's impact wrenches can exert more powerful blows, and some can produce over 2000 blows per minute. This is accomplished by using the energy of compressed air and converting the motor's torque into a rapid series of powerful rotary impacts.

Choice of Configuration

Sioux Tools, offers Industrial and Force Impact Wrenches and Impact Drivers in a wide variety of configurations to meet your specific applications. In order to select the correct impact tool for your job requirements, you must take into account several factors including fastener size and grade, required torque output, and accessibility. Choosing the right mix of features such as handle configuration, type of retainer, torque output, anvil length, and drive size will make operators more productive, with less risk of discomfort and/or injury.

Industrial Impact Tools

Built to a higher level of quality, Sioux Industrial Impact Wrenches and Impact Drivers are built a step above the standard. Manufactured from the highest quality materials, and utilizing the most advanced motor and clutch designs, these tools are constructed to hold up under continuous use in the toughest working environments.

Our extensive lineup of impact tools includes a wide selection of important features including:

- Ball & Cam or Twin Hammer impact mechanisms
- Inline, pistol grip, or D-handle configurations
- Pin, friction ring, quick change, or thru hole socket retainers
- Standard or extended anvils

In addition, Sioux offers a wide range of performance levels and characteristics to ensure a perfect match to your application. With drive sizes ranging from 1/4" (6 mm) to 1-1/2" (38 mm), and torque outputs up to 2500 ft lb (3390 Nm), finding the tool to meet your performance requirements will be simple.

Impact Wrench Principles of Operation

An impact wrench delivers a series of rotary blows to a fastener, producing torque.

The action of the torque creates clamp force in an assembly.

Interaction of the motor, clutch and drive-end determine the type of application an impact wrench can handle.

The advantages of impact wrenches are a high power-to-weight ratio, fast rundown, and no torque reaction to operator.

Class of Service

High production – automobile assembly plants, farm and construction equipment, etc.

Low production – large machinery assembly

Maintenance or repair work

Job Conditions

Hard pull-up – rigid joint

Soft pull-up – spring joint

Run-down – free running, or prevailing torque (lock nut, self threading screw)

Material

Metal-to-metal

Metal/gasket

Rubber or plastic

Assembly Method

General tightening – operator judgement

Turn-of-the-nut – permanent assemblies (steel erection and construction equipment)

Note: If it takes five seconds or longer to reach final tightness, a larger wrench should be used.

3/8" (10 MM) & 1/2" (13 MM) IMPACT WRENCHES



IW38TBP-3P



IW38HAP-3P



IW50HAP-4P

Performance:

Working Torque: 10 ft lb (13 Nm) – 450 ft lb (610 Nm)
 Drive Size: 3/8" (10 mm) – 1/2" (13 mm) square drive
 Bolt Capacity: 1/4" (6 mm) – 5/8" (16 mm)

Features:

Pistol Grip
 Steel Anvil Housing
 Suspension Bail



3/8" (10 mm) & 1/2" (13 mm) Impact Wrenches

Model Number	Drive Size		Bolt Cap Grade 5		Working Torque Range ¹		Maximum Torque		Blows Per Minute	Free Speed rpm	Weight		Length		Side To Center		Avg Air Consumption		Socket Retainer Style
	in	mm	in	mm	ft lb	Nm	ft lb	Nm			lb	kg	in	mm	in	mm	cfm	l/s	
Pistol Grip																			
IW50HAP-4F	1/2	13	5/8	16	100-450	135-610	550	745	1140	7000	4.3	1.9	7.6	192	1.3	33	4	2	Ring
IW50HAP-4P	1/2	13	5/8	16	100-450	135-610	550	745	1140	7000	4.3	1.9	7.6	192	1.3	33	4	2	Pin
IW38TBP-3P	3/8	10	1/4	6	10-70	13-95	70	95	2000	8000	2.1	1.0	6.3	160	0.9	22	2	1	Pin
IW38HAP-3F	3/8	10	3/8	10	60-200	80-270	250	340	1380	10,000	3.3	1.5	6.7	170	1.1	28	2	1	Ring
IW38HAP-3P	3/8	10	3/8	10	60-200	80-270	250	340	1380	10,000	3.3	1.5	6.7	170	1.1	28	2	1	Pin
IW38HAP-4F	1/2	13	3/8	10	60-200	80-270	250	340	1380	10,000	3.3	1.5	6.7	170	1.1	28	2	1	Ring
IW38HAP-4P	1/2	13	3/8	10	60-200	80-270	250	340	1380	10,000	3.3	1.5	6.7	170	1.1	28	2	1	Pin

¹ Maximum working torque determined by 5 second rundown on appropriate Skidmore-Wilhelm Torque-Tension Tester.

General:

Air Inlet Size: 1/4" NPT • Recommended Hose Size: 3/8" (10 mm) • Performance rated @ 90 psig (6.2 bar) air pressure

Standard Equipment:

Parts List • Safety and Instruction Manual • Suspension Bail

Accessories:

Impact Wrench Accessories, see pages 38 – 39

3/8" (10 MM) IMPACT WRENCH



3/8" Pinned Anvil



3/8" Friction Ring Anvil



IW375AP-3P

Key Features:

High power to weight ratio
 High impact rate of 5,000 blows per minute
 Working torque range up to 95 ft/lbs
 Extended life through bearing design
 Smooth Impacting that creates minimal torque reaction
 Includes rubber boot for hammer case

Applications:

Wood Screws
 Self-tapping screws
 Lag bolts
 High prevailing torque applications



Impacts

Model Number	Drive Size		Working Torque Range ¹		Maximum Torque		Blows Per Minute	Free Speed rpm	Weight		Length		Side To Center		Socket Retainer Style
	in	mm	ft lb	Nm	ft lb	Nm			lb	kg	in	mm	in	mm	
Pistol Grip Impact Wrench															
IW375AP-3P	3/8	10	10-95	13-130	100	135	5000	4000	2.5	1.1	8.5	216	085	21	Pin
IW375AP-3F	3/8	10	10-95	13-130	100	135	5000	4000	2.5	1.1	8.5	216	085	21	Ring

¹ Maximum working torque determined by 5 second rundown on appropriate Skidmore-Wilhelm Torque-Tension Tester.

General:

Air Inlet Size: 1/4" NPT • Recommended Hose Size: 3/8" (10 mm) • Performance rated @ 90 psig (6.2 bar) air pressure

Standard Equipment:

Parts List • Safety and Instruction Manual

Accessories:

Impact Wrench Accessories, see pages 38 – 39



SAFETY PRECAUTION: Read and follow all safety and operating instructions.
WARNING: Face & eye protection must be worn while operating power tools, per ANSI B186.1

3/4" (19 MM), 1" (25 MM), 1-1/2" (38 MM) IMPACT WRENCHES



IW75BP-6H



IW100HAI-8H

Performance:

Working Torque: 800 ft lb (1085 Nm) – 2500 ft lb (3390 Nm)
 Drive Size: 3/4" (19 mm) – 1-1/2" (38 mm)
 Bolt Capacity: 3/4" (19 mm) – 2" (50 mm)

Features:

Pistol Grip and D-Handle
 Inside and Outside Trigger (D-Handle Models)
 Steel Anvil Housing

3/4" (19 mm), 1" (25 mm), 1-1/2" (38 mm) Impact Wrenches



Model Number	Drive Size		Bolt Cap Grade 5		Working Torque Range ¹		Maximum Torque		Blows Per Minute	Free Speed	Weight		Length		Side To Center		Avg Air Consumption		Socket Retainer Style
	in	mm	in	mm	ft lb	Nm	ft lb	Nm			rpm	lb	kg	in	mm	in	mm	cfm	
Pistol Grip																			
IW75BP-6H	3/4	19	3/4	19	800	1085	1000	1356	1000	5700	11.6	5.3	7.6	193	1.75	45	15	7	Hole
IW75BP-8H	1	25	3/4	19	825	1119	1100	1492	1000	5700	11.7	5.3	7.6	193	1.75	45	15	7	Hole
D-Handle – Inside Trigger																			
IW150HAI-5S	#5 Spline		2	50	2500	3390	3000	4070	650	3750	33.0	15.0	14.5	368	2.5	65	60	28	Hole
IW150HAI-12H	1-1/2	38	2	50	2500	3390	3000	4070	650	3750	33.1	15.0	14.5	368	2.5	65	60	28	Hole
IW100HAI-8H	1	25	1-3/8	35	1600	2170	2000	2710	850	5000	22.0	10.0	12.4	315	2	51	38	18	Hole
IW100HAI-8H6	1	25	1-3/8	35	1600	2170	2000	2710	850	5000	26.2	11.8	18.4	467	2	51	38	18	Hole
IW100HAI-5S	#5 Spline		1-3/8	35	1600	2170	2000	2710	850	5000	22.0	10.0	12.4	315	2	51	38	18	Hole
IW100HAI-5S6	#5 Spline		1-3/8	35	1600	2170	2000	2710	850	5000	26.2	11.8	18.4	467	2	51	38	18	Hole
D-Handle – Outside Trigger																			
IW150HAO-5S	#5 Spline		2	50	2500	3390	3000	4070	650	3750	33.0	15.0	14.5	368	2.5	65	60	28	Hole
IW150HAO-12H	1-1/2	38	2	50	2500	3390	3000	4070	650	3750	33.0	15.0	14.5	368	2.5	65	60	28	Hole
IW100HAO-8H	1	25	1-3/8	35	1600	2170	2000	2710	850	5000	22.0	10.0	12.4	315	2	51	38	18	Hole
IW100HAO-8H6	1	25	1-3/8	35	1600	2170	2000	2710	850	5000	26.2	11.8	18.4	467	2	51	38	18	Hole
IW100HAO-5S	#5 Spline		1-3/8	35	1600	2170	2000	2710	850	5000	22.0	10.0	12.4	315	2	51	38	18	Hole
IW100HAO-5S6	#5 Spline		1-3/8	35	1600	2170	2000	2710	850	5000	26.2	11.8	18.4	467	2	51	38	18	Hole

¹ Maximum working torque determined by 5 second rundown on appropriate Skidmore-Wilhelm Torque-Tension Tester.

General:

Air Inlet Size: 3/8" NPT (IW75 series) • Air Inlet Size: 1/2" NPT (IW100 & IW150 series) • Recommended Hose Size: 1/2" (30 mm) • Performance rated @ 90 psig (6.2 bar) air pressure

Standard Equipment:

Parts List • Safety and Instruction Manual • Suspension Bail (IW75 models) • Support handle (D-Handle models)

Accessories:

Impact Wrench Accessories, see pages 38 – 39



SAFETY PRECAUTION: Read and follow all safety and operating instructions.
WARNING: Face & eye protection must be worn while operating power tools, per ANSI B186.1

IMPACT DRIVERS



IW38TBP-2Q



IW38HAP-7Q

Performance:

Torque: 10 ft lb (13 Nm) – 200 ft lb (270 Nm)
 Drive Size: 1/4" (6 mm) hex – 7/16" (11 mm) hex
 Bolt Capacity: 1/4" (6 mm) – 3/8" (10 mm)

Features:

Pistol Grip
 Steel Anvil Housing
 Suspension Bail
 Quick Change Bit Retainer



Impact Drivers

Model Number	Drive Size		Bolt Cap Grade 5		Working Torque Range ¹		Maximum Torque		Blows Per Minute	Free Speed	Weight		Length		Side To Center		Avg Air Consumption		Socket Retainer Style
	in	mm	in	mm	ft lb	Nm	ft lb	Nm			lb	kg	in	mm	in	mm	cfm	l/s	
Pistol Grip – Trigger Start																			
IW38HAP-7Q	7/16	11	3/8	10	60-200	80-270	250	340	1380	10,000	3.3	1.5	6.7	170	1.1	28	2	1	QC
IW38TBP-2Q	1/4	6	1/4	6	10-70	13-95	70	95	2000	8000	2.1	1.0	6.3	160	0.9	22	2	1	QC

¹ Maximum working torque determined by 5 second rundown on appropriate Skidmore-Wilhelm Torque-Tension Tester

General:

Air Inlet Size: 1/4" NPT • Recommended Hose Size: 3/8" (10 mm) • Performance rated @ 90 psig (6.2 bar) air pressure

Standard Equipment:

Parts List • Safety and Instruction Manual • Suspension Bail

Accessories:

Impact Driver Accessories, see pages 38 – 39

1/4" (6 MM) IMPACT DRIVER



1/4" Quick Change



ID375AP-2Q

Key Features:

High power to weight ratio
 High impact rate of 5,000 blows per minute
 Working torque range up to 95 ft/lbs
 Extended life through bearing design
 Smooth Impacting that creates minimal torque reaction
 includes rubber boot for hammer case

Applications:

Wood Screws
 Self-tapping screws
 Lag bolts
 High prevailing torque applications



Impacts

Model Number	Drive Size		Working Torque Range ¹		Maximum Torque		Blows Per Minute	Free Speed	Weight		Length		Side To Center		Socket Retainer Style
	in	mm	ft lb	Nm	ft lb	Nm			lb	kg	in	mm	in	mm	
Pistol Grip Impact Driver															
ID375AP-2Q	1/4	6	10-55	13-75	60	80	5000	4000	2.5	1.1	8.5	216	085	21	Quick Change

¹ Maximum working torque determined by 5 second rundown on appropriate Skidmore-Wilhelm Torque-Tension Tester.

General:

Air Inlet Size: 1/4" NPT • Recommended Hose Size: 3/8" (10 mm) • Performance rated @ 90 psig (6.2 bar) air pressure

Standard Equipment:

Parts List • Safety and Instruction Manual

Accessories:

Impact Wrench Accessories, see pages 38 – 39



SAFETY PRECAUTION: Read and follow all safety and operating instructions.
WARNING: Face & eye protection must be worn while operating power tools, per ANSI B186.1

TM SERIES TORQUE MULTIPLIERS



TM50AP-4515K

- Features:
- Lightweight Titanium Gear Case – Offers 30% weight savings than standard steel gear casing
- Two Speed Gear Shift – More versatility and higher torque range
- High Quality Gears – For longer operating life expectancy between repairs
- Ergo Over Molded Grip – more comfort on the hand
- Integrated swivel joint between drive and gear case – Insures reaction-free operation over the entire bolting cycle
- Fine Pressure Control for torque pre-selection – Ultimate control
- No lateral or impact forces transmitted from tool to user – No sparks from the bolts and less vibration on the user than impact wrenches



TM Series Torque Multipliers

Model Number	Drive Size		Torque				Speed		Weight		Noise Level
			Gear 1		Gear 2		Gear 1	Gear 2			
	in	mm	ft lb	Nm	ft lb	Nm	rpm	rpm	lb	kg	
TM50AP-0775	3/4	19	45-188	61-255	125-580	169-786	69	12	10.7	4.9	84
TM50AP-0775K ¹	3/4	19	45-188	61-255	125-580	169-786	69	12	10.7	4.9	84
TM50AP-1075	1	25	59-295	80-400	220-900	298-1220	30	8	13.0	5.9	84
TM50AP-1075K ¹	1	25	59-295	80-400	220-900	298-1220	30	8	13.0	5.9	84
TM50AP-15100	1	25	40-370	54-502	150-1300	203-1763	25	7	15.6	7.1	84
TM50AP-15100K ¹	1	25	40-370	54-502	150-1300	203-1763	25	7	15.6	7.1	84
TM50AP-25100	1	25	110-600	149-813	340-2100	461-2847	9.4	2.6	22.4	10.1	84
TM50AP-25100K ¹	1	25	110-600	149-813	340-2100	461-2847	9.4	2.6	22.4	10.1	84
TM50AP-45150	1-1/2	38	160-1100	217-1491	500-3500	678-4745	6	1.7	23.1	10.5	84
TM50AP-45150K ¹	1-1/2	38	160-1100	217-1491	500-3500	678-4745	6	1.7	23.1	10.5	84
TM50AP-60150	1-1/2	38	220-1600	298-2169	650-5000	881-6779	5.3	1.5	36.3	16.5	84
TM50AP-60150K ¹	1-1/2	38	220-1600	298-2169	650-5000	881-6779	5.3	1.5	36.3	16.5	84

¹ Includes FRL Kit. If you do not own a filter regulator lubricator to operate your TM Series tools, we highly recommend that you purchase your tool with the FRL Kit included.
General: Air Inlet Size: 1/4" NPT (Please use high flow fittings only) • Recommended Hose Size: 3/8" (10 mm) • Performance rated @ various air pressures as specified in operations manual
Standard Equipment: Parts List, Safety and Instruction Manual • Reaction arm • Metal carrying case
Accessories: Torque Multiplier Accessories, see pages 36 – 39

Applications:
Petroleum Processing

- Heat Exchanger
- Expander
- Preventer
- Converter

Blast Furnace Plants, Steel Works, Hot Rolling

- Pipe Construction, Flanges
- Pipe Welding Machine
- Blast Furnace Tongues

Non-Ferrous Metal Works

- Pipe Construction, Flanges
- Feed Pumps

Steel Drawing Plants and Cold Rolling Mills

- Rolling Mills
- Pipe Welding Tracks

Steel and Lightweight Metal Construction

- Bridge Construction
- Hall Construction
- Steel Girders
- Temporary Bridges
- Tower Crane
- Ship Deck Crane

Steelwork, Rolling Mill Equipment, Mining and Large Equipment

- Coking Plant
- Shovel Dozer
- Heading and Cutting Machine for Tunnels
- Crawler Mounted Excavator
- Hydraulic Excavator
- Crawler Type Undercarriages
- Crawler Mounted Crane
- Conveyor Systems
- Drawn up Cranes
- Crushers

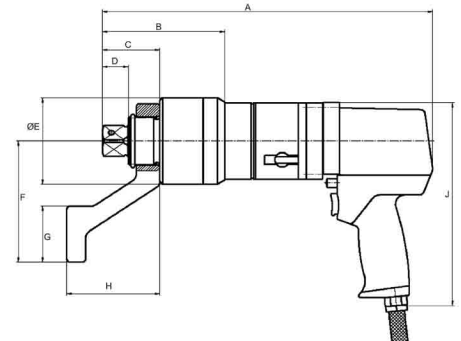

Torque Multiplier Dimensions

Model Number	A		B		C		D		E		F		G		H		J	
	in	mm	in	mm	in	mm	in	mm	in	mm	in	mm	in	mm	in	mm	in	mm
TM50AP-0775	13.46	341	4.98	126	2.26	57	0.87	22	3.23	82	4.33	110	1.97	50	3.15	80	8.66	220
TM50AP-1075	13.5	342	5.12	130	2.44	62	1.06	105	3.23	82	5.12	130	2.36	60	3.94	100	8.66	220
TM50AP-15100	13.98	355	5.18	132	2.42	61	1.06	105	3.66	93	5.12	130	2.36	60	3.94	100	8.66	220
TM50AP-25100	15.55	395	5.91	150	2.87	73	1.06	105	3.86	98	6.69	170	2.36	60	3.94	100	8.66	220
TM50AP-45150	16.54	420	7.4	188	6.38	162	1.57	40	3.90	99	6.69	170	2.36	60	5.24	133	8.66	220
TM50AP-60150	17.9	455	10.37	263	3.86	98	1.57	40	4.72	120	7.48	190	3.15	80	5.91	150	8.66	220



SAFETY PRECAUTION: Read and follow all safety and operating instructions.
WARNING: Face & eye protection must be worn while operating power tools, per ANSI B186.1

TM SERIES TORQUE MULTIPLIERS ACCESSORIES

Reaction Arms:

Standard reaction arms are included with each tool. Long or deep reaction arms are used when standard arms fall short in length. Welding rings are used to make custom reaction arms by welding the extensions to the spline ring.

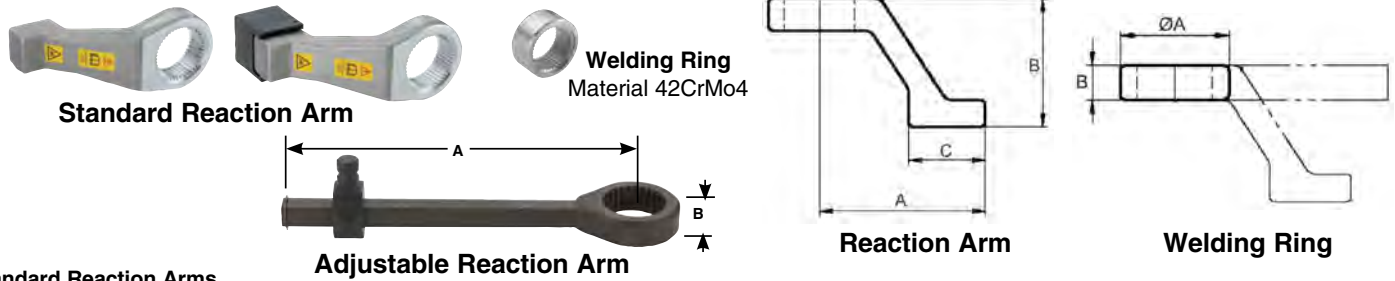

Standard Reaction Arms

Model Number	Tools Used On	A		B		C	
		in	mm	in	mm	in	mm
RARM-1	TM50AP-0775, RATM50-07	4.33	110	3.15	80	1.97	50
RARM-2	TM50AP-1075, RATM50-10 TM50AP-15100, RATM50-15	5.12	130	3.94	100	2.36	60
RARM-3	TM50AP-25100, RATM50-25	6.69	170	5.11	129	2.36	60
RARM-4	TM50AP-45150, RATM50-45	6.69	170	5.24	150	2.36	60
RARM-5	TM50AP-60150, RATM50-60	7.48	190	5.91	150	3.15	80

Welding Rings

WRARM-1	TM50AP-0775, RATM50-07, TM50AP-1075 RATM50-10, TM50AP-15100, RATM50-15	3.07	78	0.98	25	-	-
WRARM-2	TM50AP-25100, RATM50-25	3.86	98	1.3	33	-	-
WRARM-3	TM50AP-45150, RATM50-45 TM50AP-60150, RATM50-60	4.33	110	1.97	50	-	-

Long or Deep Reaction Arms

LRARM-1	TM50AP-0775, RATM50-07	4.33	110	4.72	120	1.97	50
LRARM-2	TM50AP-1075, RATM50-10 TM50AP-15100, RATM50-15	5.12	130	5.52	140	2.36	60
LRARM-3	TM50AP-25100, RATM50-25	6.69	170	5.91	150	2.36	60
LRARM-4	TM50AP-45150, RATM50-45	6.69	170	7.1	180	2.36	60
LRARM-5	TM50AP-60150, RATM50-60	7.48	190	7.88	200	3.15	80

Adjustable Reaction Arms

ARARM-1	TM50AP-0775	11.80	300	1.00	25	N/A	N/A
ARARM-2	TM50AP-1075 and TM50AP-15100	11.80	300	1.00	25	N/A	N/A
ARARM-3	TM50AP-25100 and TM50AP-45150	14.20	360	1.30	33	N/A	N/A

Steel Reaction Arms are available. To order put the suffix "S" after the model number (example: RARM-1S).

Filter-Regulator-Lubricator Kit

Model: FRLK1660

Weight: 13 lb

Includes 10 ft 3/8" Hose, Stand, Filter, Regulator, Lubricator, Nuts and Bolts for mounting, and Pressure Gauge.

The FRLK1660 is used to regulate the air pressure and properly lubricate the air motor for ultimate life between service. The chart is an example of what's included in each tool's operation's manual. Air pressure regulates and controls torque output. All TM Series tools must be used with an FRL and it's strongly advised not to exceed the maximum amount of air pressure.



TM SERIES TORQUE MULTIPLIERS ACCESSORIES

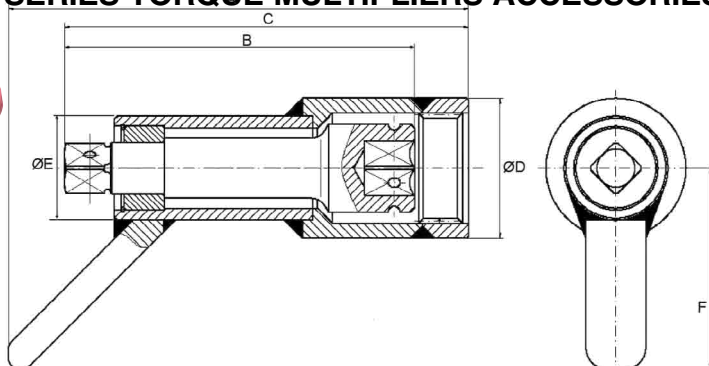

Wheel Extensions

Model Number	Drive Size		A		B		C		D		E		F	
	in	mm	in	mm	in	mm	in	mm	in	mm	in	mm	in	mm
TMEXT-07	3/4	19	9.38	238	6.89	175	8.27	210	2.76	70	1.89	48	3.94	100
TMEXT-07-8	3/4	19	10.36	263	7.87	200	9.26	235	2.76	70	1.89	48	3.94	100
TMEXT-07-10	3/4	19	12.33	313	9.84	250	11.23	285	2.76	70	1.89	48	3.94	100
TMEXT-07-13	3/4	19	15.48	393	13	330	14.83	365	2.76	70	1.89	48	3.94	100
TMEXT-10	1	25	9.5	241	6.89	175	8.35	212	3.07	78	2.05	52	4.33	110
TMEXT-10-8	1	25	10.48	266	7.87	200	13.28	237	3.07	78	2.05	52	4.33	110
TMEXT-10-10	1	25	12.45	316	9.84	250	11.31	287	3.07	78	2.05	52	4.33	110
TMEXT-10-13	1	25	15.6	396	13	330	14.46	367	3.07	78	2.05	52	4.33	110
TMEXT-25	1	25	10.05	255	6.9	175	8.51	216	3.55	90	2.36	60	5.32	135
TMEXT-25-8	1	25	11.03	280	7.88	200	9.5	241	3.55	90	2.36	60	5.32	135
TMEXT-25-10	1	25	13	330	9.85	250	11.47	291	3.55	90	2.36	60	5.32	135
TMEXT-25-13	1	25	16.15	410	13	330	14.62	371	3.55	90	2.36	60	5.32	135

Grab Wheel

The Grab Wheel option offers advantages of reducing labor time and increasing worker safety. In most plants, the operation people are the only ones who manage the valves, which can take 5 to 8 hours to open and close utilizing multiple personnel. With the new Sioux Plarad and Grab Wheel system, one person can do it in less than 30 minutes including set-up. The Plarad weighs about 13 pounds and the grab wheel attachment is about 25 pounds. Once mounted on the spokes of the valve wheel, the operator doesn't have to hold the load. The Grab Wheel comes equipped with 4" pins that hold the spokes of the valve wheel for ease of set-up and versatility.



STX22-02-GW

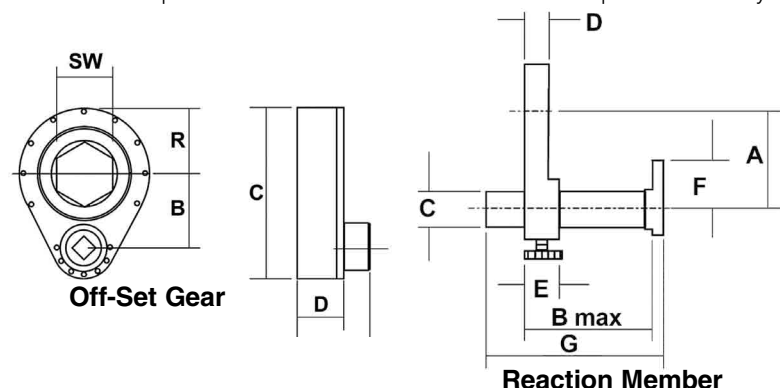

Off-Set Gear

Reaction Member



Off-Set Gears

Off-Set Gear Measurements

Model Number	Max Torque		SW		A		B		C		D		R	
	ft lb	Nm	in	mm	in	mm	in	mm	in	mm	in	mm	in	mm
STX22-02-TL	1623	2200	2.56	65	4.1	104	3.2	81	7.49	190	2.6	66	2.52	64
STX36-02-TL	2655	3600	3.94	100	4.18	106	4.39	112	10.02	255	2.68	67	3.82	97

Output torque of STX-22-02-TL = Torque from Torque Multiplier x 1.6

Output torque of STX-36-02-TL = Torque from Torque Multiplier x 2.5

Reaction Member Measurements

Model Number	A		B		C		D		E		F		G		Weight	
	in	mm	in	mm	in	mm	in	mm	in	mm	in	mm	in	mm	lb	kg
STX22-R	3.27	83	5.52	140	0.79	20	0.79	20	1.18	30	1.97	50	5.91	150	2.6	5.7
STX36-R	3.27	83	5.52	140	1.18	30	0.79	20	1.18	30	1.97	50	5.91	150	3.0	6.6



SAFETY PRECAUTION: Read and follow all safety and operating instructions.
WARNING: Face & eye protection must be worn while operating power tools, per ANSI B186.1

STX22-02-TL

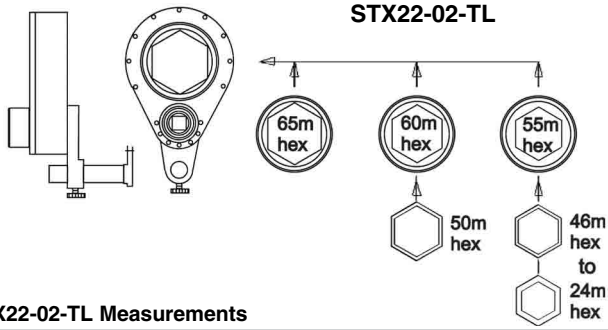

STX22-02-TL Measurements

Model Number	Description
Off-set Gear	Hex Size
STX22-02-TL	65
STX22-02-60	60
STX22-02-55	55
Standard Inserts	Inserts / Standard Inserts
STX22-H55-24	55 / 24
STX22-H55-30	55 / 30
STX22-H55-32	55 / 32
STX22-H55-36	55 / 36
STX22-H55-41	55 / 41
STX22-H55-46	55 / 46
STX22-H60-50	60 / 50

Grab Wheel Pins

Part No GWP-3 (3" Pins)

Part No GWP-4 (4" Pins)

For use on STX22-02-GW

Sold Separately



Socket Retaining Pins with "O" Rings



34911B & 14318

Retaining Pin	"O" Ring	For Use On
34911B	14318	3/4" Drive Sockets 6620-6638
34911B	14319	Adaptors 2564, 2565, 2566
34665	14319	Adaptor 2568, All 1" Drive Sockets

TMSRC Socket Retaining Clips



TMSRC-100

Model Number	Socket Size
TMSRC-75	3/4" Socket
TMSRC-100	1" Socket
TMSRC-150	1 1/2" Socket

STX36-02-TL

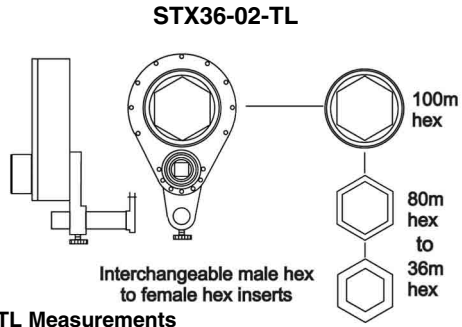

STX36-02-TL Measurements

Model Number	Description
Off-set Gear	Hex Size
STX36-02-TL	100
Standard Inserts	Inserts / Standard Inserts
STX36-100-80	100 / 80
STX36-100-75	100 / 75
STX36-100-70	100 / 70
STX36-100-65	100 / 65
STX36-100-60	100 / 60
STX36-100-55	100 / 55
STX36-100-50	100 / 50
STX36-100-46	100 / 46
STX36-100-36	100 / 36

Clutch Springs



41284

Part Number	Color	Torque Range	
		in lb	Nm
SSD, SD9A, 2 Series Adjustable Clutch			
41284	Green	<25	<2.8
21427	N/A	>25	>2.8
1 Series Adjustable Clutch			
66048	Silver	30-50	3.4-5.7
66049	Blue	15-35	1.7-4.0
66050	Green	2.0-20	0.22-2.3
2 Series Torque Control Clutch			
65048	Silver	60-280	6.8-32
65049	Blue	36-180	4.1-20
65050	Green	30-120	3.4-14

Comfort Grips



66193



67806

Part Number	For Use On
66124	1 Series inline (except 2800 rpm)
66193	1 Series inline (2800 rpm)
68340	1 Series pistol grip
67806	SD9A Series



SAFETY PRECAUTION: Read and follow all safety and operating instructions.
WARNING: Face & eye protection must be worn while operating power tools, per ANSI B186.1

Insert Bit Adapters

Square drive to 5/16" female hex



2534

Part Number	Drive Size
2534	3/8"
2585	1/2"

Quick Change Chuck

Adapts male square drive to female hex quick change



2520

Part Number	Drive Size		Length
	Input (Square Drive)	Output (Hex)	
2530	3/8"	1/4"	1-13/16"
2520	1/2"	7/16"	2 1/4"

Magnetic Bit Holder

Part No: 2525

Accepts 1/4" Hex Insert Bits

Bushing Part No 2497 used with 2525



Phillips Head Insert Bits



Part Number	Bit Size	Length		Point Size
	in	in	mm	
2547	1/4"	1"	25	1
2548	1/4"	1"	25	2
2549	1/4"	1"	25	3
2587	5/16"	1-1/4"	32	2

Socket Head Insert Bits



Part Number	Length		Hex Size
	in	mm	
2950	1"	25	3/32"
2535B	1"	25	1/8"
2536	1-5/16"	33	5/32"
2567	1-5/16"	33	3/16"



SAFETY PRECAUTION: Read and follow all safety and operating instructions.
WARNING: Face & eye protection must be worn while operating power tools, per ANSI B186.1

ABRASIVE



Index

Grinders. 42 – 48

Abrasive Accessories. 49

ABRASIVE

Make Easy Work Out Of A Daily Grind

As manufacturing materials advance, so do the requirements for the tools to work on them. This means new speeds and attachments to handle the demands of increased precision and waste reduction.

The right tool for the job

When selecting a grinder and accessories for your application, be sure to choose one with enough horsepower to drive the abrasive wheel you are using. This will allow the grinder's speed to work for you. When the operator bears down on an under-powered tool, it slows the rpm output and reduces overall efficiency.



Industrial Grinders

Sioux has a great selection of inline and right angle grinders with collet sizes from 1/4" to 1/2" & 3 mm – 8 mm for a variety of applications. Speeds range up to 25,000 rpm to get the job done quickly and efficiently. Some models offer a choice of throttle control that is most convenient and comfortable for the operator. We also have extended models that fit into tight, hard to reach places.

Abrasive Grinders Principles of Operation

When wheels, pads or other accessories are attached to the spindle, the tool can be used to remove metal or composites in a variety of ways.

Abrasive Safety

Grinders can cause flying particles. Proper eye protection must be worn at all times by tools user and bystanders.

Under improper use and wear, Air grinders can cause serious injury and death. The following instructions are important and should be followed explicitly but cannot cover all contingencies. Good judgment is always required.

Using a grinder without a guard can cause injury. The grinder is to be operated with an appropriate guard at all times when a grinding wheel is used. Replace a damaged guard. The guard is to be the proper one for the wheel being used.

Damaged grinding wheels can explode. Check the wheel for damage before mounting, such as chips and cracks. Handle wheels carefully to avoid dropping or bumping. Protect wheels from extremes of temperature and humidity. Check wheels immediately after any unusual occurrence that may damage wheels.



Over speeding wheels can explode. Check the speed rating of the accessory or the speed printed on the wheel. This speed must be greater than the name plate speed of the grinder/sander and the actual speed of the grinder/sander as measured with a tachometer.

Unsecured work can move violently when grinding. Secure work; use clamps or vise to hold work.

Grinders may coast for a short time after the trigger is released. Be sure tool has come to a complete stop before setting it aside.

Grinding wheels that malfunction or spin off can cause injury. Be certain that all wheel, flanges, nuts and related equipment are in good shape, the proper ones for the type and size of wheel being used, and are securely fastened.

Exploding wheels can cause injury or death. If the normal sound of the grinder changes, or if it vibrates excessively, shut it off immediately, remove the wheel, and check speed with tachometer.

Unexpected starts can cause injury. Be sure actuator is off before hooking up air.

Breathing grinding dust can cause injury. Do not breathe grinding dust. Use approved mask.

Explosions and fire can cause injury. Only grind metals if the area is free of combustible or explosive materials or vapors.

Contact with rotating grinding wheels can cause injury. Keep hands and other body parts away from grinding wheels and sanding pads and disks to prevent cutting or pinching. Wear protective clothing and gloves to protect hands.

Tools starting unexpectedly can cause injury. Always remove tool from air supply and activate trigger to bleed air line before making any adjustments, changing accessories, or doing any maintenance or service on the tool.

Flying grinding wheels or accessories can cause injury. Tighten collet securely. Match wheel or accessory shaft diameter to chuck or collet.

Exploding or flying parts can cause injury. Do not use cut off wheels or router bits with die grinders.

HIGH TORQUE DIE GRINDERS

Double Ball Bearing Support On Output Spindle

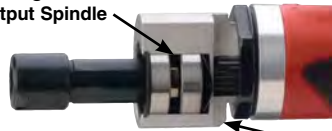

Offset Gear Box For Increased Torque



SDG10SHT08



SDG10SHT12



High Torque Die Grinders

Model Number	Free Speed	Weight		Length		Sound Level	Air Consumption		Collet Size	Exhaust
	rpm	lb	kg	in	mm	dB(A)	cfm	l/s		
1 hp (0.75 kw) – Lever Throttle – High Torque										
SDG10SHT08	8,000	2.0	0.90	9.5	240	85.6	35	16.5	1/4"	Rear
SDG10SHT08M6	8,000	2.0	0.90	9.5	240	85.6	35	16.5	6 mm	Rear
SDG10SHT12	12,000	2.0	0.90	9.5	240	84.0	35	16.5	1/4"	Rear
SDG10SHT12M6	12,000	2.0	0.90	9.5	240	84.0	35	16.5	6 mm	Rear

General:

Air Inlet Size: 1/4" NPT • Recommended Hose Size: 3/8" (10 mm) • Performance rated @ 90 psig (6.2 bar) air pressure

Standard Equipment:

Parts List • Safety and Instruction Manual • Collet & Wrenches

Accessories:

Grinder Accessories, see pages 49

STRAIGHT DIE GRINDERS



RT1985

Performance:

Power: 1.5 hp (1.1 kw)
 Speed: 20,000 rpm
 Collet Size: 1/4" – 1/2" & 6 mm

Features:

Twist Throttle
 Side Exhaust
 Built-in Speed Control



Straight Die Grinders

Model Number	Free Speed	Weight		Length		Sound Level	Air Consumption		Collet Size	Exhaust
	rpm	lb	kg	in	mm	dB(A)	cfm	l/s		
1.5 hp (1.1 kw) – Twist Throttle										
RT1985 ¹	20,000	4.3	2.0	7.6	193	84	38	18	1/4"	Side
1985-1/2	20,000	4.3	2.0	7.6	193	84	38	18	1/2"	Side
1985A	20,000	4.3	2.0	7.6	193	84	38	18	3/8"	Side

¹Not CE Certified

General:

Air Inlet Size: 1/4" NPT • Recommended Hose Size: 3/8" (10 mm) • Performance rated @ 90 psig (6.2 bar) air pressure

Standard Equipment:

Parts List • Safety and Instruction Manual • Collet & Wrenches • Collet Guard (1DS series)

Accessories:

Grinder Accessories, see pages 49



SAFETY PRECAUTION: Read and follow all safety and operating instructions.
WARNING: Face & eye protection must be worn while operating power tools, per ANSI B186.1

STRAIGHT DIE GRINDERS



SDG03S25



SDG05S23



SDG7S25F



SDG10S25F

Performance:

Power: 0.3 hp (0.2 kw) – 1 hp (.75 kw)
 Speed: 12,000 rpm – 25,000 rpm
 Collet Size: 1/4" & 6 mm

Features:

Lockoff Lever
 Front or Rear Exhaust
 Built-in Speed Control

Straight Die Grinders



Model Number	Free Speed	Weight		Length		Sound Level	Air Consumption		Collet Size	Exhaust
	rpm	lb	kg	in	mm	dB(A)	cfm	l/s		
0.3 hp (0.22 kw) – Lever Throttle – 200 Series Collet										
SDG03S25	25,000	1.0	0.45	6.25	160	83.3	11	5.2	1/4"	Rear
SDG03S25M6	25,000	1.0	0.45	6.25	160	83.3	11	5.2	6 mm	Rear
0.3 hp (.22 kw) – Lever Throttle – 300 Series Collet										
SDG03S25S	25,000	1.0	0.45	6.25	160	83.3	11	5.2	1/4"	Rear
SDG03S25M6S	25,000	1.0	0.45	6.25	160	83.3	11	5.2	6mm	Rear
0.5 hp (0.37 kw) – Lever Throttle – 200 Series Collet										
SDG05S18	18,000	1.2	0.54	7.0	180	87.4	23	10.9	1/4"	Rear
SDG05S18M6	18,000	1.2	0.54	7.0	180	87.4	23	10.9	6 mm	Rear
SDG05S23	23,000	1.2	0.54	7.0	180	85.1	23	10.9	1/4"	Rear
SDG05S23M6	23,000	1.2	0.54	7.0	180	85.1	23	10.9	6 mm	Rear
0.5 hp (.37 kw) – Lever Throttle – 300 Series Collet										
SDG05S18S	18,000	1.2	0.54	7.0	180	87.4	23	10.9	1/4"	Rear
SDG05S18M6S	18,000	1.2	0.54	7.0	180	87.4	23	10.9	6mm	Rear
SDG05S23S	23,000	1.2	0.54	7.0	180	85.1	23	10.9	1/4"	Rear
SDG05S23M6S	23,000	1.2	0.54	7.0	180	85.1	23	10.9	6mm	Rear
0.7 hp (0.52 kw) – Lever Throttle – 200 Series Collet										
SDG7S18F	18,000	1.2	0.6	6.0	150	82	25	12	1/4"	Front
SDG7S18M6F	18,000	1.2	0.6	6.0	150	82	25	12	6 mm	Front
SDG7S25F	25,000	1.2	0.6	6.0	150	82	25	12	1/4"	Front
SDG7S25M6F	25,000	1.2	0.6	6.0	150	82	25	12	6 mm	Front
1 hp (0.75 kw) – Lever Throttle – 200 Series Collet										
SDG10S12F	12,000	1.7	0.8	7.5	190	78	30	14	1/4"	Front
SDG10S12M6F	12,000	1.7	0.8	7.5	190	78	30	14	6 mm	Front
SDG10S12R	12,000	1.7	0.8	7.5	190	78	30	14	1/4"	Rear
SDG10S12M6R	12,000	1.7	0.8	7.5	190	78	30	14	6 mm	Rear
SDG10S18F	18,000	1.7	0.8	7.5	190	78	30	14	1/4"	Front
SDG10S18M6F	18,000	1.7	0.8	7.5	190	78	30	14	6 mm	Front
SDG10S18R	18,000	1.7	0.8	7.5	190	78	30	14	1/4"	Rear
SDG10S18M6R	18,000	1.7	0.8	7.5	190	78	30	14	6 mm	Rear
SDG10S25F	25,000	1.7	0.8	7.5	190	78	30	14	1/4"	Front
SDG10S25M6F	25,000	1.7	0.8	7.5	190	78	30	14	6 mm	Front
SDG10S25R	25,000	1.7	0.8	7.5	190	78	30	14	1/4"	Rear
SDG10S25M6R	25,000	1.7	0.8	7.5	190	78	30	14	6 mm	Rear

General:

Air Inlet Size: 1/4" NPT • Recommended Hose Size: 3/8" (10 mm) • Performance rated @ 90 psig (6.2 bar) air pressure

Standard Equipment:

Parts List • Safety and Instruction Manual • Collet & Wrenches • Collet Guard (1DS series)

Accessories:

Grinder Accessories, see pages 49



SAFETY PRECAUTION: Read and follow all safety and operating instructions.
WARNING: Face & eye protection must be worn while operating power tools, per ANSI B186.1

EXTENDED DIE GRINDERS



SXG05S23



STXG10S23

Performance:

Power: 0.5 hp (0.37 kw) – 1 hp (.75 kw)
 Speed: 12,000 rpm – 23,000 rpm
 Collet Size: 1/4" (6 mm)

Features:

Heavy duty double tapered collet
 Ergonomic comfort grip
 Teasing throttle for maximum control
 Lever throttle with lock-off
 Ball bearing construction
 Adjustable speed control



Extended Die Grinders

Model Number	Free Speed	Weight		Length		Sound Level	Air Consumption		Collet Size	Exhaust
	rpm	lb	kg	in	mm	dB(A)	cfm	l/s		
0.5 hp (0.37 kw) – Lever Throttle – Extended – 200 Series Collet										
SXG05S18	18,000	2.1	0.95	11	280	86.7	23	10.9	1/4"	Rear
SXG05S18M6	18,000	2.1	0.95	11	280	86.7	23	10.9	6 mm	Rear
SXG05S23	23,000	2.1	0.95	11	280	85.9	23	10.9	1/4"	Rear
SXG05S23M6	23,000	2.1	0.95	11	280	85.9	23	10.9	6 mm	Rear
0.5 hp (.37 kw) – Extended Die Grinder Lever Throttle – 300 Series Collet										
SXG05S18S	18,000	2.1	0.95	11.0	280	86.7	23	10.9	1/4"	Rear
SXG05S18M6S	18,000	2.1	0.95	11.0	280	86.7	23	10.9	6mm	Rear
SXG05S23S	23,000	2.1	0.95	11.0	280	85.9	23	10.9	1/4"	Rear
SXG05S23M6S	23,000	2.1	0.95	11.0	280	85.9	23	10.9	6mm	Rear
1 hp (.75 kw) – Lever Throttle – Extended – 200 Series Collet										
STXG10S12	12,000	2.2	1.0	12.1	308	78	30	14	1/4"	Rear
STXG10S12M6	12,000	2.2	1.0	12.1	308	78	30	14	6 mm	Rear
STXG10S18	18,000	2.2	1.0	12.1	308	78	30	14	1/4"	Rear
STXG10S18M6	18,000	2.2	1.0	12.1	308	78	30	14	6 mm	Rear
STXG10S23	23,000	2.2	1.0	12.1	308	78	30	14	1/4"	Rear
STXG10S23M6	23,000	2.2	1.0	12.1	308	78	30	14	6 mm	Rear
1 hp (.75 kw) – Lever Throttle – Extended – 300 Series Collet										
STXG10S12S	12,000	2.65	1.20	12.10	308	TBD	30	14.2	1/4"	Rear
STXG10S12M6S	12,000	2.65	1.20	12.10	308	TBD	30	14.2	6mm	Rear
STXG10S18S	18,000	2.65	1.20	12.10	308	TBD	30	14.2	1/4"	Rear
STXG10S18M6S	18,000	2.65	1.20	12.10	308	TBD	30	14.2	6mm	Rear
STXG10S23S	23,000	2.65	1.20	12.10	308	TBD	30	14.2	1/4"	Rear
STXG10S23M6S	23,000	2.65	1.20	12.10	308	TBD	30	14.2	6mm	Rear

¹Not CE Certified

General:

Air Inlet Size: 1/4" NPT • Recommended Hose Size: 3/8" (10 mm) • Performance rated @ 90 psig (6.2 bar) air pressure

Standard Equipment:

Parts List • Safety and Instruction Manual • Collet & Wrenches • Collet Guard (1DS series)

Accessories:

Grinder Accessories, see pages 49



SAFETY PRECAUTION: Read and follow all safety and operating instructions.
WARNING: Face & eye protection must be worn while operating power tools, per ANSI B186.1

RIGHT ANGLE DIE GRINDERS



SAG03S20



SAG03S12S



SAG05S23



SAG7S15



SAG10S18

Performance:

Power: 0.33 hp (0.25 kw) – 1 hp (0.75 kw)
 Speed: 12,000 rpm – 20,000 rpm
 Collet Size: 1/4" & 6 mm

Features:

Lockoff Lever
 Rear Exhaust
 Built-in Speed Control

Right Angle Die Grinders



Model Number	Free Speed	Weight		Length		Sound Level	Air Consumption		Collet Size	Exhaust
	rpm	lb	kg	in	mm	dB(A)	cfm	l/s		
0.3 hp (0.22 kw) – Lever Throttle – 200 Series Collet										
SAG03S12	12,000	1.2	0.55	5.625	140	82.3	11	5.2	1/4"	Rear
SAG03S12M6	12,000	1.2	0.55	5.625	140	82.3	11	5.2	6 mm	Rear
SAG03S20	20,000	1.2	0.55	5.625	140	85.9	11	5.2	1/4"	Rear
SAG03S20M6	20,000	1.2	0.55	5.625	140	85.9	11	5.2	6 mm	Rear
0.3 hp (0.22 kw) – Lever Throttle – 300 Series Collet										
SAG03S12S	12,000	1.15	0.52	5.625	143	82.3	11	5.2	1/4"	Rear
SAG03S12M6S	12,000	1.15	0.52	5.625	143	82.3	11	5.2	6mm	Rear
SAG03S20S	20,000	1.15	0.52	5.625	143	85.9	11	5.2	1/4"	Rear
SAG03S20M6S	20,000	1.15	0.52	5.625	143	85.9	11	5.2	6mm	Rear
0.5 hp (0.37 kw) – Lever Throttle – 200 Series Collet										
SAG05S23	23,000	1.4	0.64	6.375	160	86.0	23	10.8	1/4"	Rear
SAG05S23M6	23,000	1.4	0.64	6.375	160	86.0	23	10.8	6 mm	Rear
0.5 hp (0.37 kw) – Lever Throttle – 300 Series Collet										
SAG05S23S	23,000	1.35	0.61	6.375	162	86.0	23	10.8	1/4"	Rear
SAG05S23M6S	23,000	1.35	0.61	6.375	162	86.0	23	10.8	6mm	Rear
0.70 hp (0.52 kw) – Lever Throttle – 200 Series Collet										
SAG7S12	12,000	2.00	0.90	6.500	165	TBD	25	12	1/4"	Front
SAG7S12M6	12,000	2.00	0.90	6.500	165	TBD	25	12	6mm	Front
SAG7S15	15,000	2.00	0.90	6.500	165	TBD	25	12	1/4"	Front
SAG7S15M6	15,000	2.00	0.90	6.500	165	TBD	25	12	6mm	Front
SAG7S18	18,000	2.00	0.90	6.500	165	TBD	25	12	1/4"	Front
SAG7S18M6	18,000	2.00	0.90	6.500	165	TBD	25	12	6mm	Front
1 hp (0.75 kw) – Lever Throttle – 200 Series Collet										
SAG10S12	12,000	2.7	1.2	9.0	230	78	30	14	1/4"	Rear
SAG10S12M6	12,000	2.7	1.2	9.0	230	78	30	14	6 mm	Rear
SAG10S15	15,000	2.7	1.2	9.0	230	78	30	14	1/4"	Rear
SAG10S15M6	15,000	2.7	1.2	9.0	230	78	30	14	6 mm	Rear
SAG10S18	18,000	2.7	1.2	9.0	230	78	30	14	1/4"	Rear
SAG10S18M6	18,000	2.7	1.2	9.0	230	78	30	14	6 mm	Rear

General:

Air Inlet Size: 1/4" NPT • Recommended Hose Size: 3/8" (10 mm) • Performance rated @ 90 psig (6.2 bar) air pressure

Standard Equipment:

Parts List • Safety and Instruction Manual • Collet, Support Handle (1 HP only) & Wrenches

Accessories:

Grinder Accessories, see pages 49



SAFETY PRECAUTION: Read and follow all safety and operating instructions.
WARNING: Face & eye protection must be worn while operating power tools, per ANSI B186.1

RIGHT ANGLE DIE GRINDERS

Performance:

Power: 0.7 hp (0.52 kw) – 1 hp (0.75 kw)
 Speed: 12,000 rpm – 18,000 rpm
 Collet Size: 1/4" & 6 mm

Features:

Heavy duty double tapered collet
 Teasing throttle
 Lock-off lever
 Heavy Duty spiral bevel gearing for durability and smooth operation
 Compact angle head allows access into tight spaces
 Adjustable speed control
 Grease zerk in gear case



Right Angle Extended Die Grinders

Model Number	Free Speed	Weight		Length		Sound Level	Air Consumption		Collet Size	Exhaust
	rpm	lb	kg	in	mm	dB(A)	cfm	l/s		
1 hp (.75 kw) – Lever Throttle – 200 Series Collet										
SAG10AX12	12,000	3.20	1.45	11.25	286	79.5	30	14.2	1/4"	Rear
SAG10AX12M6	12,000	3.20	1.45	11.25	286	79.5	30	14.2	6mm	Rear
SAG10AX15	15,000	3.20	1.45	11.25	286	84.0	30	14.2	1/4"	Rear
SAG10AX15M6	15,000	3.20	1.45	11.25	286	84.0	30	14.2	6mm	Rear
SAG10AX18	18,000	3.20	1.45	11.25	286	80.5	30	14.2	1/4"	Rear
SAG10AX18M6	18,000	3.20	1.45	11.25	286	80.5	30	14.2	6mm	Rear
.7 hp (0.52 kw) – Lever Throttle										
SAG7AX13	13,000	2.9	1.3	10	254	TBD	25	12	1/4"	Front
SAG7AX13M6	13,000	2.9	1.3	10	254	TBD	25	12	6 mm	Front
SAG7AX16	16,000	2.9	1.3	10	254	TBD	25	12	1/4"	Front
SAG7AX16M6	16,000	2.9	1.3	10	254	TBD	25	12	6 mm	Front
SAG7AX20	20,000	2.9	1.3	10	254	TBD	25	12	1/4"	Front
SAG7AX20M6	20,000	2.9	1.3	10	254	TBD	25	12	6 mm	Front

General:

Air Inlet Size: 1/4" NPT • Recommended Hose Size: 3/8" (10 mm) • Performance rated @ 90 psig (6.2 bar) air pressure

Standard Equipment:

Parts List • Safety and Instruction Manual • Collet, Support Handle (1 HP only) & Wrenches

Accessories:

Grinder Accessories, see pages 49

RIGHT ANGLE TYPE 27 WHEEL GRINDERS

Performance:

Power: 0.7 hp (0.52 kw) – 1 hp (0.75 kw)
 Speed: 12,000 rpm – 18,000 rpm
 Wheel Capacity: 3" (75 mm) – 5" (127 mm)

Features:

Non-Governed
 Lockoff Lever
 Adjustable Guard



Right Angle Type 27 Extended Wheel Grinders

Model Number	Free Speed	Wheel Capacity		Weight		Length		Sound Level	Air Consumption		Spindle Thread	Exhaust
	rpm	In	MM	lb	kg	in	mm	dB(A)	cfm	l/s		
1 hp (.75 kw) – Lockoff Lever Throttle												
SWG10AX124	12,000	4.0	100	3.6	1.63	11.25	285	91.0	35	17	3/8" - 24	Rear
SWG10AX1245	12,000	4.5	115	3.7	1.68	11.25	285	86.0	35	17	5/8" - 11	Rear
SWG10AX125	12,000	5.0	127	3.8	1.72	11.25	285	83.7	35	17	5/8" - 11	Rear
.7 hp (0.52 kw) – Lever Throttle												
SWG7AX134	13,300	4.0	100	3.5	1.6	10	254	87.4	25	12	3/8" - 24	Front
SWG7AX1345	13,300	4.5	115	3.5	1.6	10	254	88	25	12	5/8" - 11	Front
SWG7AX203	20,000	3.0	75	3.5	1.6	10	254	TBD	25	12	3/8" - 24	Front

General:

1 hp models: Air Inlet Size: 3/8" NPT • Recommended Hose Size: 3/8" (10 mm) • Performance rated @ 90 psig (6.2 bar) air pressure

.7 hp models: Air Inlet Size: 1/4" NPT • Recommended Hose Size: 3/8" (10 mm) • Performance rated @ 90 psig (6.2 bar) air pressure

Standard Equipment:

Parts List • Safety and Instruction Manual • Spindle Wrenches • Wheel Guard • Support Handle • Mounting Flange & Nut

Accessories:

Grinder Accessories, see pages 49



SAFETY PRECAUTION: Read and follow all safety and operating instructions.
WARNING: Face & eye protection must be worn while operating power tools, per ANSI B186.1

RIGHT ANGLE TYPE 27 WHEEL GRINDERS



1285L



SWG10S183



SWG10A1245



SWG10S1245



Performance:

Power: 1 hp (0.75 kw)
 Speed: 6000 rpm – 18,000 rpm
 Wheel Capacity: 3" (75 mm) – 7" (175 mm) diameter

Features:

Governed & Non-Governed
 Lockoff Lever Throttle
 Side Exhaust: 1285L
 Rear Exhaust: SWG Series

Right Angle Type 27 Wheel Grinders

Model Number	Free Speed		Wheel Capacity		Weight		Length		Sound Level	Air Consumption Under Load		Air Consumption Free Speed		Spindle Thread
	rpm		in	mm	lb	kg	in	mm	dB(A)	cfm	l/s	cfm	l/s	
1 hp (0.75 kw) – Lockoff Lever Throttle														
SWG10S124	12,000		4.0	100	3.0	1.6	8.3	210	77	N/A	N/A	35	17	3/8"-24
SWG10S1245	12,000		4.5	115	3.0	1.6	8.3	210	77	N/A	N/A	35	17	5/8"-11
SWG10S183	18,000		3.0	75	2.5	1.1	7.5	190	77	N/A	N/A	35	17	3/8"-24
1 hp (0.75 kw) – Lockoff Lever Throttle														
SWG10A124	12,000		4.0	100	2.5	1.1	7.75	195	86.4	N/A	N/A	35	17	3/8" - 24
SWG10A1245	12,000		4.5	115	2.6	1.17	7.75	195	84.9	N/A	N/A	35	17	5/8"-11
SWG10A125	12,000		5.0	127	2.7	1.22	7.75	195	83.7	N/A	N/A	35	17	5/8" - 11
1 hp (0.75 kw) – Lockoff Lever Throttle														
SWG10AX1245	12,000		4.5	115	3.7	1.68	11.25	285	86.0	N/A	N/A	35	17	5/8"-11
1 hp (0.75 kw) – Governed Speed – Lockoff Lever Throttle														
1285L	6000		7.0	175	5.9	2.7	12.4	315	85	35	17	18	8	5/8"-11

General: Air Inlet Size: 1/4" NPT • Recommended Hose Size: 3/8" (10 mm) • Performance rated @ 90 psig (6.2 bar) air pressure
Standard Equipment: Parts List • Safety and Instruction Manual • Spindle Wrenches • Wheel Guard • Support Handle • Mounting Flange & Nut
Accessories: Grinder Accessories, see pages 49

VERTICAL TYPE 27 WHEEL GRINDERS

Performance:

Power: 1 hp (0.75 kw) – 3 hp (2.2 kw)
 Speed: 4500 rpm – 6000 rpm
 Wheel Capacity: 7" (175 mm) – 9" (230 mm) diameter

Features:

Governed & Non-Governed
 Lockoff Lever & Thumb Throttle
 Side Exhaust



VG20AL-60D7



1291



Vertical Type 27 Wheel Grinders

Model Number	Free Speed		Wheel Capacity		Weight		Length		Sound Level	Air Consumption Under Load		Air Consumption Free Speed		Spindle Thread
	rpm		in	mm	lb	kg	in	mm	dB(A)	cfm	l/s	cfm	l/s	
1 hp (0.75 kw) – Non-Governer Speed – Thumb Throttle														
1291L	6000		7	175	5.0	2.3	7.2	183	80	30	14	38	18	5/8"-11
1 hp (0.75 kw) – Non-Governer Speed – Thumb Throttle														
1291	6000		7	175	5.0	2.3	7.2	183	80	30	14	38	18	5/8"-11
2 hp (1.5 kw) – Class Vertical Grinders – Governed Speed – Lever Throttle														
VG20AL-45D9	4500		9	230	7.4	3.3	5.5	145	85	75	35	26	12	5/8"-11
VG20AL-60D7	6000		7	175	7.4	3.3	5.5	145	85	75	35	26	12	5/8"-11
VG20AL-60D9	6000		9	230	7.4	3.3	5.5	145	85	75	35	26	12	5/8"-11
3 hp (2.2 kw) – Class Vertical Grinders – Governed Speed – Lever Throttle														
VG30AL-45D7	4500		7	175	9.5	4.3	6.4	165	84	90	42	39	18	5/8"-11
VG30AL-45D9	4500		9	230	9.5	4.3	6.4	165	84	90	42	39	18	5/8"-11
VG30AL-60D7	6000		7	175	9.5	4.3	6.4	165	84	90	42	39	18	5/8"-11
VG30AL-60D9	6000		9	230	9.5	4.3	6.4	165	84	90	42	39	18	5/8"-11

General: Air Inlet Size: 1/4" NPT (1290 series); 1/2" NPT (V series) • Recommended Hose Size: 3/8" (10 mm) (1290 series); 1/2" (13 mm) (V series)
 Performance rated @ 90 psig (6.2 bar) air pressure
Standard Equipment: Parts List • Safety and Instruction Manual • Spindle Wrenches • Wheel Guard • Mounting Flange & Nut
Accessories: Grinder Accessories, see pages 49



SAFETY PRECAUTION: Read and follow all safety and operating instructions.
WARNING: Face & eye protection must be worn while operating power tools, per ANSI B186.1

VERTICAL TYPE 6 & 11 WHEEL GRINDERS

Performance:

Power: 2 hp (1.5 kw) – 3 hp (2.2 kw)
 Speed: 6000 rpm
 Wheel Capacity: 6" (150 mm)

Features:

Governed Speed
 Lockoff Lever
 Side Exhaust



Vertical Type 6 & 11 Wheel Grinders

Model Number	Free Speed	Wheel Capacity		Weight		Length		Sound Level	Air Consumption Under Load		Air Consumption Free Speed		Spindle Thread
	rpm	in	mm	lb	kg	in	mm	dB(A)	cfm	l/s	cfm	l/s	
2 hp (1.5 kw) – Class Vertical Grinders – Governed Speed – Lever Throttle													
VG20AL-60C6	6000	6	150	7.4	3.3	5.5	145	85	75	35	26	12	5/8"-11
3 hp (2.2 kw) – Class Vertical Grinders – Governed Speed – Lever Throttle													
VG30AL-60C6	6000	6	150	9.5	4.3	6.4	165	84	90	42	39	18	5/8"-11

General:

Air Inlet Size: 1/2" NPT • Recommended Hose Size: 1/2" (13 mm) • Performance rated @ 90 psig (6.2 bar) air pressure

Standard Equipment:

Parts List • Safety and Instruction Manual • Spindle Wrenches • Wheel Guard • Mounting Flange & Nut

Accessories:

Grinder Accessories, see pages 49

HORIZONTAL GRINDERS

Performance:

Power: 2 hp (1.5 kw) – 3 hp (2.2 kw)
 Speed: 4500 rpm – 8000 rpm
 Wheel Capacity: 3" (75 mm) – 8" (200 mm)

Features:

Governed Speed
 Lever Throttle
 Side Exhaust



Horizontal Wheel Grinders

Model Number	Free Speed	Wheel Capacity		Weight		Length		Sound Level	Air Consumption Under Load		Air Consumption Free Speed		Spindle Thread
	rpm	in	mm	lb	kg	in	mm	dB(A)	cfm	l/s	cfm	l/s	
2 hp (1.5 kw) – Class Horizontal Grinders – Governed Speed – Lever Throttle													
HG20AL-45S8	4500	8	200	10.5	4.8	20.8	530	85	75	35	26	12	5/8"-11
HG20AL-60S6	6000	6	150	10.5	4.8	20.8	530	85	75	35	26	12	5/8"-11
HG20AL-80P3	8000	3	75	10.5	4.8	20.8	530	85	75	35	26	12	5/8"-11
3 hp (2.2 kw) – Class Horizontal Grinders – Governed Speed – Lever Throttle													
HG30AL-45S8	4500	8	200	12.5	5.6	21.8	550	84	90	42	39	18	5/8"-11
HG30AL-60S6	6000	6	150	12.5	5.6	21.8	550	84	90	42	39	18	5/8"-11
HG30AL-80P3	8000	3	75	12.5	5.6	21.8	550	84	90	42	39	18	5/8"-11

General:

Air Inlet Size: 1/2" NPT • Recommended Hose Size: 1/2" (13 mm) • Performance rated @ 90 psig (6.2 bar) air pressure

Standard Equipment:

Parts List • Safety and Instruction Manual • Spindle Wrenches • Wheel Guard • Mounting Flange & Nut

Accessories:

Grinder Accessories, see pages 49

MATERIAL REMOVAL TOOL

Performance:

Power: 0.90 hp (0.70 kw)
 Speed: 4000 rpm

Features:

Removable Support Handle
 Lockoff Lever
 Planetary Gear for Increased Torque



Material Removal Tool

Model Number	Free Speed	Weight		Length		Sound Level	Air Consumption		Exhaust
	rpm	lb	kg	in	mm	dB(A)	cfm	l/s	
ST2L1410	4000	3.3	1.5	13	330	84	24	11	Rear

General:

Air Inlet Size: 1/4" NPT • Recommended Hose Size: 3/8" (10 mm) • Performance rated @ 90 psig (6.2 bar) air pressure

Standard Equipment:

Parts List • Safety and Instruction Manual • Fine Belt (68813) • Coarse Belt (68814) • Eraser (68815) • Support Handle

Accessories:

Material Removal Tool Accessories, see pages 49



SAFETY PRECAUTION: Read and follow all safety and operating instructions.
WARNING: Face & eye protection must be worn while operating power tools, per ANSI B186.1

Belts and Erasers



Hub Set 68918



Eraser 68815



Course Wire Belt 68814



Fine Wire Belt 68813



Medium Stainless Steel Wire Belt 68917



Fine Stainless Steel Wire Belt 68915

Part Number	Description
68918	11mm Hub Set
68815	Rubber Eraser
68814	Course Wire Belt, 23 mm Wide
68910	Course Wire Belt, 11 mm Wide
68911	Medium Wire Belt, 23 mm Wide
68912	Medium Wire Belt, 11 mm Wide
68813	Fine Wire Belt, 23 mm Wide
68913	Fine Wire Belt, 11 mm Wide
68916	Medium Stainless Steel Wire Belt, 23 mm Wide
68917	Medium Stainless Steel Wire Belt, 11 mm Wide
68914	Fine Stainless Steel Wire Belt, 23 mm Wide
68915	Fine Stainless Steel Wire Belt, 11 mm Wide

Collets



21126



44440

Style	Capacity	Part Number	For Use On
Sioux	1/8"	44522	
	3/16"	44523	1DA, 1DS, 1954HP,
	1/4"	44440	1956HP, 1962,
	3 mm	66037	1963, 1964, 2S1940
	6 mm	66038	
100 Series	1/4"	21126	
	3/8"	21125	1985
	1/2"	21124	

Wheel Guards



2336

Part Number	Wheel Type	Wheel Diameter		For Use On
		in	mm	
2321	27	7	180	1285, 1285L
2336	27	7	180	1291, 1921L

Mounting Accessories

7" and 9" Type 27 Depressed Center Wheel
For use on 5/8" - 11 threaded spindles



510

Part Number	Description
510	Flange Adapter Kit
25894	Washers
512	Flange Nut
30110	3/8" Hex Wrench

Signature Series Collets

200 SERIES

Heavy Duty Double Tapered Collet
Collet Nut Collet Collet Body



Part Number	Description
74071	Collet Nut
74072	Collet (1/8")
74073	Collet (3/16")
74074	Collet (1/4")
68030	Collet (3/8")
74075	Collet (3 mm)
74076	Collet (6 mm)
68056	Collet (8 mm)
77057	Collet Body SDG Series
74070	Collet Body (1 HP)

300 SERIES

Heavy Duty Double Tapered Collet
Collet Nut Collet Collet Body



Part Number	Description
74128	Collet Nut
74124	Collet (3/32")
74121	Collet (1/8")
74120	Collet (1/4")
74122	Collet (3 mm)
74123	Collet (6 mm)
77505	Collet Body SAS Series
74125	Collet Body SDG Series



SAFETY PRECAUTION: Read and follow all safety and operating instructions.
WARNING: Face & eye protection must be worn while operating power tools, per ANSI B186.1

FINISHING

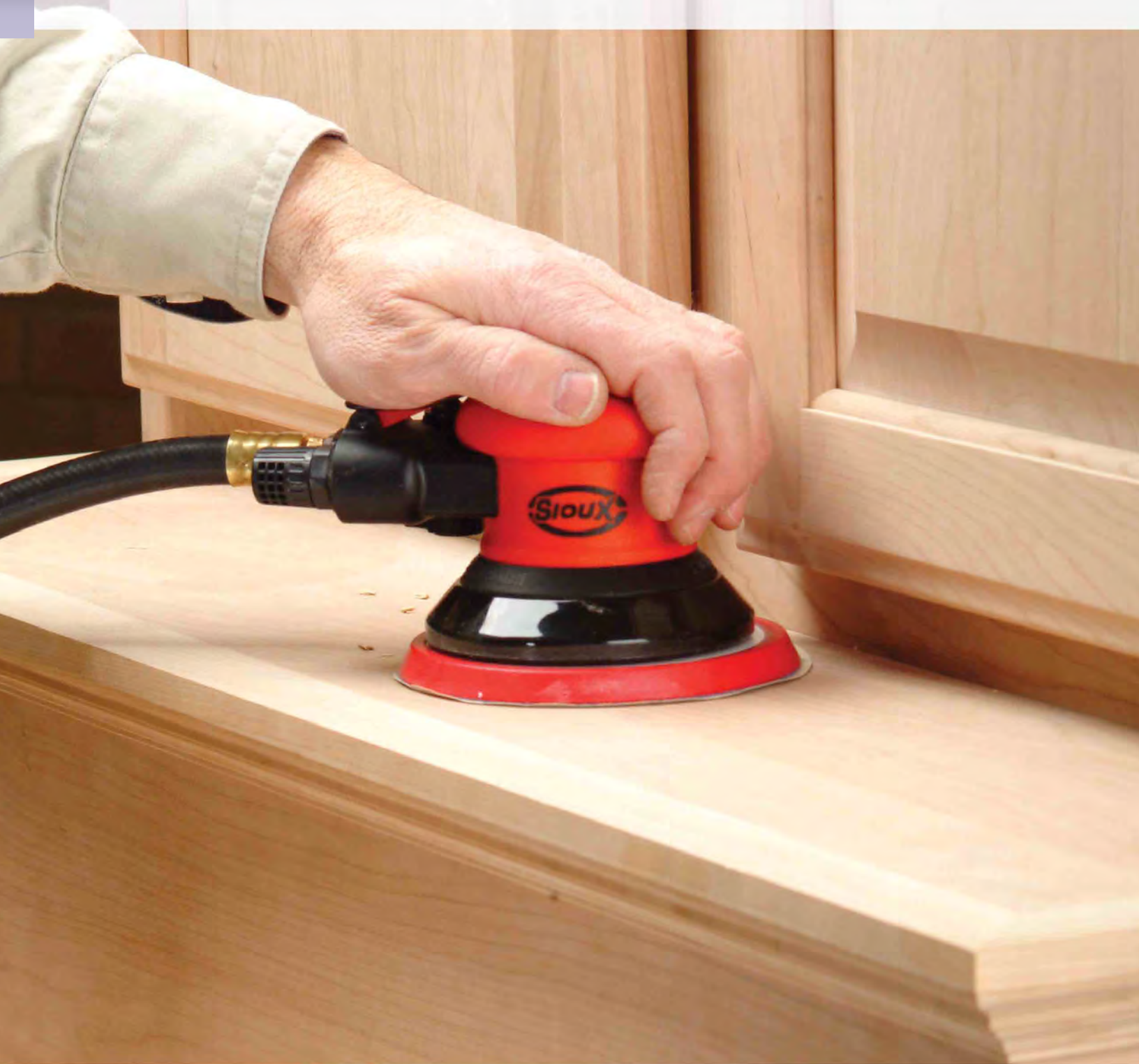

Index	
Sanders	52 – 56
Polishers	56
Finishing Accessories	57 – 59

FINISHING

The Best Way To A Great Finish

Today's manufacturing techniques are constantly changing and improving. This has increased the demands for sanders, polishers and buffers, making them a key segment of the process. Improvements in the industry now result in less waste on castings and molded parts, which shifts the emphasis from material removal to surface finishing. Sioux Tools offers a complete line of state-of-the-art orbital sanders, polishers and buffers that will produce the quality finish you require on your final product.

Sioux sanders are engineered to cover the full range of applications in metal, composite, and wood finishing. Our innovative, lightweight designs ensure they perform to the highest standards while still being comfortable to operate. Each delivers unsurpassed power and performance, resulting in the perfect finish.

Fit to your application

Different applications require different finishing tools. That's why Sioux Tools offers a variety of sanders and polishers with a wide range of configurations.

The RO2512 Series Random Orbital Sanders come with an orbit diameter of either 3/8" (10 mm), 3/16" (5 mm) or 3/32" (3 mm) and a choice of non-vacuum, self-contained Venturi vacuum or remote vacuum ready.

Variety to choose from

We also offer pistol grip, right angle, vertical, and straight sanders and polishers. Many of these come with your choice of throttle controls that allow the operator to work the way that's most comfortable.



Finishing Safety

Flying particles can cause eye injury. Proper eye protection must be worn at all times by tools user and bystanders.

A grinding wheel that bursts can cause injury or death. Never mount a grinding wheel or a cutoff wheel on a sander or polisher.

Breathing grinding dust can cause injury. Do not breathe grinding dust. Use approved mask.

Sanders and polishers that do not come to a complete stop before setting aside can cause injury. Be sure the tool has come to a complete stop before setting it aside.

Explosions and fires can cause injury. Only sand metal if the area is free of combustible or explosive materials or vapors.

Contact with sanding disks can cause injury. Wear protective clothing and gloves to protect hands. Keep hands and other body parts away from sanding pads and disks to prevent cutting or pinching.

Sanding or polishing pads, disks or accessories that burst can cause injury. Make sure disks or accessories have a higher speed rating than the tool. Do not exceed rated air pressure.

Prolonged exposure to vibration or an excessive exposed portion of the edge of a disk can cause injury. When using self adhesive sanding disks, make sure to mount them concentrically on the pad.

Tools starting unexpectedly can cause injury. Always remove tool from air supply and activate trigger to bleed air line before making any adjustments, changing accessories, or doing any maintenance or service on tool.

Tools that perform unpredictably can cause injury. Use only sanding and polishing pads, disks and accessories provided or specified by Sioux Tools.

SIGNATURE SERIES RANDOM ORBITAL SANDERS



RO2512-50SNP



RO2512-50SRP



RO2512-50FVP

Performance:

Power: 0.25 hp (0.19 kw)
Speed: 12,000 rpm

Features:

3/32" (3 mm), 3/16" (5 mm) & 3/8" (10 mm) Orbit Diameters
Built-in Speed Control
Ergonomic 24-Position Indexable Grip
Non-Vacuum, Venturi Vacuum & Remote Vacuum



RO2512 Series Random Orbital Sanders

Model Number		Free Speed	Pad Size		Orbit Diameter		Weight		Height		Air Consumption		Sound Level
PSA Pad	H & L Pad	rpm	in	mm	in	mm	lb	kg	in	mm	cfm	l/s	dB(A)
0.25 hp (0.19 kw) – 5/16"-24 Spindle Thread – Non-Vacuum													
RO2512-30FNP	RO2512-30FNH	12,000	3	75	3/32	3	1.5	0.7	3.3	83	13	6	81
RO2512-30SNP	RO2512-30SNH	12,000	3	75	3/16	5	1.5	0.7	3.3	83	13	6	81
RO2512-35FNP	RO2512-35FNH	12,000	3.5	90	3/32	3	1.5	0.7	3.3	83	13	6	81
RO2512-35SNP	RO2512-35SNH	12,000	3.5	90	3/16	5	1.5	0.7	3.3	83	13	6	81
RO2512-50FNP	RO2512-50FNH	12,000	5	125	3/32	3	1.5	0.7	3.3	83	13	6	81
RO2512-50SNP	RO2512-50SNH	12,000	5	125	3/16	5	1.5	0.7	3.3	83	13	6	81
RO2512-50CNP	RO2512-50CNH	12,000	5	125	3/8	10	1.5	0.7	3.3	83	13	6	81
RO2512-60FNP	RO2512-60FNH	12,000	6	150	3/32	3	1.5	0.7	3.3	83	13	6	81
RO2512-60SNP	RO2512-60SNH	12,000	6	150	3/16	5	1.5	0.7	3.3	83	13	6	81
RO2512-60CNP	RO2512-60CNH	12,000	6	150	3/8	10	1.5	0.7	3.3	83	13	6	81
0.25 hp (0.19 kw) – 5/16"-24 Spindle Thread – Remote Vacuum Ready													
RO2512-30FRP	RO2512-30FRH	12,000	3	75	3/32	3	1.5	0.7	3.3	83	13	6	81
RO2512-30SRP	RO2512-30SRH	12,000	3	75	3/16	5	1.5	0.7	3.3	83	13	6	81
RO2512-35FRP	RO2512-35FRH	12,000	3.5	90	3/32	3	1.5	0.7	3.3	83	13	6	81
RO2512-35SRP	RO2512-35SRH	12,000	3.5	90	3/16	5	1.5	0.7	3.3	83	13	6	81
RO2512-50FRP	RO2512-50FRH	12,000	5	125	3/32	3	1.5	0.7	3.3	83	13	6	81
RO2512-50SRP	RO2512-50SRH	12,000	5	125	3/16	5	1.5	0.7	3.3	83	13	6	81
RO2512-50CRP	RO2512-50CRH	12,000	5	125	3/8	10	1.5	0.7	3.3	83	13	6	81
RO2512-60FRP	RO2512-60FRH	12,000	6	150	3/32	3	1.5	0.7	3.3	83	13	6	81
RO2512-60SRP	RO2512-60SRH	12,000	6	150	3/16	5	1.5	0.7	3.3	83	13	6	81
RO2512-60CRP	RO2512-60CRH	12,000	6	150	3/8	10	1.5	0.7	3.3	83	13	6	81
0.25 hp (0.19 kw) – 5/16"-24 Spindle Thread – Self-contained Venturi Vacuum													
RO2512-30FVP	RO2512-30FVH	12,000	3	75	3/32	3	1.5	0.7	3.3	83	13	6	81
RO2512-30SVP	RO2512-30SVH	12,000	3	75	3/16	5	1.5	0.7	3.3	83	13	6	81
RO2512-35FVP	RO2512-35FVH	12,000	3.5	90	3/32	3	1.5	0.7	3.3	83	13	6	81
RO2512-35SVP	RO2512-35SVH	12,000	3.5	90	3/16	5	1.5	0.7	3.3	83	13	6	81
RO2512-50FVP	RO2512-50FVH	12,000	5	125	3/32	3	1.5	0.7	3.3	83	13	6	81
RO2512-50SVP	RO2512-50SVH	12,000	5	125	3/16	5	1.5	0.7	3.3	83	13	6	81
RO2512-50CVP	RO2512-50CVH	12,000	5	125	3/8	10	1.5	0.7	3.3	83	13	6	81
RO2512-60FVP	RO2512-60FVH	12,000	6	150	3/32	3	1.5	0.7	3.3	83	13	6	81
RO2512-60SVP	RO2512-60SVH	12,000	6	150	3/16	5	1.5	0.7	3.3	83	13	6	81
RO2512-60CVP	RO2512-60CVH	12,000	6	150	3/8	10	1.5	0.7	3.3	83	13	6	81

General:

Air Inlet Size: 1/4" NPT • Recommended Hose Size: 3/8" (10 mm) • Performance rated @ 90 psig (6.2 bar) air pressure

Standard Equipment:

Parts List • Safety and Instruction Manual • Comfort Grip • Backing Pad & Wrench

Accessories:

Sander Accessories, see pages 57 – 59



SAFETY PRECAUTION: Read and follow all safety and operating instructions.
WARNING: Face & eye protection must be worn while operating power tools, per ANSI B186.1

ORBITAL JITTERBUG SANDERS



RO2510-44FNC

Performance:

Power: 0.25 hp (0.19 kw)
Speed: 10,000 rpm

Features:

Built-in Speed Control
Ergonomic 24-Position Indexable Grip

Orbital Jitterbug Sanders



Model Number	Paper Size		Orbit Diameter		Weight		Height		Air Consumption Free Speed		Sound Level
	in	mm	in	mm	lb	kg	in	mm	cfm	l/s	dB(A)
0.25 hp (0.19 kw)											
RO2510-44FNC	3-3/4 x 4-1/4	95 x 105	3/32	3	1.8	0.8	3.5	90	13	6	81

General:

Air Inlet Size: 1/4" NPT • Recommended Hose Size: 3/8" (10 mm) • Performance rated @ 90 psig (6.2 bar) air pressure

Standard Equipment:

Parts List • Safety and Instruction Manual

Accessories:

Sander Accessories, see pages 57 – 59

GEARED ORBITAL SANDERS



GO459-60SNP



GO459-80SRP

Performance:

Power: 0.45 hp (0.34 kw)
Speed: 900 rpm

Features:

3/16" (5 mm) Orbit Diameter
Built-in Speed Control
Lever Throttle
Vacuum & Remote Vacuum
Ergonomic 24-Position Indexable Grip

Geared Orbital Sanders



Model Number		Free Speed rpm	Pad Size		Weight		Height		Air Consumption		Sound Level
PSA Pad	H & L Pad		in	mm	lb	kg	in	mm	cfm	l/s	dB(A)
.45 HP (0.34 kw) Non-Vacuum											
GO459-60SNP	GO459-60SNH	900	6	150	4.4	2.0	5	127	15	7	82
GO459-80SNP	GO459-80SNH	900	8	200	4.4	2.0	5	127	15	7	82
.45 HP (0.34 kw) Remote Vacuum											
GO459-60SRP	GO459-60SRH	900	6	150	4.4	2.0	5	127	15	7	82
GO459-80SRP	GO459-80SRH	900	8	200	4.4	2.0	5	127	15	7	82

General:

Air Inlet Size: 1/4" NPT • Recommended Hose Size: 3/8" (10 mm) • Performance rated @ 90 psig (6.2 bar) air pressure

Standard Equipment:

Parts List • Safety and Instruction Manual

Accessories:

Sander Accessories, see pages 57 – 59



SAFETY PRECAUTION: Read and follow all safety and operating instructions.
WARNING: Face & eye protection must be worn while operating power tools, per ANSI B186.1

600 SERIES RANDOM ORBITAL SANDERS

Performance:

Power: 0.40 hp (0.30 kw)
Speed: 10,000 rpm

Features:

3/16" (5 mm) Orbit Diameter
Built-in Speed Control
Aluminum Housing
Palm & Lever Throttle



658

600 Series Random Orbital Sanders

Model Number		Free Speed	Pad Size		Orbit Diameter		Weight		Height		Air Consumption		Sound Level
PSA Pad	H & L Pad	rpm	in	mm	in	mm	lb	kg	in	mm	cfm	l/s	dB(A)
0.40 hp (0.30 kw) – Palm Throttle													
PS690 ¹		10,000	5	125	3/16	5	2.9	1.3	4.2	107	20	9	85
697 ¹		10,000	6	150	3/16	5	2.9	1.3	4.2	107	20	9	85
0.40 hp (0.30 kw) – Dual Action – Lever Throttle													
658 ¹		10,000	5	125	3/16	5	3.2	1.5	4.2	107	20	9	85

For remote vacuum ready add suffix V

¹Not CE Certified

General:

Air Inlet Size: 1/4" NPT • Recommended Hose Size: 3/8" (10 mm) • Performance rated @ 90 psig (6.2 bar) air pressure

Standard Equipment:

Parts List • Safety and Instruction Manual • Backing Pad & Wrench

Accessories:

Sander Accessories, see pages 57 – 59

PISTOL GRIP SANDERS



SPS10P18



SDG10P18

Performance:

Power: 1 hp (0.75 kw)
Speed: 18,000 rpm – 21,000 rpm

Features:

Trigger Start
Down-Handle Exhaust
Comfort Grip



Pistol Grip Sanders

Model Number	Free Speed	Weight		Height		Air Consumption Free Speed		Sound Level
	rpm	lb	kg	in	mm	cfm	l/s	dB(A)
1 hp (0.75 kw) – 5" (125 mm) Diameter Backing Pad								
SPS10P18	18,000	1.7	0.8	4.5	115	35	17	80
1 hp (0.75 kw) – 1/4" Collet								
SDG10P18	18,000	1.7	0.8	5.8	145	35	17	80
SDG10P21	21,000	1.7	0.8	5.8	145	35	17	80

General:

Air Inlet Size: 1/4" NPT • Recommended Hose Size: 3/8" (10 mm) • Performance rated @ 90 psig (6.2 bar) air pressure

Standard Equipment:

Parts List • Safety and Instruction Manual • Comfort Grip

Accessories:

Sander Accessories, see pages 57 – 59



SAFETY PRECAUTION: Read and follow all safety and operating instructions.
WARNING: Face & eye protection must be worn while operating power tools, per ANSI B186.1

RIGHT ANGLE SANDERS



SAS03S122-20



SAS05S232-20



SAS10A182-20



77016 Threaded Arbor



300 Series Collet

Performance:

Power: 0.33 hp (0.25 kw) – 1 hp (.75 kw)
Speed: 12,000 rpm – 23,000 rpm

Features:

Lockoff Lever Throttle
Front, Rear, and Vacuum Exhaust
Comfort Grip



Right Angle Disc Sanders

Model Number	Free Speed	Weight		Length		Air Consumption Free Speed		Sound Level	Spindle Thread
	rpm	lb	kg	in	mm	cfm	l/s	dB(A)	
0.3 hp (.22 kw) – Lever Throttle									
SAS03S122-20	12,000	1.1	.5	5.625	143	11	5.2	82.2	1/4"-20
SAS03S202-20	20,000	1.1	.5	5.625	143	11	5.2	82.9	1/4"-20
0.5 hp (.37 kw) – Lever Throttle									
SAS05S232-20	23,000	1.3	.59	5.625	143	23	10.3	88.6	1/4"-20
1 hp (.75 kw) – Lever Throttle									
SAS10A122-20	12,000	2.15	.98	7.5	190	30	14	84.6	1/4"-20
SAS10A152-20	15,000	2.15	.98	7.5	190	30	14	TBD	1/4"-20
SAS10A182-20	18,000	2.15	.98	7.5	190	30	14	TBD	1/4"-20

General:

Air Inlet Size: 1/4" NPT • Recommended Hose Size: 3/8" (10 mm) • Performance rated @ 90 psig (6.2 bar) air pressure

Standard Equipment:

Parts List • Safety and Instruction Manual • Support Handle (1 hp Models) • Spindle Wrenches, 300 Series Collet, 1/4-20 Threaded Arbor

Accessories:

Sander Accessories, see pages 57 – 59

RIGHT ANGLE SANDERS



SAS10S125



SAS10A125



SAS10AX125



1287L

Performance:

Power: 1 hp (0.75 kw)
Speed: 6000 rpm – 12,000 rpm

Features:

Governed & Non-Governed
Lockoff Lever Throttle
Rear Exhaust on SAS Series



Right Angle Sanders

Model Number	Free Speed	Pad Diameter		Weight		Length		Air Consumption Under Load		Air Consumption Free Speed		Sound Level	Spindle Thread
	rpm	in	mm	lb	kg	in	mm	cfm	l/s	cfm	l/s	dB(A)	
1 hp (0.75 kw) – Lockoff Lever Throttle – Rear Exhaust													
SAS10S125	12,000	5	125	3.5	1.6	8.3	210	N/A	N/A	35	17	77	3/8 – 24
SAS10A125	12,000	5	125	2.2	1.0	7.75	134	N/A	N/A	35	17	84.1	5/8"-11
SAS10AX125	12,000	5	125	3.2	1.45	11.25	285	N/A	N/A	35	17	83.2	5/8"-11
1 hp (0.75 kw) – Governed Speed Control – Lockoff Lever Throttle													
1287L ¹	6000	7	175	5.9	2.7	11.3	287	35	17	18	8	85	5/8"-11

¹Not CE certified.

General:

Air Inlet Size: 1/4" NPT • Recommended Hose Size: 3/8" (10 mm) • Performance rated @ 90 psig (6.2 bar) air pressure

Standard Equipment:

Parts List • Safety and Instruction Manual • Support Handle • Spindle Wrenches • Backing Pad & Nut

Accessories:

Sander Accessories, see pages 57 – 59



SAFETY PRECAUTION: Read and follow all safety and operating instructions.
WARNING: Face & eye protection must be worn while operating power tools, per ANSI B186.1

VERTICAL SANDERS



Performance:

Power: 1 hp (0.75 kw) – 2 hp (1.5 kw)
 Speed: 6000 rpm – 7200 rpm

Features:

Governed & Non-Governed
 Lever & Thumb Throttle
 Side Exhaust
 Overspeed Shutoff Protection (V Series)

Vertical Sanders

Model Number	Free Speed		Pad Diameter		Weight		Length		Air Consumption Under Load		Air Consumption Free Speed		Sound Level	Spindle Thread
	rpm		in	mm	lb	kg	in	mm	cfm	l/s	cfm	l/s	dB(A)	
1 hp (0.75 kw) – Thumb Throttle														
1290	6000		7	175	4.1	1.9	7.2	183	30	14	38	18	80	5/8"-11
1 hp (0.75 kw) – Lever Throttle														
1290L	6000		7	175	4.1	1.9	7.2	183	30	14	38	18	80	5/8"-11
2 hp (1.5 kw) Class Vertical Sanders – Governed Speed Control – Lockoff Lever Throttle														
VS20AL-609	6000		9	230	7.4	3.3	5.5	145	75	35	26	12	85	5/8"-11
VS20AL-727	7200		7	175	7.4	3.3	5.5	145	75	35	26	12	85	5/8"-11

General: Air Inlet Size: 1/4" NPT • Recommended Hose Size: 3/8" (10 mm) • Performance rated @ 90 psig (6.2 bar) air pressure

Standard Equipment: Parts List • Safety and Instruction Manual • Spindle Wrenches • Backing Pad & Nut

Accessories: Sander Accessories, see pages 57 – 59

RIGHT ANGLE POLISHERS

Performance:

Power: 1 hp (0.75 kw)
 Speed: 3000 rpm

Features:

Governed Speed Control
 Lockoff Lever Throttle
 Spindle Lock
 Remote Exhaust



Right Angle Polishers

Model Number	Free Speed		Pad Diameter		Weight ¹		Length		Air Consumption Under Load		Air Consumption Free Speed		Sound Level	Spindle Thread
	rpm		in	mm	lb	kg	in	mm	cfm	l/s	cfm	l/s	dB(A)	
1 hp (0.75 kw) – Lockoff Lever Throttle														
1238L	3000		8	200	7.9	3.6	11.3	287	33	16	16	8	75	5/8"-11

¹ Weight includes pad & holder.

General: Air Inlet Size: 1/4" NPT • Recommended Hose Size: 3/8" (10 mm) • Performance rated @ 90 psig (6.2 bar) air pressure

Standard Equipment: Parts List • Safety and Instruction Manual • Remote Exhaust • Support Handle • Backing Pad & Nut • Wool Polishing Pad

Accessories: Polisher Accessories, see pages 57 – 59

VERTICAL POLISHERS

Performance:

Power: 1 hp (0.75 kw)
 Speed: 2000 rpm – 3000 rpm

Features:

Lever & Thumb Throttle
 Side Exhaust
 Comfort Grips



Vertical Polishers

Model Number	Free Speed		Pad Diameter		Weight ¹		Length		Air Consumption Under Load		Air Consumption Free Speed		Sound Level	Spindle Thread
	rpm		in	mm	lb	kg	in	mm	cfm	l/s	cfm	l/s	dB(A)	
1 hp (0.75 kw) – Thumb Throttle														
1296	2000		8	200	4.1	1.9	7.1	180	30	14	38	18	80	5/8"-11
1292	3000		8	200	4.1	1.9	7.1	180	30	14	38	18	80	5/8"-11
1 hp (0.75 kw) – Lever Throttle														
1292L	3000		8	200	4.1	1.9	7.1	180	30	14	38	18	80	5/8"-11

¹ Weight includes pad & holder.

General: Air Inlet Size: 1/4" NPT • Recommended Hose Size: 3/8" (10 mm) • Performance rated @ 90 psig (6.2 bar) air pressure

Standard Equipment: Parts List • Safety and Instruction Manual • Spindle Wrenches • Backing Pad & Nut • Polishing Pad

Accessories: Polisher Accessories, see pages 57 – 59



SAFETY PRECAUTION: Read and follow all safety and operating instructions.
WARNING: Face & eye protection must be worn while operating power tools, per ANSI B186.1

Comfort Grips



66667

Part Number	Description	For Use On
66667	Cushion Grip	690 series

Support Handle

Part No 2362

For use on 2L series straight sanders



Support Handle

Part No 2357

For use on 1965, 1965-5/8" sanders



Spindle Adapter Kits

For use on 2L series straight sanders



500A

Part Number	Adapts Spindle Threads		Length	
	From	To	in	mm
500	3/8"-24	1/2"-13	3	76
500A	1/2"-20	1/2"-13	3	76

Speed-Lok Backing Pads

For use on 1DA series, 540ESC series sanders



587M



588M

Part Number	Diameter		Hex Size
	in	mm	
587M	2	50	1/4"
588M	3	75	1/4"

Fibre Backing Discs

Part No 586

For use on SPS10P series sanders

Packaged in cartons of 6

Qty 3 – 3" (75 mm)

Qty 3 – 4-1/2" (110 mm)



Backing Pads

For use on SPS10P series sanders



2344

Part Number	Thread	Diameter	
		in	mm
2344*	(3/8-24)	5	125
2364*	(5/8-11)	5	125

* Includes disc nut 563

7" (175 mm) or 9" (230 mm) Sanding Kits

For use on 1287, 1287L, 1290, 1290L & VS20 Series



545H

Part Number	Description
545 Standard Kit	
544	Disc holder
548	Backing disc
542	Retainer
524	Retaining nut
545H Heavy-Duty Kit	
544	Disc holder
548H	Heavy-duty backing disc
542	Retainer
524	Retaining nut



SAFETY PRECAUTION: Read and follow all safety and operating instructions.
WARNING: Face & eye protection must be worn while operating power tools, per ANSI B186.1

Orbital Sander Backing Pads

Sioux random orbital backing pads are medium density, urethane pads rated for speeds up to 13,000 rpm. The 5" pads are a 3/8" thick with low profile design, while the 6" pads are 5/8" thick with tapered profile for fine feathering in corners or around edges.

5/16" - 24 Spindle Thread



Part Number	Diameter		Backing	Profile	Style
	in	mm			
591	3	75	PSA ¹	Low	Vac/Non-Vac
591J	3	75	H & L ²	Low	Vac/Non-Vac
592	3.5	90	PSA ¹	Tapered	Vac/Non-Vac
592J	3.5	90	H & L ²	Tapered	Vac/Non-Vac
593	5	125	PSA ¹	Low	Non-Vac
593V	5	125	PSA ¹	Low	Vacuum
593J	5	125	H & L ²	Low	Non-Vac
593JV	5	125	H & L ¹	Low	Vacuum
593SV	5	125	PSA ¹	Low	Screen Vac
594	6	150	PSA ¹	Tapered	Non-Vac
594V	6	150	PSA ¹	Tapered	Vacuum
594J	6	150	H & L ²	Tapered	Non-Vac
594JV	6	150	H & L ²	Tapered	Vacuum
594SV	6	125	PSA ¹	Low	Screen Vac

¹ PSA - Vinyl face for pressure sensitive adhesive sanding discs

² H & L - Hook and loop face

Polishing Accessories



Part Number	Grit	Grit
846C*	Backing pad (Includes 524)	
1211B*	Wool polishing pad	
524*	Retaining nut	
847	Hook & loop backing pad	1238, 1238L
1220	Hook & loop polishing pad	1292, 1292L
843	Tie-on wool bonnet (pkg 10)	
1214	Polishing pad cleaning tool	

* Standard equipment on polishers

Vacuum Conversion Kits

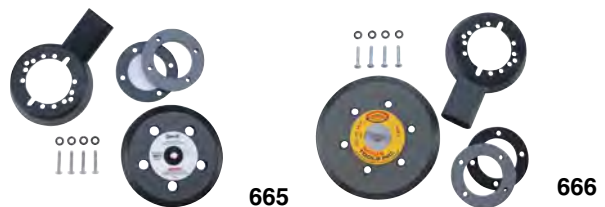

Part Number	For Use On
665	658, 690, 758, 790



SAFETY PRECAUTION: Read and follow all safety and operating instructions.
WARNING: Face & eye protection must be worn while operating power tools, per ANSI B186.1

Dustless Wet/Dry Vacuums



Dustless Wet/Dry Vacuum Sioux Model DVS-5

- Outperforms Traditional Shop Vacs
- Two Layers Of Filtration For A Dust-Free Environment
- Powerful 23,000 RPM, 11.5 Amp Electric Motor
- 16 Gallon Capacity
- Does Not Cough Dust When Vacuum Is Turned On
- Convenient Tool Storage Onboard Vacuum
- Filtration Down To .5 Microns
- Quiet Operation Only 81 dB(A)



Dustless HEPA Vacuum Sioux Model DVH-3

- HEPA Certified
- Filtration Down To .3 Microns
- 16 Gallon Capacity
- Designed For Extra Fine Dust
- Quiet Operation Only 81 dB(A)
- Great For Hexavalent Chromium Applications

Dustless Vacuum Shrouds

Random Orbital Sander Vacuum Shroud Sioux Models RO25VS-5 and RO25VS-6



- Fit RO25 Series Random Orbital Sanders
- Available For 5" Or 6" Sanders
- Captures 99% Of Airborne Dust
- Protects Workers From Harmful Airborne Dust
- Flexible And Transparent For Better Visibility
- Includes 6 Ft. Vacuum Hose

Part Number	Description
RO25VS-5	5" Vacuum Shroud
RO25VS-6	6" Vacuum Shroud

Drill and Rivet Shaver Vacuum Shroud Sioux Model DRVS150



- Can Be Used With Any Drill Or Rivet Shaver
- Suction Holds The Shroud In Place
- Great For Tight Spaces
- Can Be Used For Drilling Holes Up To 1 3/8" Diameter
- Captures 99% Of Airborne Dust
- Protects Workers From Harmful Airborne Dust
- Transparent For Better Visibility
- Includes 6 Ft. Vacuum Hose



SAFETY PRECAUTION: Read and follow all safety and operating instructions.
WARNING: Face & eye protection must be worn while operating power tools, per ANSI B186.1

Hose Cuff Adapter Set

- Adapts 1-1/2" hose to 1-1/4" hose
- Connector for 1-1/2" vacuum hose



MV-49

Pneumatic Tool Remote Start Adapter

- Lets You Start And Stop Your Pneumatic Tool And Vacuum In Synchronization
- Works With Any Pneumatic Tool
- Wireless Radio Operated
- Quick And Easy To Set Up



DVRS-PA

Electric Tool Remote Start Adapter

- Works With Any Electric Power Tool
- Works With Any Vacuum
- Recognizes Up To 16 Tool/Tool Pods
- Wireless Radio Operated
- Quick And Easy To Set Up
- Reduces Trip Hazard (Fewer Cords)



DVRS-EA

Vacuum Remote Start Adapter

- Allows the use of multiple tools off the same vacuum
- Can be used with any pneumatic tool or electric power tool



DVRS-VA

HEPA Filter

- Certified To Meet OSHA, EPA, & NIOSH Guidelines
- Captures Dust Down To .3 Microns
- Large Circumference For Increased Life
- Large Loose Plates For Increased Air Flow



MV-21

Micro Pre-filter Bag

- Disposable
- Eliminates The Need To Clean Filters
- Retains Strength When Wet
- Holds More Than 40 lbs of Dust And Debris
- Captures Extra Fine Dust Down To .5 Microns
- Extends The Life Of HEPA Filters
- Large Surface Area For Maximum Airflow



MV-52

Fabric Filter Set

- 2 Stage Inner And Outer Filter
- Machine Washable
- Stays Dry At All Times
- Clean Outer Filter Without Opening the Canister
- No Need To Change Filters When Changing From Wet To Dry Vacuuming
- Large Surface Area For Maximum Flow



MV-51

PERCUSSIVE



PERFORMANCE **WARNING**

PREVENT WHEEL SEPARATION

RECOMMENDED TIGHTENING TORQUE FOR DISC WHEEL MOUNTING NUTS IS 480-500 LB-FT. APPLIES TO BALL BEAM AND HUB-PILOT MOUNTING SYSTEMS WITH 3/4-16 OR M12 X 1.5 STUDS FOR ALUMINUM AND STEEL WHEELS. CHECK NUTS FREQUENTLY (50-100 MILES AFTER INITIAL IN-SERVICE DATE AND AT INTERVALS NOT TO EXCEED 25,000 MILES) AND TIGHTEN TO MAINTAIN RECOMMENDED TORQUE.

FAILURE TO HEED THIS WARNING CAN RESULT IN PROPERTY DAMAGE, SERIOUS INJURY OR DEATH.

Index

Scalers	62 – 63
Hammers	63
Percussive Accessories	64 – 66

PERCUSSIVE

Hammering Home A Point

Percussive tools, such as hammers, chippers and scalers are commonly used in very abusive environments found in industries such as foundry and construction. Sioux Tools offers a variety of sizes, capacities and accessories built durable to ensure long life under tough operating conditions. We build them to work hard on the job, but not on you!

Industrial Tools

Sioux offers powerful hammers that deliver up to 2,500 blows per minute (bpm), with steel rivet capacities of 5/32" (4 mm) to 1/4" (6.4 mm) and stroke lengths from 2" (50 mm) to 4" (100 mm).

Percussive Safety

Never operate a hammer without proper retainer in place. Always disconnect air line before changing chisels. Face and eye protection must be worn while operating tools. All chisels, rivet sets and other accessories should be checked for cracks, excessive wear, or other physical damage before each use. Accessories that show damage should be replaced immediately.

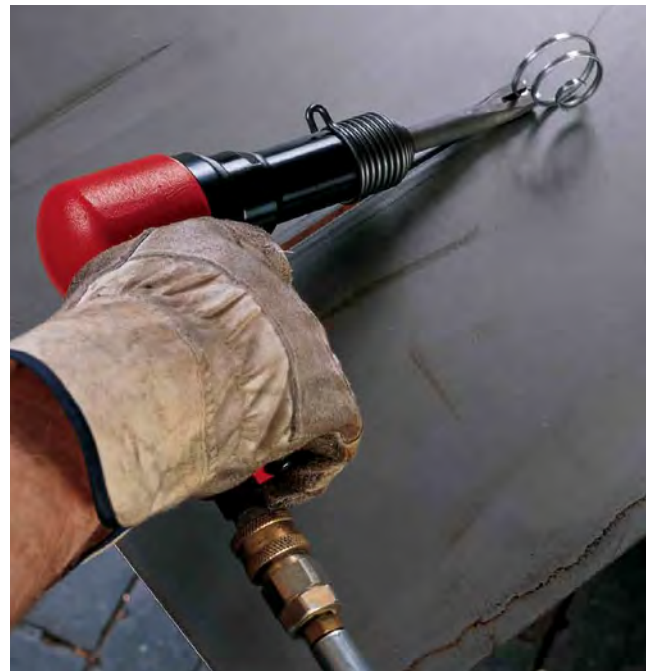

SQUARE SHANK SCALERS

SC41011AL-C



SC41011AU-N5



Performance:

Stroke: 1.1" (28 mm)
 Bore: 1.0" (25 mm)
 Blows per Minute: 4600

Features:

Lever and Push/Pull Start
 Quick Release Retainer
 Adjustable Needle Length

SC4 series scalers accept notched, square shank chisels and accessories. Each can be quickly converted between chisel and needle styles.



Square Shank



Square Shank Scalars

Model Number	Stroke Length		Bore Diameter		Blows per Minute	Weight		Length		Side To Center		Air Consumption	
	in	mm	in	mm		lb	kg	in	mm	in	mm	cfm	l/s
Chisel Scaler – Lever Throttle													
SC41011AL-C	1.1	28	1.0	25	4600	4.6	2.1	10.5	263	0.9	23	12.0	6
Chisel Scaler – Push/Pull Throttle													
SC41011AU-C	1.1	28	1.0	25	4600	4.6	2.1	12.0	300	0.9	23	12.0	6
Needle Scaler – Lever Throttle													
SC41011AL-N5	1.1	28	1.0	25	4600	6.3	2.9	15.3	383	1.0	25	12.0	6
Needle Scaler – Push/Pull Throttle													
SC41011AU-N5	1.1	28	1.0	25	4600	6.3	2.9	16.8	420	1.0	25	12.0	6

General:

Air Inlet Size: 1/4" NPT • Recommended Hose Size: 3/8" (10 mm) • Performance rated @ 90 psig (6.2 bar) air pressure

Standard Equipment:

Parts List • Safety and Instruction Manual • 7" flat chisel (chisel scalars) • 5" scaler needles (needle scalars)

Accessories:

Scaler Accessories, see pages 64 – 66

OCTAGON SHANK SCALERS

SC80910AL-C



SC80910AL-N5



Performance:

Stroke: 1.0" (25 mm)
 Bore: 15/16" (23 mm)
 Blows per Minute: 4300

Features:

Lever Throttle
 Quick Release Retainer
 Adjustable Needle Length

SC8 series scalars accept notched, octagon shank chisels and accessories. Each can be quickly converted between chisel and needle styles.



Octagon Shank



Octagon Shank Scalars

Model Number	Stroke Length		Bore Diameter		Blows per Minute	Weight		Length		Side To Center		Air Consumption	
	in	mm	in	mm		lb	kg	in	mm	in	mm	cfm	l/s
Chisel Scaler – Octagon Shank – Lever Throttle													
SC80910AL-C	1.0	25	15/16	23	4300	4.0	1.7	15.0	375	0.8	20	12.0	6
Needle Scaler – Octagon Shank – Lever Throttle													
SC80910AL-N5	1.0	25	15/16	23	4300	6.2	2.7	17.0	425	0.9	23	12.0	6

General:

Air Inlet Size: 1/4" NPT • Recommended Hose Size: 3/8" (10 mm) • Performance rated @ 90 psig (6.2 bar) air pressure

Standard Equipment:

Parts List • Safety and Instruction Manual • 7" flat chisel (chisel scalars) • 5" scaler needles (needle scalars)

Accessories:

Scaler Accessories, see pages 64 – 66

SC4 Scaler Kit

Part No. SC41011AL-K

- SC4 Lever Needle Scaler
- Additional Set of Needles
- 5/8" x 7" Flat Chisel
- 1-3/8" x 7" Flat Chisel
- 1-3/8" x 7" Spoon Chisel
- Custom Carrying Case



SC8 Scaler Kit

Part No. SC80910AL-K

- SC8 Needle Scaler
- Additional Set of Needles
- 5/8" x 7" Flat Chisel
- 1-3/8" x 7" Flat Chisel
- 1-3/8" x 7" Spoon Chisel
- Custom Carrying Case



SAFETY PRECAUTION: Read and follow all safety and operating instructions.
WARNING: Face & eye protection must be worn while operating power tools, per ANSI B186.1

Performance:

Stroke: 13/16" (21 mm)
 Bore: 1.0" (25 mm)
 Blows per Minute: 4000 – 5200

Features:

Removable Side Handle (SC3 series)
 Lever Operated Handle
 Rugged Steel Body

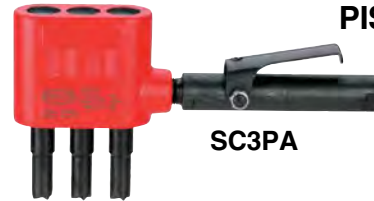

PISTON SCALERS

SC3PA



Piston Scalers

Model Number	Stroke Length		Bore Diameter		Blows per Minute	Weight		Length		Side to Center		Air Consumption Free Speed		Piston Type
	in	mm	in	mm		lb	kg	in	mm	in	mm	cfm	l/s	
Triple Piston Scaler														
SC3PA	13/16	21	1.0	25	5200	8.3	3.8	11.0	280	7/8	22	15	7	Steel
SC3PA-C	13/16	21	1.0	25	5200	8.3	3.8	11.0	280	7/8	22	15	7	Carbide Tipped

General: Air Inlet Size: 1/4" NPT • Recommended Hose Size: 3/8" (10 mm) • Performance rated @ 90 psig (6.2 bar) air pressure

Standard Equipment: Parts List • Safety and Instruction Manual

Accessories: Scaler Accessories, see pages 64 – 66

Replacement Pistons

Part Number	Description
2387	Standard Steel Piston
2388	Standard Steel Piston (2" Longer Than Standard)
2389	Carbide Tipped Piston (Chisel Point)
2390	Carbide Tipped Piston (Star Point)
2391	Solid Carbide Piston (Chisel Point)
2392	Solid Carbide Piston (Star Point)

Performance:

Rivet Capacity: 5/32" (4.0 mm) – 1/4" (6.4 mm)
 Stroke: 2.0" (50 mm) – 4.0" (100 mm)
 Bore: 0.6" (15 mm)

Features:

Pistol Grip
 Teasing Throttle Trigger Start
 Accepts .401 Parker Taper Rivet Sets and Chisels



HAMMERS

270A

270A-4

Hammers

Model Number	Steel Rivet Capacity		Stroke Length		Bore Diameter		Blows per Minute	Weight		Length		Side To Center		Air Consumption	
	in	mm	in	mm	in	mm		lb	kg	in	mm	in	mm	cfm	l/s
270A-2	5/32	4.0	2.0	50	0.6	15	2500	3.0	1.4	5.8	147	1.1	28	8.0	4
270A	3/16	4.8	3.0	75	0.6	15	2000	3.2	1.5	6.8	173	1.1	28	8.0	4
270A-4	1/4	6.4	4.0	100	0.6	15	1700	3.5	1.6	7.8	198	1.1	28	8.0	4

General: Air Inlet Size: 1/4" NPT • Recommended Hose Size: 3/8" (10 mm) • Performance rated @ 90 psig (6.2 bar) air pressure

Standard Equipment: Parts List • Safety and Instruction Manual • Beehive Retainer

Accessories: Hammer Accessories, see pages 64 – 66

Performance:

Stroke: 2.0" (50 mm) – 4.0" (100 mm)
 Bore: 1-1/8" (29 mm)

Features:

Round Front End Bushing or Hex Front End Bushing



CH43A-R



Four Bolt Chipping Hammers

Model Number	Bore		Stroke		Blows per Minute	Weight		Length		Side To Center		Air Consumption	
	in	mm	in	mm		lb	kg	in	mm	in	mm	cfm	l/s
Four Bolt Chipping Hammer – Round Front End Bushing													
CH42A-R	1-1/8	29	2.0	50	2100	18	8.0	16.0	405	1-5/8	41	33	15.6
CH43A-R	1-1/8	29	3.0	75	1650	19	8.6	17.0	430	1-5/8	41	34	16.0
CH44A-R	1-1/8	29	4.0	100	1375	20	9.0	18.0	455	1-5/8	41	35	16.5
Four Bolt Chipping Hammer – Hex Front End Bushing													
CH42A-H	1-1/8	29	2.0	50	2100	18	8.0	16.0	405	1-5/8	41	33	15.6
CH43A-H	1-1/8	29	3.0	75	1650	19	8.6	17.0	430	1-5/8	41	34	16.0
CH44A-H	1-1/8	29	4.0	100	1375	20	9.0	18.0	455	1-5/8	41	35	16.5

General: Air Inlet Size: 7/8"-24 NPT • Recommended Hose Size: 3/8" (10 mm) • Performance rated @ 90 psig (6.2 bar) air pressure

Standard Equipment: Parts List • Safety and Instruction Manual

Accessories: Four Bolt Chipper Accessories, see pages 64 – 66



SAFETY PRECAUTION: Read and follow all safety and operating instructions.
WARNING: Face & eye protection must be worn while operating power tools, per ANSI B186.1

Four Bolt Chipper Accessories

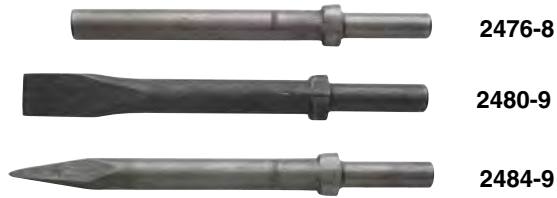

Part Number	For Use On
2476-8	Blank, 8", Oval Collar, Rd Shank
2477-8	Blank, 8", Oval Collar, Hex Shank
2478-8	Blank, 8", Rd Collar, Rd Shank
2479-8	Blank, 8", Rd Collar, Hex Shank
2476-11B	Blank, 11", Oval Collar, Rd Shank
2477-11	Blank, 11", Oval Collar, Hex Shank
2478-11	Blank, 11", RD Collar, Rd Shank
2479-11	Blank, 11", Rd Collar, Hex Shank
2480-9	Chisel, 9", Oval Collar, Rd Shank
2481-9	Chisel, 9", Oval Collar, Hex Shank
2482-9	Chisel, 9", Rd Collar, Rd Shank
2483-9	Chisel, 9", Rd Collar, Hex Shank
2480-12	Chisel, 12", Oval Collar, Rd Shank
2481-12	Chisel, 12", Oval Collar, Hex Shank
2482-12	Chisel, 12", Rd Collar, Rd Shank
2483-12	Chisel, 12", Rd Collar, Hex Shank
2480-18	Chisel, 18", Oval Collar, Rd Shank
2481-18	Chisel, 18", Oval Collar, Hex Shank
2482-18	Chisel, 18", Rd Collar, Rd Shank
2483-18	Chisel, 18", Rd Collar, Hex Shank
2480-24	Chisel, 24", Oval Collar, Rd Shank
2481-24	Chisel, 24", Oval Collar, Hex Shank
2484-9	Moil Point, 9", Oval Collar, Rd Shank
2485-9B	Moil Point, 9", Oval Collar, Hex Shank
2486-9	Moil Point, 9", Rd Collar, Rd Shank
2487-9	Moil Point, 9", Rd Collar, Hex Shank
2484-12	Moil Point, 12", Oval Collar, Rd Shank
2485-12	Moil Point, 12", Oval Collar, Hex Shank
2486-12	Moil Point, 12", Rd Collar, Rd Shank
2487-12	Moil Point, 12", Rd Collar, Hex Shank
2484-18	Moil Point, 18", Oval Collar, Rd Shank
2485-18	Moil Point, 18", Oval Collar, Hex Shank
2486-18	Moil Point, 18", Rd Collar, Rd Shank
2487-18	Moil Point, 18", Rd Collar, Hex Shank
2484-24B	Moil Point, 24", Oval Collar, Rd Shank
2485-24	Moil Point, 24", Oval Collar, Hex Shank
2486-24	Moil Point, 24", Rd Collar, Rd Shank

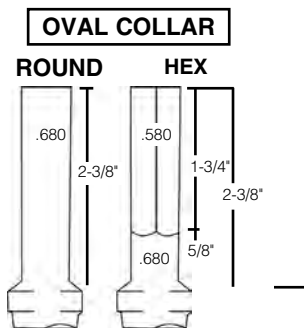

Four Bolt Chipper Accessories



Part Number	For Use On
2488-9	Chisel, 1-1/2" X 9", Oval Collar, Rd Shank
2489-9	Chisel, 1-1/2" X 9", Oval Collar, Hex Shank
2490-9	Chisel, 1-1/2" X 9", Rd Collar, Rd Shank
2491-9	Chisel, 1-1/2" X 9", Rd Collar, Hex Shank
2488-12	Chisel, 1-1/2" X 12", Oval Collar, Rd Shank
2489-12	Chisel, 1-1/2" X 12", Oval Collar, Hex Shank
2490-12	Chisel, 1-1/2" X 12", Rd Collar, Rd Shank
2491-12	Chisel, 1-1/2" X 12", Rd Collar, Hex Shank
2488-18	Chisel, 1-1/2" X 18", Oval Collar, Rd Shank
2489-18	Chisel, 1-1/2" X 18", Oval Collar, Hex Shank
2490-18	Chisel, 1-1/2" X 18", Rd Collar, Rd Shank
2491-18	Chisel, 1-1/2" X 18", Rd Collar, Hex Shank
2492-9	Chisel, 2" X 9", Oval Collar, Rd Shank
2493-9	Chisel, 2" X 9", Oval Collar, Hex Shank
2494-9	Chisel, 2" X 9", Rd Collar, Rd Shank
2495-9B	Chisel, 2" X 9", Rd Collar, Hex Shank
2492-12	Chisel, 2" X 12", Oval Collar, Rd Shank
2493-12	Chisel, 2" X 12", Oval Collar, Hex Shank
2494-12	Chisel, 2" X 12", Rd Collar, Rd Shank
2495-12	Chisel, 2" X 12", Rd Collar, Hex Shank
2492-18	Chisel, 2" X 18", Oval Collar, Rd Shank
2493-18	Chisel, 2" X 18", Oval Collar, Hex Shank
2494-18	Chisel, 2" X 18", Rd Collar, Rd Shank
2495-18	Chisel, 2" X 18", Rd Collar, Hex Shank
2496-9	Bushing Tool, Oval Collar, Rd Shank
2497-9	Bushing Tool, Oval Collar, Hex Shank
2498-9	Bushing Tool, Rd Collar, Rd Shank
2499-9	Bushing Tool, Rd Collar, Hex Shank
2470	Quick Change Retainer

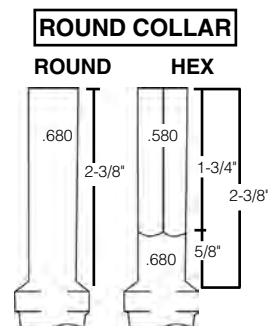

SAFETY PRECAUTION: Read and follow all safety and operating instructions.
WARNING: Face & eye protection must be worn while operating power tools, per ANSI B186.1

Scaler Accessories

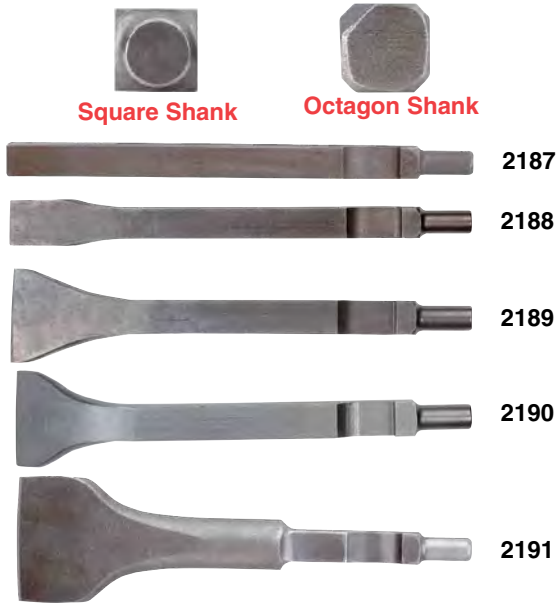

SC4 Chisels	SC8 Chisels	Description	Length		Width	
			in	mm	in	mm
2187	2287	Hardened Blank	7	175	5/8	16
2188	2288	Flat Chisel	7	175	5/8	16
2189	2289	Flat Chisel	7	175	1-3/8	35
2190	2290	Spoon Chisel	7	175	1-3/8	35
2191	2291	Flat Chisel	7	175	2	50
2192	2292	Flat Chisel	12	300	5/8	16
2193	2293	Flat Chisel	12	300	1-3/8	35
2194	2294	Spoon Chisel	12	300	1-3/8	35
2195	2295	Flat Chisel	12	300	2	50
2196	2296	Flat Chisel	18	450	5/8	16
2197	2297	Flat Chisel	18	450	1-3/8	35
2198	2298	Spoon Chisel	18	450	1-3/8	35
2199	2299	Flat Chisel	18	450	2	50

Scaler Kits



SC4 Scaler Kit

Part No. SC41011AL-K

- SC4 Lever Needle Scaler
- Additional Set of Needles
- 5/8" x 7" Flat Chisel
- 1-3/8" x 7" Flat Chisel
- 1-3/8" x 7" Spoon Chisel
- Custom Carrying Case

SC8 Scaler Kit

Part No. SC80910AL-K

- SC8 Needle Scaler
- Additional Set of Needles
- 5/8" x 7" Flat Chisel
- 1-3/8" x 7" Flat Chisel
- 1-3/8" x 7" Spoon Chisel
- Custom Carrying Case

Hammer Accessories

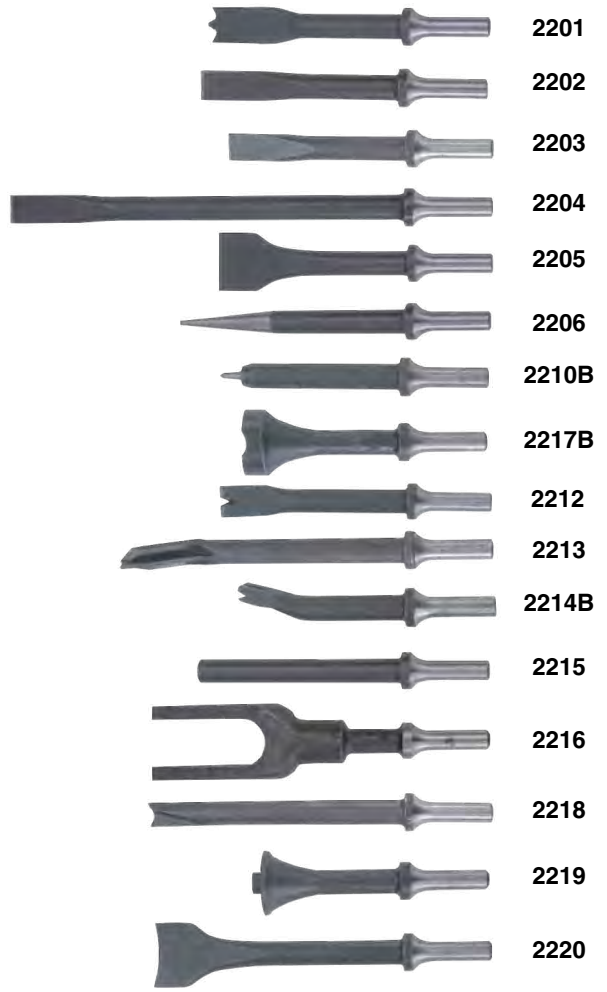

SC4 Chisels	Description	Width		Length	
		in	mm	in	mm
2201	Cutter	5/8	16	6	150
2202	Chisel	5/8	16	6	150
2203	Rivet Buster	5/8	16	5-1/2	140
2204	Expansion Chisel	5/8	16	11	280
2205	Scraper	1-1/4	30	6	150
2206	Punch			7	175
2210B	Punch			5	127
2217B	Rust Breaker			5-1/4	135
2212	Spot Weld Breaker			6	150
2213	Splitter			8	200
2214B	Edging Chisel			5	140
2215	Blank Chisel			6	150
2216	Fork Chisel			6-7/8	175
2218	Bushing Cutter			7	175
2219	Bushing Driver			4-1/2	115
2220	Bushing Chisel	1-5/8	40	7	175

Scaling Needles



2260

Part Number	Diameter	Length	Quantity	Used On
2260B	0.12"	5"	19	SC4, SC8 Scalers
2262	0.12"	7"	19	SC4, SC8 Scalers



SAFETY PRECAUTION: Read and follow all safety and operating instructions.
WARNING: Face & eye protection must be worn while operating power tools, per ANSI B186.1

Beehive Spring Retainers



2207



2208

Part Number	Description
2207	Chisel Retainer Spring
2208	Special Spring, use in place of 2207 with 2201, 2205, 2716, 2217, 2219 and 2220 Must use 2208 with 2239, 2244, 2245, 2246 and 2247

270 Rivet Sets

.401 Parker Taper Shank



2228



2238

Rivet Head Cupping	Rivet Diameter Size				
	3/32" Part No	1/8" Part No	5/32" Part No	3/16" Part No	1/4" Part No
Button Head	2228B	2229	2230B	2231	2244
Round Head	2232	2233	2234B	2235	2245
Brazier Head	2236	2237B	2238	2239	2246
Universal Head	2240	2241B	2242B	2243	2247

3-1/2" (90 mm) overall length

Rivet Set Profiles

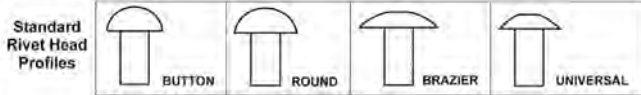

SPECIALTY



Index		Skin Clamp Runners	72
Routers	69	Saws & Cutoff Tools	73 – 74
Clinch Nut Tools	71	Nibblers & Shears	74
Tappers	72	Aerospace	76 – 77
Rivet Shavers	72	Specialty Accessories	78 – 79

SPECIALTY

Special Applications Require Special Tools

Sioux Tools has a superb selection of specialty tools designed for very specific applications, and as always, we manufacture the finest tools in the industry.

Routers

Sioux offers a selection of routers and laminate trimmers in 1.0 hp (0.75 kw) or 1.5 hp (1.1 kw) configurations. They feature lockoff lever, twist or finger throttles and come with a selection of different bases.

Tappers

Choose from pistol grip or inline configurations. The pistol grip offers chuck capacity from No. 10 thru 1/2" size.

Metal Working Tools

Nibbler and Shear

Our 1.0 hp (0.75 kw) nibbler and shear has the power for use on cold rolled sheet steel up to 18 gauge.

Shears

This versatile tool cuts 18 gauge steel and plastics up to 3/32" thick. It also makes straight or curve cuts clean and smooth.

Aircraft Specialty Tools

Sioux Tools offers several specialized tools for the aircraft industry such as Skin Clamp Runners, which are available in pistol grip or our exclusive Z-handle design. Rivet Shavers come in both pistol grip and inline configurations, with speeds up to 21,000 rpm.



Clinch Nut Tools

As manufacturing trends continue to evolve manufacturers are finding more and more uses for thin wall assembly applications. Sioux Tools has a selection of Clinch Nut tools that handle these unique fasteners with precision and ease, and our Rapid Reverse feature makes them the best Clinch Nut tool on the market today.

Air Powered Saws

Sioux Tools offers an outstanding and powerful Reciprocating Saw, offering variable speed control for precise cutting action in any application.



ROUTERS

SRT10S25N



SRT10S25B



SRT10S25BB



SRT10S25LT



Performance:

Power: 1.0 hp (0.75 kw)
 Speed: 18,000 rpm – 25,000 rpm
 Collet Size: 1/4" – (6 mm)

1 HP (0.75 kw) Routers

Features:

Lockoff Lever Throttle
 Front Exhaust
 Interchangeable Base
 Built-in Speed Control

Model Number	Collet Size	Free Speed		Weight		Height		Maximum Air Consumption		Sound Level
		rpm		lb	kg	in	mm	cfm	l/s	dB(A)
Template Nose										
SRT10S18N	1/4	18,000		2.1	0.95	9.0	230	30	14	78
SRT10S18M6N	6 mm	18,000		2.1	0.95	9.0	230	30	14	78
SRT10S25N	1/4	25,000		2.1	0.95	9.0	230	30	14	78
SRT10S25M6N	6 mm	25,000		2.1	0.95	9.0	230	30	14	78
3" Base										
SRT10S18B	1/4	18,000		2.1	0.95	9.0	230	30	14	78
SRT10S18M6B	6 mm	18,000		2.1	0.95	9.0	230	30	14	78
SRT10S18BB	1/4	18,000		2.6	1.15	8.3	210	30	14	78
SRT10S25B	1/4	25,000		2.1	0.95	9.0	230	30	14	78
SRT10S25M6B	6 mm	25,000		2.1	0.95	9.0	230	30	14	78
SRT10S25BB	1/4	25,000		2.6	1.15	8.3	210	30	14	78
Laminate Trimmer										
SRT10S18LT	1/4	18,000		2.9	1.30	9.3	235	30	14	78
SRT10S25LT	1/4	25,000		2.9	1.30	9.3	235	30	14	78

Template guides must be ordered separately

General: Air Inlet Size: 1/4" NPT • Recommended Hose Size: 3/8" (10 mm) • Performance rated @ 90 psig (6.2 bar) air pressure

Standard Equipment: Parts List • Safety and Instruction Manual • Base/Head Assembly, Collet, Collet Wrenches

Accessories: Router Accessories, see pages 78 – 79

Performance:

Power: 1.5 hp (1.2 kw)
 Speed: 20,000 rpm
 Collet Size: 1/4" – 1/2"

1.5 HP (1.12 kw) Routers

Features:

Twist and Finger Throttle
 4" (102 mm) or 6" (152 mm) Diameter Base
 Side Exhaust

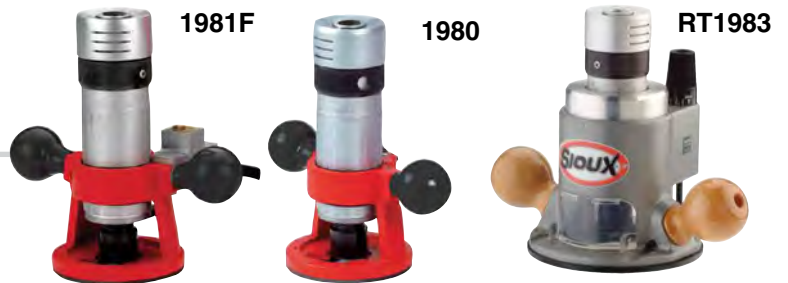

Model Number	Collet Size	Free Speed		Weight		Height		Base Diameter		Maximum Air Consumption		Sound Level
		rpm		lb	kg	in	mm	in	mm	cfm	l/s	dB(A)
Finger Throttle												
1981F	1/2"	20,000		6.0	2.7	9.8	248	4.0	102	38	18	85
Twist Throttle												
1980A	1/4"	20,000		4.5	2.0	7.6	193	4.0	102	38	18	85
1980	3/8"	20,000		4.5	2.0	7.6	193	4.0	102	38	18	85
RT1981	1/2"	20,000		4.5	2.0	7.6	193	4.0	102	38	18	85
1982A	1/4"	20,000		7.5	3.4	8.3	211	6.0	152	38	18	85
RT1982	3/8"	20,000		7.5	3.4	8.3	211	6.0	152	38	18	85
RT1983	1/2"	20,000		4.8	2.2	8.3	211	6.0	152	38	18	85

General: Air Inlet Size: 1/4" NPT • Recommended Hose Size: 3/8" (10 mm) • Performance rated @ 90 psig (6.2 bar) air pressure

Standard Equipment: Parts List • Safety and Instruction Manual • Base & Collet Wrenches

Accessories: Router Accessories, see pages 78 – 79



SAFETY PRECAUTION: Read and follow all safety and operating instructions.
WARNING: Face & eye protection must be worn while operating power tools, per ANSI B186.1

SPECIALTY

The Fastest Way Out of a Clinch

Sioux Tool's new rapid reverse Clinch Nut Tools are meeting the demand of today's manufacturing marketplace with versatility and simplicity. Clinch nuts, also known as captive nuts, provide a reliable means of securing assembly components in thin wall applications. These unique fasteners are inserted into predrilled holes in thin materials such as sheet metal, and with the aid of a Sioux Clinch Nut Tool, compress and expand to clamp the material. This process creates a strong, secure base with a male or female thread for assembling additional components.

Installing Clinch Nut Fasteners

When installing clinch nut fasteners, the key to achieving high productivity with accurate, repeatable results is matching the right tool and fastener to your application. The right combination of rundown speed and stall torque in conjunction with a quick reverse method for disengaging the tool, will provide the best results. The Sioux SCN series tools offer higher torque in a wide range of speeds so you can match the right tool to your application. Our powerful tools allow you to use faster rundown speeds while maintaining high torque output, plus our exclusive Rapid Reverse feature makes short work of direction changes ensuring fast disengagement from the fastener.

Reducing Physical Load

The ergonomic pistol housing with comfort rubber grip ensures operator comfort while maintaining superb balance and control. The powerful, precision motor ensures fast and consistent installation of fasteners in a variety of applications, and the wide selection of speeds and threads in both English and metric sizes make Sioux Tools your choice for all your clinch nut applications.

Clinch Nut Installation Procedure

Step 1 – Pre-drill hole for fastener.



Step 2 – Insert fastener.



Step 3 – Thread tool into fastener.



Step 4 – Run tool to collapse fastener.
Reverse tool to release.



Step 5 – Assemble.



SAFETY PRECAUTION: Read and follow all safety and operating instructions.
WARNING: Face & eye protection must be worn while operating power tools, per ANSI B186.1

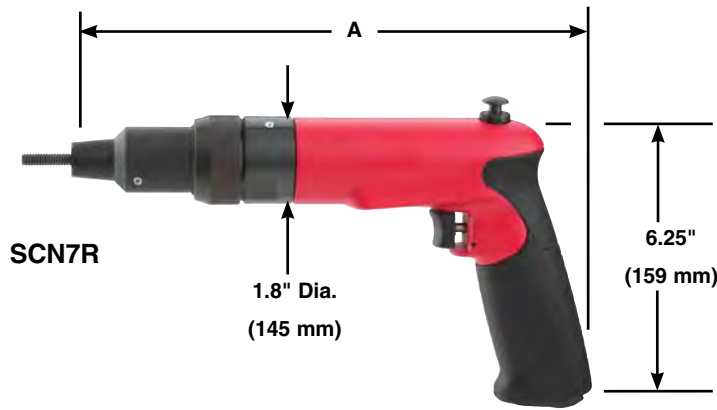

Performance:

Torque: 60 in. lb (6.5 Nm) – 400 in. lb (45 Nm)
 Speed: 300 rpm – 2500 rpm

Features:

Reversible
 Pistol Grip

1 HP (0.75 kw) Clinch Nut Tools



Model Number	Free Speed	Maximum Torque		Weight		"A" Dimension		Side To Center		Maximum Air Consumption		Sound Level
	rpm	in lb	Nm	lb	kg	in	mm	in	mm	cfm	l/s	dB(A)
Pistol Grip – Rapid Reverse – Power Units Specifications												
SCN3R	300	400	45.2	3.2	1.5	11.0	279	0.9	20	30	14	80
SCN5R	500	325	36.7	3.2	1.5	11.0	279	0.9	20	30	14	80
SCN7R	700	220	24.8	3.2	1.5	11.0	279	0.9	20	30	14	80
SCN12R	1200	145	16.4	3.2	1.5	11.0	279	0.9	20	30	14	80
SCN20R	2000	80	9.0	2.8	1.3	10.0	254	0.9	20	30	14	80
SCN25R	2500	60	6.5	2.8	1.3	10.0	254	0.9	20	30	14	80

Power units can be ordered separately using part number above. For ordering complete tools select the appropriate power unit from the chart above and head assembly from the chart below and combine their part numbers as shown in the following example: SCN3R420.

General:

Air Inlet Size: 1/4" NPT • Recommended Hose Size: 3/8" (10 mm) • Performance rated @ 90 psig (6.2 bar) air pressure

Standard Equipment:

Parts List • Safety and Instruction Manual • Comfort Grip

Accessories:

Clinch Nut Accessories, see pages 78 – 79

Clinch Nut (Female)



Thread Size	Order Number Suffix	
	Serrated Nose	Smooth Nose
#4-40	440	440S
M3 x 0.5	M305	M305S
#6-32	632	632S
#8-32	832	832S
M4 x 0.7	M407	M407S
#10-24	1024	1024S
#10-32	1032	1032S
M5 x 0.8	M508	M508S
1/4-20	420	420S
M6 x 1.0	M610	M610S
5/16-18	518	518S
M8 x 1.25	M8125	M8125S
3/8-16	616	616S
M10 x 1.5	M1015	M1015S

Clinch Stud (Male)

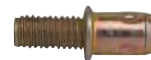

Thread Size	Order Number Suffix	
	Serrated Nose	Smooth Nose
#4-40	440F	440SF
M3 x 0.5	M305F	M305SF
#6-32	632F	632SF
#8-32	832F	832SF
M4 x 0.7	M407F	M407SF
#10-24	1024F	1024SF
#10-32	1032F	1032SF
M5 x 0.8	M508F	M508SF
1/4-20	420F	420SF
M6 x 1.0	M610F	M610SF
5/16-18	518F	518SF
M8 x 1.25	M8125F	M8125SF
3/8-16	616F	616SF
M10 x 1.5	M1015F	M1015SF

Head assemblies can be ordered separately by adding the prefix SCN to the above part number (example SCN-420).



SAFETY PRECAUTION: Read and follow all safety and operating instructions.
WARNING: Face & eye protection must be worn while operating power tools, per ANSI B186.1

TAPPERS

Performance:

Power: 1 hp (0.75 kw)
Torque: 145 in. lb (16 Nm) – 400 in. lb (45 Nm)
Speed: 300 rpm – 1200 rpm

Features:

Pistol Grip Handle
Rapid Reverse

Capacity:

1/4" in Steel
5/16" in Aluminum



Tappers

Model Number	Chuck Capacity		Maximum Torque		Free Speed	Weight		Length		Air Consumption		Sound Level
	in	mm	in lb	Nm	rpm	lb	kg	in	mm	cfm	l/s	dB(A)
1 hp (0.75 kw) – Pistol Grip – Trigger Start												
STP10P3C20	#10-5/16	5-8	400	45	300	2.9	1.3	7.3	185	30	14	80
STP10P3C32	1/4-1/2	6-13	400	45	300	2.9	1.3	7.3	185	30	14	80
1 hp (0.75 kw) – Inline – B12 Taper Spindle												
STP10S12B12			145	16	1200	2.5	1.2	9.5	240	30	14	78
STP10S7B12			220	25	700	2.5	1.2	9.5	240	30	14	78
STP10S5B12			325	37	500	2.5	1.2	9.5	240	30	14	78
STP10S3B12			400	45	300	2.5	1.2	9.5	240	30	14	78

General: Air Inlet Size: 1/4" NPT • Recommended Hose Size: 3/8" (10 mm) • Performance rated @ 90 psig (6.2 bar) air pressure

Standard Equipment: Parts List • Safety and Instruction Manual • Comfort Grip • Tapping Chuck (model STP10P3C series)

Accessories: Tapper Accessories, see pages 78 – 79

RIVET SHAVERS

Performance:

Power: 1 hp (0.75 kw)
Speed: 21,000 rpm

Features:

Pistol Grip & Inline



Rivet Shavers

Model Number	Cutter Diameter		Free Speed	Weight		Length		Side to Center		Maximum Air Consumption		Sound Level
	in	mm	rpm	lb	kg	in	mm	in	mm	cfm	l/s	dB(A)
1 hp (0.75 kw) – Pistol Grip – 1/4"-28 Internal Thread												
SRS10P21-5	5/16	8	21,000	2.7	1.2	8.0	205	0.9	23	25	12	80
SRS10P21-6	3/8	10	21,000	2.7	1.2	8.0	205	0.9	23	25	12	80
SRS10P21-7	7/16	11	21,000	2.7	1.2	8.0	205	0.9	23	25	12	80
SRS10P21-8	1/2	13	21,000	2.7	1.2	8.0	205	0.9	23	25	12	80
SRS10P21-9	9/16	14	21,000	2.7	1.2	8.0	205	0.9	23	25	12	80
SRS10P21-10	5/8	16	21,000	2.7	1.2	8.0	205	0.9	23	25	12	80
1 hp (0.75 kw) – Inline – 1/4"-28 Internal Thread												
SRS10S21-8	1/2	13	21,000	2.5	1.1	10.0	255	0.9	23	30	14	78

General: Air Inlet Size: 1/4" NPT • Recommended Hose Size: 3/8" (10 mm) • Performance rated @ 90 psig (6.2 bar) air pressure

Standard Equipment: Parts List • Safety and Instruction Manual • Skirt • Comfort Grip (Pistol Grip models)

Accessories: Rivet Shaver Accessories, see pages 78 – 79

SKIN CLAMP RUNNERS

Performance:

Speed: 2200 rpm - 2500 rpm

Features:

Pistol Grip and Z-Handle
1/2-12 Point Internal, 9/16-6 Point External Hex



Skin Clamp Runners

Model Number	Free Speed	Weight		Length		Side to Center		Air Consumption		Sound Level
	rpm	lb	kg	in	mm	in	mm	cfm	l/s	dB(A)
Z-Handle										
2S2300SR	2200	2.6	1.2	5.7	145	0.9	23	16	8	75
Pistol Grip										
SSR6P-25	2500	2.7	1.2	9.2	234	0.9	23	30	14	78

General: Air Inlet Size: 1/4" NPT • Recommended Hose Size: 3/8" (10 mm) • Performance rated @ 90 psig (6.2 bar) air pressure

Standard Equipment: Parts List • Safety and Instruction Manual • Comfort Grip (Pistol Grip models)

Accessories: Skin Clamp Runner Accessories, see pages 78 – 79



SAFETY PRECAUTION: Read and follow all safety and operating instructions.
WARNING: Face & eye protection must be worn while operating power tools, per ANSI B186.1

RECIPROCATING SAW

Performance:

Power: 1.0 hp (0.75 kw)
 Strokes per Minute: 1800
 Stroke Length: 0.6" (15 mm)

Features:

Lockoff Trigger Start
 Variable Speed
 Swivel Air Inlet



1300

Reciprocating Saw

Model Number	Stroke Length		Strokes per Minute	Power		Weight		Length		Air Consumption		Sound Level
	in	mm		hp	kw	lb	kg	in	mm	cfm	l/s	dB(A)
1300	0.6	15	1800	1.0	0.7	7.8	3.5	17.2	437	35	17	86

General:

Air Inlet Size: 1/4" NPT • Recommended Hose Size: 3/8" (10 mm) • Performance rated @ 90 psig (6.2 bar) air pressure

Standard Equipment:

Parts List • Safety and Instruction Manual • Swivel Air Inlet • 2 Blades • Protective Boot

Accessories:

Reciprocating Saw Accessories, see pages 78 – 79

Performance:

Free Speed: 10,000 rpm
 Stroke Length: .375" (10 mm)
 Cuts up to 1/8" (3 mm) mild steel

Features:

Lock-off lever start
 Low vibration
 360° Adjustable Exhaust Deflector
 Dual chuck accepts: 0.035" standard air saw blades AND 6" long reciprocating saw blades

RECIPROCATING SAW



RS10K

Reciprocating Saw

Model Number	Stroke Length		Strokes per Minute	Weight		Length		Air Consumption		Sound Level
	in	mm		lb	kg	in	mm	cfm	l/s	dB(A)
RS10K	0.375	10	10,000	1.53	0.69	9.4	238.76	1.0	0.5	87.1

General:

Air Inlet Size: 1/4" NPT • Recommended Hose Size: 3/8" (10 mm) • Performance rated @ 90 psig (6.2 bar) air pressure

Standard Equipment:

Parts List • Safety and Instruction Manual • Swivel Air Inlet • 2 Blades • Protective Boot

Accessories:

Reciprocating Saw Accessories, see pages 78 – 79

Performance:

Power: 1.0 hp (0.75 kw)
 Free Speed: 18,000 rpm – 25,000 rpm

Features:

Inline
 Lockoff Lever Start
 Front or Rear Exhaust

CUTOFF TOOL (TYPE 1)



SCO10S253F



Cutoff Tool

Model Number	Blade Diameter		Depth of Cut		Free Speed	Weight		Length		Air Consumption		Sound Level	Exhaust
	in	mm	in	mm		rpm	lb	kg	in	mm	cfm	l/s	
1 hp (0.75 kw) – Cutoff Tool – Inline – Lockoff lever Start													
SCO10S184F	4.0	100	1.1	28	18,000	2	0.9	8.3	210	30	14	89.1	Front
SCO10S184R	4.0	100	1.1	28	18,000	2	0.9	8.3	210	30	14	87.8	Rear
SCO10S204F	4.0	100	1.1	28	20,000	2	0.9	8.3	210	30	14	90.3	Front
SCO10S204R	4.0	100	1.1	28	20,000	2	0.9	8.3	210	30	14	91.6	Rear
SCO10S253F	3.0	76	1.0	25	25,000	2	0.9	8.3	210	30	14	89.0	Front
SCO10S253R	3.0	76	1.0	25	25,000	2	0.9	8.3	210	30	14	87.8	Rear

General:

Air Inlet Size: 1/4" NPT • Recommended Hose Size: 3/8" (10 mm) • Performance rated @ 90 psig (6.2 bar) air pressure

Standard Equipment:

Parts List • Safety and Instruction Manual • 1 Blade • Spindle Wrenches & Guard

Accessories:

Panel and Cutoff Saw Accessories, see pages 78 – 79



SAFETY PRECAUTION: Read and follow all safety and operating instructions.
WARNING: Face & eye protection must be worn while operating power tools, per ANSI B186.1

ANGLE CUTOFF TOOLS (TYPE 1)

Features:

- Heavy duty spiral bevel gearing for durability and smooth operation
- 4 position indexable angle head
- 360 degree rotatable guard
- Grease zerk in gear case



SCO10A106



Angle Cutoff Tool

Model Number	Blade Diameter		Depth of Cut		Free Speed	Weight		Length		Air Consumption		Sound Level	Spindle Thread	Exhaust
	in	mm	in	mm	rpm	lb	kg	in	mm	cfm	l/s	dB(A)		
SCO10A106	6.0	150	2.0	51	10,000	3.7	1.7	8.75	220	35	16.5	91.2	5/8"-11	Rear
SCO10A125	5.0	125	1.5	38	12,000	3.5	1.6	8.75	220	35	16.5	87.3	5/8"-11	Rear

General:
Air Inlet Size: 1/4" NPT • Recommended Hose Size: 3/8" (10 mm) • Performance rated @ 90 psig (6.2 bar) air pressure

Standard Equipment:
Parts List • Safety and Instruction Manual • 1 Blade • Spindle Wrenches & Guard

Accessories:
Angle Cutoff Tool Accessories, see page 77 – 78

NIBBLER

Performance:

Power: 1.0 hp (0.75 kw)
Capacity: 18 Gauge Cold Rolled Steel



SNH10S18

Nibbler

Model Number	Capacity (Cold Rolled Steel)	Power		Weight		Length		Side to Center		Maximum Air Consumption		Sound Level
	in	hp	kw	lb	kg	in	mm	in	mm	cfm	l/s	dB(A)
SNH10S18 ¹	18 Ga	1.0	0.75	2.65	1.2	8.5	215	.9	32	30	14	82.4

¹ Not CE Certified
General:
Air Inlet Size: 1/4" NPT • Recommended Hose Size: 3/8" (10 mm) • Performance rated @ 90 psig (6.2 bar) air pressure

Standard Equipment:
Parts List • Safety and Instruction Manual

Accessories:
Nibbler Accessories, see pages 78 – 79

SHEARS

Performance:

Power: 1.0 hp (0.75 kw)
Capacity: 18 Gauge Cold Rolled Steel



SSH10S18

SSH10P18

Shears

Model Number	Capacity (Cold Rolled Steel)	Power		Weight		Length		Side to Center		Maximum Air Consumption		Sound Level
	in	hp	kw	lb	kg	in	mm	in	mm	cfm	l/s	dB(A)
SSH10S18 ¹	18 Ga	1.0	0.75	2.75	1.25	11.0	280	.9	32	30	14	79.4
SSH10P18	18 Ga.	1.0	0.75	2.9	1.3	10.0	255	0.9	22	30	14	85.1

¹ Not CE Certified
General:
Air Inlet Size: 1/4" NPT • Recommended Hose Size: 3/8" (10 mm) • Performance rated @ 90 psig (6.2 bar) air pressure

Standard Equipment:
Parts List • Safety and Instruction Manual • Comfort Grip (SSH10P18)

Accessories:
Shears Accessories, see pages 78 – 79



SAFETY PRECAUTION: Read and follow all safety and operating instructions.
WARNING: Face & eye protection must be worn while operating power tools, per ANSI B186.1

SPECIALTY

Compression Riveters

Principles of Operation

Air powered compression riveters deliver a squeezing action, which drives the rivet by “flowing” the rivet metal with compressed forces. Squeezing action is obtained by coupling an air cylinder and piston to a wedge or cam, thus multiplying the original force to extreme ratios. High compressive forces are obtained from a relatively compact unit having small diameter cylinders and using very little compressed air.

The advantage of squeeze riveting is simple sounds of air exhaust and forward piston movement developing tremendous pressures being exerted at the work point.

Optimum control may be obtained in compression riveting. The rivet head is formed by a steady, uniform squeeze action. The set plunger and dolly are an integral part of the squeezer itself.

Length of the return stroke may be adjusted that the plunger itself does not have to travel its full length.

Consistently applied pressure makes for a better appearance of the finished product as well as giving the ultimate in structural efficiency.

Classification of Squeezers:

Alligator: The squeezing action of the jaws are similar to the movement of an Alligators jaws.

‘C’ Type: The rivet is squeezed between the two ends of the ‘C’.

Type of Rivet:

Rivet material.

Rivet body diameter.

Rivet length before and after compression.

Force required to compress rivet.

Riveter Selection Guide:

What material is the rivet made from?

What size is the rivet?

What is the form of the head?

What components are being assembled?

Are there any clearance problems?

Is Alligator or ‘C’ type yoke required?

How is the application being done now?

Are there any special considerations?

COMPRESSION RIVETERS

For maximum power the combined length of the two rivet sets must be of the correct length.

Determine the correct lengths as follows:

1) When two cupped rivet sets are used:

The length of the body dimensions of the two rivet sets (A1, A2) should equal the closed height dimension of the yoke (H) minus the total thickness of material being riveted together.

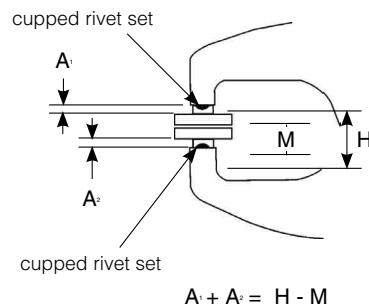

2) When one cupped set and one flush set are used:

The length of the body dimensions of the two rivet sets (A1, A2) should equal the closed height dimension of the yoke H minus the total thickness of material being riveted (M) and the height of the finished rivet head (Z) compressed by the flush set (A).

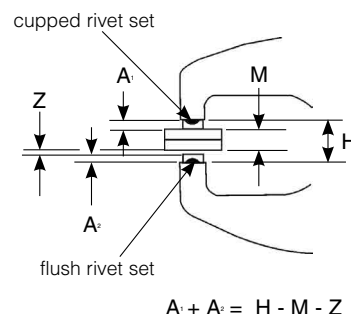

3) When two flush sets are used:

The length of the body dimensions of the two rivet sets (A1, A2) should equal the closed height dimension of the yoke (H) minus the overall length of the rivet (M) after it is compressed.

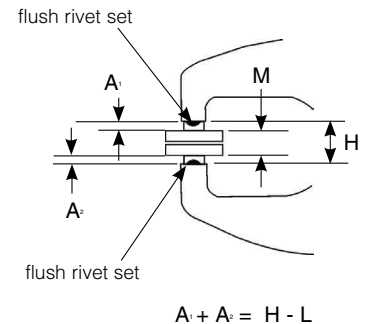

If necessary, select rivet sets a little short and shim to the correct length using spacer shims.

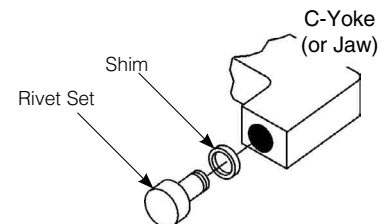

SAFETY PRECAUTION: Read and follow all safety and operating instructions.
WARNING: Face & eye protection must be worn while operating power tools, per ANSI B186.1

COMPRESSION RIVETERS

Single, Tandem, and Triple Cylinder Options

Riveting Capacity:

1/8" (3 mm) (Single Cylinder)

3/16" (5 mm) (Tandem Cylinder)

1/4" (6 mm) (Triple Cylinder)

Safety Throttle



SZE A5030



SZE A7030



SZE A9030

Compression Riveters

Model Number	Rivet Set Shank Diameter		Cap Cold Rivet Diameter				Standard Alligator Yoke Dimension				Max Force at 90 psi		Moving Jaw				Net Weight w/ Yoke		Overall Length	
			Steel		Alum		Reach		Closed Ht				Max Travel		Stroke at Max Force					
	in	mm	in	mm	in	mm	in	mm	in	mm	in	mm	in	mm	in	mm	lb	kg	in	mm
CR-1 – Single Cylinder																				
SZE A5000	NA	NA	3/32	2	1/8	3	NA	NA	NA	NA	3000	13.4	5/8	16	final 1/16	2	2-1/4	1.0	7-11/16	195
SZE A5015	3/16	5	3/32	2	1/8	3	1-1/2	38	7/8	22	3000	13.4	5/8	16	final 1/16	2	3.75	1.7	9-3/16	233
SZE A5022	3/16	5	3/32	2	3/32	2	2-1/4	57	7/8	22	2200	9.8	7/8	22	final 3/32	2	4.25	1.9	10-1/8	257
SZE A5030	3/16	5	3/32	2	3/32	2	3	76	7/8	22	1800	8.0	1-1/4	32	final 1/8	3	4.75	2.2	10-7/8	276
CR-1 – Tandem Cylinder																				
SZE A7000	NA	NA	5/32	4	3/16	5	NA	NA	NA	NA	6000	26.7	5/8	16	final 1/16	2	4	1.8	10-1/2	267
SZE A7015	3/16	5	5/32	4	3/16	5	1-1/2	38	7/8	22	6000	26.7	5/8	16	final 1/16	2	5.5	2.5	12	305
SZE A7022	3/16	5	1/8	3	5/32	4	2-1/4	57	7/8	22	4300	19.1	7/8	22	final 3/32	2	6	2.7	13	330
SZE A7030	3/16	5	3/32	2	1/8	3	3	76	7/8	22	3400	15.1	1-1/4	32	final 1/8	3	6.25	2.8	13.75	349
CR-1 – Triple Cylinder																				
SZE A9000	NA	NA	3/16	5	1/4	6	NA	NA	NA	NA	9000	40.1	5/8	16	final 1/16	2	5.5	2.5	14.5	368
SZE A9015	3/16	5	3/16	5	1/4	6	1-1/2	38	7/8	22	9000	40.1	5/8	16	final 1/16	2	7	3.2	16	406
SZE A9022	3/16	5	5/32	4	3/16	5	2-1/4	57	7/8	22	7000	31.2	7/8	22	final 3/32	2	7.5	93.4	16.75	426
SZE A9030	3/16	5	5/32	4	3/16	5	3	76	7/8	22	5200	23.1	1-1/4	32	final 1/8	3	8	3.6	17.5	445

General:

Air Inlet Size: 1/4" NPT • Recommended Hose Size: 3/8" (10 mm) • Performance rated @ 90 psig (6.2 bar) air pressure

Standard Equipment:

Parts List • Safety and Instruction Manual • Safety throttle action

Alligator Yoke Nomenclature

- A** Reach
- B** Closed Height
- C** Total
- E** Gap
- H** Lowest Offset
- N** Depth from centerline to Stationary Jaw Gap
- P** Depth from centerline to Stationary Jaw set hole surface

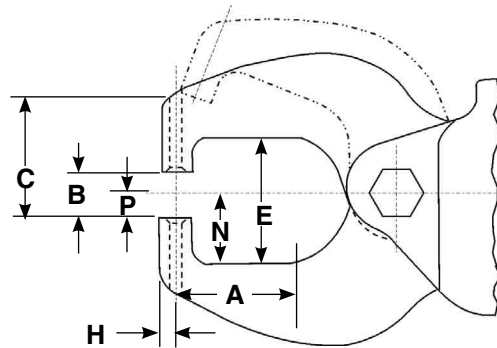

A		B		C		E		H		N		P	
in	mm	in	mm	in	mm	in	mm	in	mm	in	mm	in	mm
1-1/2	38	7/8	22	1-1/2	38	1-5/8	41	7/32	6	1.0	1	5/8	16
2-1/4	57	7/8	22	1-7/8	48	2-1/8	54	7/32	6	1-1/4	32	5/8	16
3.0	76	7/8	22	2-1/8	54	2-1/8	54	7/32	6	1-1/4	32	5/8	16



SAFETY PRECAUTION: Read and follow all safety and operating instructions.
WARNING: Face & eye protection must be worn while operating power tools, per ANSI B186.1

COMPRESSION RIVETERS

Single, Tandem, and Triple Cylinder Options
 Riveting Capacity:
 1/8" (3 mm) (Single Cylinder)
 3/16" (5 mm) (Tandem Cylinder)
 1/4" (6 mm) (Triple Cylinder)
 Safety Throttle



SZE3015



SZE6015



SZE8015

Compression Riveters

Model Number	Rivet Set Shank Diameter		Cap Cold Rivet Diameter				Standard "C" Yoke Dimension				Closed Height		Max Travel		Max Force at 90 psi		Stroke at Max Force		Net Weight w/ Yoke		Overall Length	
			Steel		Alum		Reach		Gap													
	in	mm	in	mm	in	mm	in	mm	in	mm	in	mm	in	mm	lb	kN	in	mm	lb	kg	in	mm
CR-1 – Single Cylinder																						
SZE3000	N/A	N/A	3/32	2	1/8	3	N/A	N/A	N/A	N/A	N/A	N/A	9/16	14	3000	13.4	f-1/16	2	3-1/2	1.6	8-1/2	216
SZE3015	3/16	5	3/32	2	1/8	3	1-1/2	38	1-1/4	32	11/16	78	9/16	14	3000	13.4	f-1/16	2	4-1/2	2.0	10-1/4	262
CR-1 – Tandem Cylinder																						
SZE6000	N/A	N/A	5/32	4	3/16	5	N/A	N/A	N/A	N/A	N/A	N/A	9/16	14	6000	26.7	f-1/16	2	4-1/2	2.0	11-1/4	287
SZE6015	3/16	5	5/32	4	3/16	5	1-1/2	38	1-1/4	32	11/16	78	9/16	14	6000	26.7	f-1/16	2	5-1/2	2.5	14	356
CR-1 – Triple Cylinder																						
SZE8000	N/A	N/A	5/32	4	1/4	6	N/A	N/A	N/A	N/A	N/A	N/A	9/16	14	9000	40.1	f-1/16	2	7-1/2	3.4	16	406
SZE8015	3/16	5	3/16	5	1/4	6	1-1/2	38	1-1/4	32	11/16	78	9/16	14	9000	40.1	f-1/16	2	8-1/2	3.9	18-3/4	476

Due to a variety of jobs and applications, Squeeze Riveters are not supplied with rivet sets. Please contact Sioux Tools, Inc. or your local distributor for rivet set information.

General:

Air Inlet Size: 1/4" NPT • Recommended Hose Size: 3/8" (10 mm) • Performance rated @ 90 psig (6.2 bar) air pressure

Standard Equipment:

Parts List • Safety and Instruction Manual • Safety throttle action

C-Yoke Nomenclature

- A Reach
- B Gap
- C Height from yoke hole to center to top of yoke gap
- D Bottom set hole diameter CR-1 or CR-2
- E Top set hole diameter CR-1 or CR-2
- F Width of yoke set hole center to top of yoke
- G Thickness of yoke
- H Height of yoke from bolt hole center to top of yoke
- I Radius from set hole center

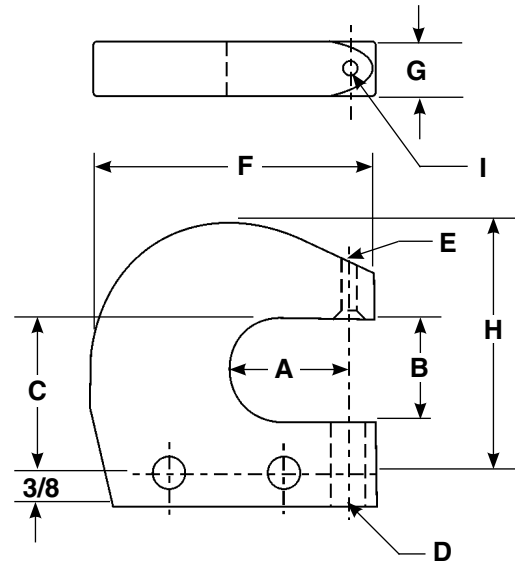

A		B		C		D		E		F		G		H		I	
in	mm	in	mm	in	mm	in	mm	in	mm	in	mm	in	mm	in	mm	in	mm
1-1/2	38	1-1/4	32	1-7/8	48	3/8	10	3/16	5	2-7/8	73	9/16	14	3.0	76	1/4	6
						7/16	11	1/4	6								



SAFETY PRECAUTION: Read and follow all safety and operating instructions.
WARNING: Face & eye protection must be worn while operating power tools, per ANSI B186.1

Rivet Shaver Skirts



Part Number	Cutter Diameter	
	in	mm
2925-5	5/16	8
2925-6	3/8	10
2925-7	7/16	11
2925-8	1/2	13
2925-9	9/16	14
2925-10	5/8	16

Collets



Collet Type	Part Number	Capacity	For Use On
Sioux	44440	1/4"	1971HP series
Sioux	66038	6 mm	1971HP series
100 Series	21126	1/4"	1980, 1981
100 Series	21125	3/8"	1982, 1983



Collet Type	Collets
21095	#10 - 5/16"
21139	1/4" - 1/2"

Support Handle

Part No. 2355B



Signature Series Support Handle

Part No. SPSDR-14A



Collet Chuck Assemblies

Sioux Style Collets



Collet Chuck Assemblies	Sioux Collet Chuck				
	1/8"	3 mm	3/16"	1/4"	6 mm
Chuck Assembly	43342	68617	43341	43340	68618
Collet Body	21096	21096	21096	21096	21096
Collet Insert	44522	66037	44523	44440	66038
Collet Nose	N/A	N/A	N/A	N/A	N/A
Collet Nut	21097	21097	21097	21097	21097

200 Series Heavy Duty Double Tapered Collet

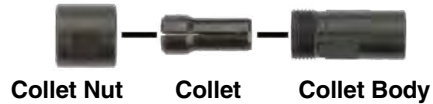

Part Number	Description
74071	Collet Nut
74072	Collet (1/8")
74073	Collet (3/16")
74074	Collet (1/4")
68030	Collet (3/8")
74075	Collet (3 mm)
74076	Collet (6 mm)
68056	Collet (8 mm)
77057	Collet Body SDG Series
74070	Collet Body (1 HP)

300 Series Heavy Duty Double Tapered Collet



Part Number	Description
74128	Collet Nut
74124	Collet (3/32")
74121	Collet (1/8")
74120	Collet (1/4")
74122	Collet (3 mm)
74123	Collet (6 mm)
77505	Collet Body SAS Series
74125	Collet Body SDG Series



SAFETY PRECAUTION: Read and follow all safety and operating instructions.
WARNING: Face & eye protection must be worn while operating power tools, per ANSI B186.1

Router Base Assembly



Part Number	Used On
1992	SRT10S25BB
1993	1971HP / SRT10S25BB
1994	1971HPC / SRT10S25BB

Laminate Base Trimmer

Part No. 1991

For use on SRT10S25LT series routers



Template Follower

Part No. 1990

For use on 1980 series routers
Accepts bits up to 7/16" (11 mm)



Reciprocating Saw Blades

Packaged in Cartons of 5



Part Number	Length		Teeth Per Inch
	in	mm	
For Use on Model 1300			
1815	6	150	10
1810	6	150	14
1813	4	100	14
1811	6	150	18
1812	4	100	18
1814	6	150	24
1816	6	150	6
1819	12	300	6

Template Guide Chart

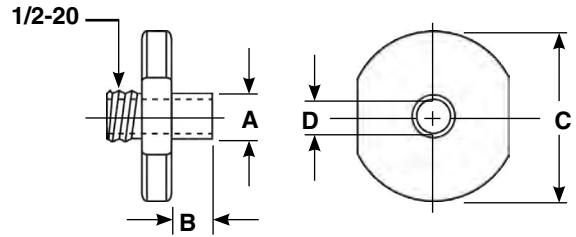

Part Number	Dimensions in Inches			
	A Pilot OD	B Pilot Length	C Flange OD	D Pilot ID
68613-12	3/8	1/4	3/4	9/32
68613-14	3/8	3/8	3/4	9/32
68613-16	3/8	1/2	3/4	9/32
68613-22	3/8	1/8	1-1/2	9/32
68613-24	3/8	1/4	1-1/2	9/32
68613-26	3/8	3/8	1-1/2	9/32
68613-40	7/16	1/4	3/4	21/64
68613-42	7/16	3/8	3/4	21/64
68613-44	7/16	1/2	1-1/2	21/64
68613-48	7/16	1/4	1-1/2	21/64
68613-50	7/16	3/8	1-1/2	21/64
68613-52	7/16	1/2	1-1/2	21/64
68613-62	1/2	1/4	1-1/2	11/32
68613-64	1/2	3/8	1-1/2	11/32
68613-66	1/2	1/2	1-1/2	11/32
68613-72	1/2	1/2	2-1/2	11/32



SAFETY PRECAUTION: Read and follow all safety and operating instructions.
WARNING: Face & eye protection must be worn while operating power tools, per ANSI B186.1

Filter, Regulator, Lubricator Assembly

Part No. 1660B

1/2" NPT fittings
Air Flow: 30 – 75 cfm



1660

Part Number	Description
1660B	Complete Air Control Unit, 1/2" PT
1661	Lubricator Only, 1/2" PT
1662A	Regulator with Gauge, 1/2" PT
1663	Manual Flex Drain Filter, 1/2" PT
1664	Manifold Block
1665	Connecting End Blocks
1666	Modular Sleeve ("O" Ring included)
1667	Automatic Drain – Optional
1668	Sleeve Wall Mounting Bracket

Filter, Regulator, Lubricator Assembly

Part No. 1651MA

3/4" NPT air fittings
Air Flow: Over 75 cfm



1651MA

Part Number	Description
1651MA	Complete Automatic Air Control Unit, 3/4" PT, larger capacity and float type filter for automatic drain
1652M	Lubricator only, 3/4" PT, 1 quart capacity
1654B	Regulator with Gauge, 3/4" PT
1653MA	Automatic Air Filter, 3/4" PT, automatic float drain empties when full

Air Regulator

Part No. 1335B

1/4" NPT Male/Female
 • Mounts inline with air inlet
 • Allows fine adjustment of air flow



Hi-Capacity Quick Change Couplers



1316



1391



1395

Part Number	Description	Thread
1316	Male Coupler Nipple	1/4" NPT
1317	Male Coupler Nipple	3/8" NPT
1318	Male Coupler Nipple	1/2" NPT
1391B	Quick Change Coupler	1/4" NPT
1392B	Quick Change Coupler	3/8" NPT
1393	Quick Change Coupler	1/2" NPT
1395	Female Coupler Nipple	1/4" NPT
1396	Female Coupler Nipple	3/8" NPT
1397	Female Coupler Nipple	1/2" NPT

Nylon Recoil Air Hose



1326

Part Number	ID		Length		Fittings
	in	mm	ft	m	
1326B	1/4	6	25	7.6	1/4" NPT
1327B	3/8	10	25	7.6	1/4" NPT

Sioux-Per Swivel

Allows the air hose to rotate 360° on 2 axes.



1338-25



1338FC-25

Part Number	Description
1338-25	1/4" non-regulated air swivel connector with safety pin
1338-38	3/8" non-regulated air swivel connector with safety pin
1338-50	1/2" non-regulated air swivel connector with safety pin
1338FC-25	1/4" regulated air swivel connector with safety pin

Balancers



2300-4B

Part Number	Capacity		Cable Length	
	lb	kg	ft	m
2300-4B	2 - 4	0.9 – 1.8	5.2	1.6
2300-6	4 - 6	1.8 – 2.7	6.7	2.0
2300-8B	6 - 8	2.7 – 3.6	6.7	2.0

Cutter Kit

Part No. 278



Sioux Part Number	Broach Cutter Size - Imperial
HB437	7/16"
HB500B	1/2"
HB562	9/16"
HB625	5/8"
HB750	3/4"
HB875	7/8"
HB100B	1"

Kit Includes:

HB01 – Arbor, HB02 – Pin, HB03 – Hex Key
 Case
 5 Cutters (1/2", 9/16", 5/8", 3/4", 7/8")



SAFETY PRECAUTION: Read and follow all safety and operating instructions.
WARNING: Face & eye protection must be worn while operating power tools, per ANSI B186.1

Grease Gun

Part No. 468A

Use with impact wrenches and multi-assembly angle tools.



Grease Gun

Part No. 439

Use with impact wrenches and multi-assembly angle tools.
For use with grease tube 1232A-04.



Grease Nozzle

Part No. 469A

Used with No. 468A grease gun.



Grease

Part Number	Description
289A	1 Quart
289A-1	2 Pounds
289A-2	6 Pounds
1198	6 Ounces
1198-1	2 Pounds
1198-2	6 Pounds
1232A	3 Ounces
1232A-02	1-1/2 Ounces
1232A-04	4 Ounces
1232A-1	1 Quart
1232A-2	1 Gallon

Air Motor Oil For Air Tools

Part No. 288

1/2 Pint

Part No. 288-1

1 Quart

Part No. 288-2

2 Liter



SAFETY PRECAUTION: Read and follow all safety and operating instructions.
WARNING: Face & eye protection must be worn while operating power tools, per ANSI B186.1

Service

Factory Authorized Service

Sioux Tools has Authorized Service Distributors conveniently located throughout the U.S., Canada and internationally to provide you with service virtually anywhere, anytime. Each is staffed with professional tool repair technicians who know Sioux tools, inside and out, and are able to provide complete and comprehensive repairs.

Each location features the newest in testing and inspection equipment to ensure your tool is repaired and serviced properly...the first time. Every tool that is serviced or repaired is calibrated and tested to the latest standards guaranteeing you the best performance possible.

See inside back cover for a complete listing of Authorized Service Distributors.

Training

Committed to your Success

To ensure your personnel are knowledgeable about not only Sioux products, but all air tools and products, Sioux Tools conducts training seminars that cover all aspects of the tools we sell. We offer introductory training seminars to help you understand our entire line of tools and their basic operation. Advanced training is tailored to individual needs to help build the skill of an experienced student. In addition, hands-on training is available with particular focus on troubleshooting and repairing.

For additional information on Sioux Tools training seminars, please contact your Sioux Tools Sales Representative.



U.S. Independent Service Centers

ALABAMA-Birmingham

Motion Industries
824 North 31st Street
35203
205-251-7522

Birmingham

Tool Smith Company, Inc
1300 Fourth Ave S
35233
205-323-2576
800-317-8665

Dothan

Brackin Wholesale Coatings
725 South Oates St
36301
334-793-4330

Montgomery

Fastening Solutions
3075 Selma Hwy
36108
334-284-8300

Winfield

McCaleb Tool Supply
710 Hwy 43 South
35594
205-487-2222

COLORADO-Denver

AIS Industrial & Construction Supply
3900 Ulster Street
80207
303-355-2391

FLORIDA-Daytona Beach

A A Casey Of Daytona Inc
1100 North Nova Rd
32117
386-253-6158

Doral

Air/Electric Tool & Equipment
7840 Nw 58th St
33166
305-593-5040

Largo

Nestor Sales/DBA Aim Supply
7337 Bryan Dairy Rd
33777
800-288-3091

Orlando

Air Products & Equipment Inc
165 Drennen Rd
32806
407-856-7603

Spring Hill

R & R Tool Repair, Inc
13591 Linden Dr
34609
352-263-3587

Tampa

Compressed Air Systems, Inc
9303 Stannum Street
33619
800-626-8177

GEORGIA-Marietta

Air Specialists Inc
598 Kirk Rd Nw
30060
770-426-1722

Snellville

Kentec Inc
3250 Centerville Hwy
30039
770-985-1907

IOWA-Bloomfield

Gingerich Logging & Supply
16700 Jade Ave
52537
515-830-4414

DesMoines

Peerless Supply Inc
1701 Guthrie Ave
50316
515-265-9905

Sioux City

The Sioux City Iron Co
310 South Floyd
51101
712-255-7696
800-831-2211

ILLINOIS-Chicago Heights

Chicago Air Power
22401 Joshua Dr
60411
708-758-8480
800-422-8202

Machesney Park

Engman-Taylor Co Inc
7980 Burden Rd
61115
800-236-7282

Mattoon

S & K Air Power
317 Dewitt Ave East
61938
217-258-8500

INDIANA-Elkhart

Alco Tool Supply Inc
54847 County Rd 17
46515
574-295-5535

Evansville

Lensing Tool & Supply
306 No 7th Ave
47730
812-425-9049

Fort Wayne

Mill Supplies Inc
5105 Industrial Road
46825
260-484-8566

Indianapolis

Alcorn Industrial Inc
5412 Rock Hampton Court
46268
317-872-6772

LOUISIANA-New Orleans

Beerman Precision Inc
4206 Howard Ave
70125
504-486-9391

MASSACHUSETTS-Everett

Panda Electrical Service
165 Main St
02149
617-389-1442

MAINE-Portland

M & W Tool Service
38 Portland St
04101
207-772-2057

MICHIGAN-Grand Rapids

Neumatic Specialty Inc
O-11319 First Ave Nw, Suite B
49534
616-791-9475

Walled Lake

Power Tools And Supply Service
8551 Boulder Ct
48390
800-829-7445

Warren

H & P Technologies Inc
21251 Ryan Rd
48091
586-758-0100

MINNESOTA-Minneapolis

Deko Factory Service
3048 Bloomington Ave So
55407
612-721-6651

Minneapolis

Tool Warehouse Inc
3410 East 42nd St
55406
612-722-4260

MISSOURI-Jefferson City

J C Industrial
706 Virginia St
65102
573-636-4171

Kansas City

Clark's Tool
74 Ne 69 Hwy
64119
816-452-7873

Saint Louis

Logan Gresham, Ltd
9 South Florissant Rd
63135
314-521-2400

MISSISSIPPI-Tupelo

Compressors & Tools Inc
105 Old Runway Rd
38801
662-844-7023

NORTH CAROLINA-Belmont

IDG
2100 The Oaks Parkway
28012
704-398-5600

Greensboro

Carolina Tool Sales And Repair, Inc
807 Huffman St
27405
336-275-6124

High Point

Air Power, Inc (NC)
1430 Trinity Avenue
27260
336-886-5081

High Point

High Point Pneumatics Inc
2430 English Rd
27262
336-889-8416

Kernersville

Airand LTD
218 Broken Saddle Lane
27284
336-993-6737

Oakboro

Tol-Co, Inc
159 Tol-Co Rd
28129
704-485-3301

NEBRASKA-Omaha

JDC Tool & Repair
6263 Abbott Dr
68110
402-455-6151

Omaha

Thacker Electric
8517 I Street
68127
402-592-9433

NEW YORK-Syracuse

Ace Hydraulic & Pneumatic
6720 Vip Parkway
13211
315-454-8989

OHIO-Apple Creek

Air Works
10680 Dover Rd
44606
330-698-0388

Columbus

Mitchell-Mckinney Supply Co
610 Greenlawn Ave
43223
614-444-6732

Richfield

Ohio Tool Systems
3863 Congress Parkway
44286
330-659-4181

Youngstown

Power Tool & Supply Co
3699 Leharps Rd
44515
330-792-1487

OKLAHOMA-Oklahoma City

Compressed Gas And Supply Inc
1301 West Reno
73106
405-235-9353

U.S. Independent Service Centers

Oklahoma City

Hydraulic Equipment Co LLC
2800 W. California Ave. Ste A
73107
405-235-3318

Tulsa

A O K Dist Corp
4717 So 83rd East Ave
74145
918-627-8116

Tulsa

Tool Center Inc
1447 North Yale
74115
918-838-7411

OREGON-Portland

Chas H Day Co, Inc
602 So East 11th
97214
503-232-1659

PENNSYLVANIA-Hanover

* C H Reed Co
301 Poplar St
17331
717-632-4261

Myerstown

Keystone Air Power
60 Elco Drive
17067
717-866-9224

TENNESSEE-Chattanooga

Production Tool Systems Inc
2100 S Holtzclaw Ave
37407
423-629-6822

Jackson

Compressors & Tools Inc
109 Anglin Lane
38301
731-421-8068

Johnson City

Summers Hardware & Supply Co
400 Buffalo Street
37604
423-461-4700

Memphis

Authorized Equipment Service
812 Polk Ave
38126
901-774-0850
800-238-2529

Memphis

Pro Power, Inc
7531 Bartlett Corp Cove E,
Suite 101
38133
901-383-7888

TEXAS-Fort Worth

Air & Electric Tool Co Inc
3440 So Grove St
76110
817-921-0231

Grand Prairie

Innovative Tooling Services
2506 West Marshall
75051
972-647-0800

Haltom City

Brad Kay Tools
2205 Moneda St
76117
817-834-6666

Houston

Houston Tool & Hoist Co
1401 Boyles St
77020
713-674-0912

Houston

Hydraulic Equipment Service
1021 N. San Jacinto St.
77002
713-228-9601

Houston

Innovative Tooling & Accessories
13203 Emmett Rd.
77041
713-996-9909
972-647-0800

Longview

Texas Air Hydraulic Service &
Sup
251 S Eastman Rd
75602
903-757-8211

UTAH-Salt Lake City

M & M Tool Supply
3362 So Main Street
84165
801-485-8200

VIRGINIA-Portsmouth

Capital Industrial Supply, LTD
800 Port Centre Parkway
23704
757-673-3900

Portsmouth

Hydraulic Service Co
3215 Victory Blvd
23702
757-487-2513

Roanoke

Stultz Mach Tools & Equip Inc
1546 Brownlee Ave SE
24014
540-981-9359
800-542-5747

WASHINGTON-Auburn

Mp Industrial
3902 West Valley Highway North,
Suite 306
98001
253-833-9119

Seattle

Diversified Facilities, Inc
9877 40th Ave South
98118
206-774-6873

Seattle

Universal Repair Shop Inc
1611 Boylston Ave
98122
206-322-2726

Spokane

Edge Construction Supply
1503 East Riverside Ave
99202
509-535-9841

WISCONSIN-Green Bay

Power Tool Service Co
300 North Webster Ave
54301
920-437-2594

Menomonee Falls

Engman-Taylor Co Inc
W142 N9351 Fountain Blvd
53051
800-236-1975

Racine

Machinery & Factory
1021 Sixth St
53403
262-634-3381

WEST VIRGINIA-Beckley

Hughes Supply Co
300 Rural Acres Dr
25801
304-252-1918

Canadian Independent Service Centers

ALBERTA-Calgary

Complete Power Tool Services
#9 7139 40th Street SE
T2C 2H7
403-720-0445

Edmonton

Quality Tool Repair
11420-156 Street
T5M 3N2
780-702-1686

BRITISH COLUMBIA-Burnaby

Westcoast Tool Sales & Service LTD
4008 Myrtle Street
V5C 4G2
604-873-5394

Kelowna

K Y Tools LTD
Unit 1-1115 Gordon Dr
V1Y 3E3
250-862-2575

MANITOBA-Winnipeg

Accutool Service Center
465 Lucas Ave
R3C 2E6
204-772-6523

Winnipeg

I Tech Tool Technology
171 Cole Ave
R2L 2C5
204-663-9266

Winnipeg

Tool World
171 Cole Ave
R2L 2C5
204-663-9266

NEWFOUNDLAND-St. John's

Rideout Tool & Machine Inc
222 Kenmount Road
A1B 3R2
709-754-2240

ONTARIO-Burlington

Air Tool Services LTD
920 Brant St Unit 14
L7R 4J1
905-639-5821

Toronto

Grip Clinch Canada
6-110 Claireport Cres
M9W 6P3
416-742-9161

QUEBEC-Anjou

Dorson LTEE
8551 Parkway Blvd
H1J 1N1
514-351-0160

Montreal

Instrument Sales & Service
6059 De Maisonneuve Blvd W
H4A 3R8
514-481-8111

SASKATCHEWAN-Regina

All Tool Repairs
3100 - 12th Ave
S4T 1J7
306-352-1756

Latin America Independent Service Centers

AGENTINA

Assembly S.R.L.
Brazin 1313 P.B. 4
Capital Federal 1154
Buenos Aires
Argentina
Phone: (54-1) 304-7390

BOLIVIA

Herracruz Importaciones
Av. Roca Y Coronado # 295
Santa Cruz de La Sierre
Bolivia
Sebra
Phone: (591) 335-41073

BRAZIL

Sebra
Snap-on-Latin
American/Caribbean Division
Rua Juscelino Kubitschek de
Oliveira 470
Distrito Industrial II
Santa Barbara D´ Oeste
CEP 13456-401 SP
Brazil
Phone: (55-19) 2108-1000

CHILE

Perfect Technology Chile S.A.
Av. Americo Vespucio
Norte 2880, Of 505
El Cortijo, Conchali
Santiago
Chile
Phone: (56-2) 362-1153

COLUMBIA

Dishegro
Diagonal 15 # 22- 18
Bogota
Colombia
Phone: (57- 1) 360-5967

Servitools LTDA

Carrera 58 Mp 14 - 14,
Zona Industrial Puente
Bogota
Colombia
Phone: (57-1) 420-3599

ECUADOR

Castillo Hermanos S.A.
Panamericana Norte KM 5.5
13135 Y Los
Quito
Ecuador
Phone: (593- 92) 247-7214
Najomez
Mosquera Narvaez 746 y
Carvajal
Quito
Ecuador
Phone: (593- 2) 2526-897

HONDURAS

Herramientas la Atlantica
2da. Calle, 17 Ave. N.E.
Col. Universal
Carretera Vieja a La Lima
San Pedro Sula
Honduras
Phone: (504) 557-6284

MEXICO

RC Maquinarias S.A. de CV
Calzada Ignacio Zaragoza
N° 377
Col. San Pedro
Puebla, Pue
Mexico
Phone: (52-222) 222-2587

RC Maquinarias S.A. de CV
Subsidiary
Calle Diego Rivera N° 39
Privada Diego Rivera
Col. Los Alcanfores C.P. 76150
Queretaro, Que
Mexico
Phone: (52-442) 217-7435

Snap-on Ssoun De Mexico,
S.A. de C.V.
Av Gustavo Baz, No. 166B
Colonia La Escuela
Tlanepantla, Edo de Mixico
Mexico 54090
Phone: (52-55) 5010-3000
www.snapon.com.mx

NICARAGUA

Sistemas de
Seguridad Buhler S.A.
Contiguo donde fue
Cine Dorado
Bolonía, Managua
Nicaragua
Phone: (505) 2222-6833

PARAGUAY

H Petersen
Av. Artigas 1552
Asuncion
Paraguay
Phone: (595-21) 202-615

PERU

Energotec S.A.
Calle Los Plasticos 204
Ate- Lima 3
Peru
Phone : (51-1) 348-7570
Igardí Herramientas S.A.
Av. Jaview Prado (FSTE) #1131
Lima
Peru
Phone : (30-5) 887-3533

VENEZUELA

Refiteca
Calle E. Boleita Norte
Edificio Alexandro
Local A. Semisotano
Caracas
Venezuela
Phone: (58-212) 235-8042
Hermaco
Av. Intercomunal N° 428
Ciudad Ojeda
Estado Zulia
Venezuela
Phone : (58-65) 260-994

United Kingdom Independent Service Centers

UK

Snap-on Tools LTD Repair Centre
Telford Way Industrial Estate
Kettering, Northants
NN168 PU, Great Britain
Phone: 011-44-1536-413903

SIOUX TOOLS INDUSTRIAL CATALOG | CONVERSION CHART

INCH			MILLIMETERS		INCHES		MILLIMETERS		INCHES		FOOT POUNDS		NEWTON METERS		FOOT POUNDS		NEWTON METERS	
1/64	.0156	0.397	26	1.0236	94	3.7008												
1/32	.0312	0.794	27	1.0630	95	3.7402					18	24.4	85	115.2				
	.0394	1.000	28	1.1024	96	3.7795					19	25.8	86	116.6				
3/64	.0469	1.191	29	1.1417	97	3.8189					20	27.1	87	117.9				
1/16	.0625	1.587	30	1.1811	98	3.8583					21	28.4	88	119.3				
5/64	.0781	1.984	31	1.2205	99	3.8976					22	29.8	89	120.7				
	.0787	2.000	32	1.2598	100	3.9370					23	31.2	90	122.0				
3/32	.0937	2.381	33	1.2992	110	4.3307					24	32.5	91	123.4				
7/64	.1094	2.778	34	1.3386	120	4.7244					25	33.9	92	124.7				
	.1181	3.000	35	1.3780	130	5.1181					26	35.3	93	126.0				
1/8	.1250	3.175	36	1.4173	140	5.5118					27	36.6	94	127.4				
9/64	.1406	3.572	37	1.4567	150	5.9055					28	38.0	95	128.8				
5/32	.1562	3.969	38	1.4961	160	6.2992					29	39.3	96	130.2				
	.1575	4.000	39	1.5354	200	7.8740					30	40.7	97	131.5				
11/64	.1719	4.366	40	1.5748	300	11.8110					31	42.0	98	132.9				
3/16	.1875	4.762	41	1.6142	400	15.7480					32	43.4	99	134.2				
	.1968	5.000	42	1.6535	500	19.6850					33	44.7	100	135.6				
13/64	.2031	5.159	43	1.6929	600	23.6220					34	46.1	110	149.0				
7/32	.2187	5.556	44	1.7323	700	27.5591					35	47.5	115	156.0				
15/64	.2344	5.953	45	1.7717	800	31.4961					36	48.8	120	163.0				
	.2362	6.000	46	1.8110	900	35.4331					37	50.2	125	170.0				
1/4	.2500	6.350	47	1.8504	1000	39.3701					38	51.5	130	176.0				
17/64	.2656	6.747	48	1.8898							39	52.9	135	183.0				
	.2756	7.000	49	1.9291							40	54.2	140	190.0				
9/32	.2812	7.144	50	1.9685							41	55.6	145	197.0				
19/64	.2969	7.541	51	2.0079							42	56.9	150	203.0				
5/16	.3125	7.937	52	2.0472							43	58.3	155	210.0				
	.3150	8.000	53	2.0866							44	59.7	160	217.0				
21/64	.3281	8.334	54	2.1260							45	61.0	165	224.0				
11/32	.3437	8.731	55	2.1654							46	62.4	170	231.0				
	.3543	9.000	56	2.2047							47	63.7	175	237.0				
23/64	.3594	9.128	57	2.2441							48	65.0	180	244.0				
3/8	.3750	9.525	58	2.2835							49	66.4	185	251.0				
25/64	.3906	9.922	59	2.3228							50	67.8	190	258.0				
	.3937	10.000	60	2.3622							51	69.1	195	264.0				
13/32	.4062	10.319	61	2.4016							52	70.5	200	271.0				
27/64	.4219	10.716	62	2.4409							53	71.9	225	305.0				
	.4331	11.000	63	2.4803							54	73.2	250	339.0				
7/16	.4375	11.112	64	2.5197							55	74.6	275	373.0				
29/64	.4531	11.509	65	2.5591							56	75.9	300	407.0				
15/32	.4687	11.906	66	2.5984							57	77.3	350	474.0				
	.4724	12.000	67	2.6378							58	78.6	400	542.0				
31/64	.4844	12.303	68	2.6772							59	80.0						
1/2	.5000	12.700	69	2.7165							60	81.3						
	.5118	13.000	70	2.7559							61	82.7						
33/64	.5156	13.097	71	2.7953							62	84.0						
17/32	.5312	13.494	72	2.8346							63	85.4						
35/64	.5469	13.891	73	2.8740							64	86.8						
	.5512	14.000	74	2.9134							65	88.1						
9/16	.5625	14.287	75	2.9528							66	89.5						
37/64	.5781	14.684	76	2.9921							67	90.8						
	.5906	15.000	77	3.0315							68	92.2						
19/32	.5937	15.081	78	3.0709							69	93.5						
39/64	.6094	15.478	79	3.1102							70	94.9						
5/8	.6250	15.875	80	3.1496							71	96.3						
	.6299	16.000	81	3.1890							72	97.6						
41/64	.6406	16.272	82	3.2283							73	99.0						
21/32	.6562	16.669	83	3.2677							74	100.3						
	.6693	17.000	84	3.3071							75	101.7						
43/64	.6719	17.066	85	3.3465							76	103.0						
11/16	.6875	17.462	86	3.3858							77	104.4						
45/64	.7031	17.859	87	3.4252							78	105.8						
	.7087	18.000	88	3.4646							79	107.1						
23/32	.7187	18.256	89	3.5039							80	108.5						
47/64	.7344	18.653	90	3.5433							81	109.8						
	.7480	19.000	91	3.5827							82	111.2						
3/4	.7500	19.050	92	3.6220							83	112.5						
49/64	.7656	19.447	93	3.6614							84	113.9						
25/32	.7812	19.844																
	.7874	20.000																
51/64	.7969	20.241																
13/16	.8125	20.637																
	.8268	21.000																
53/64	.8281	21.034																
27/32	.8437	21.431																
55/64	.8594	21.828																
	.8661	22.000																
7/8	.8750	22.225																
57/64	.8906	22.622																
	.9055	23.000																
29/32	.9062	23.019																
59/64	.9219	23.416																
15/16	.9375	23.812																
	.9449	24.000																
61/64	.9531	24.209																
31/32	.9687	24.606																
	.9843	25.000																
63/64	.9844	25.003																
	1.0000	25.400																

HEX SOCKET CONVERSIONS
 10mm=0.394"
 11mm=0.433"
 12mm=0.472"
 13mm=0.512"
 14mm=0.551"
 15mm=0.591"
 16mm=0.630"
 17mm=0.669"
 18mm=0.704"
 19mm=0.748"
 20mm=0.787"
 21mm=0.827"

Inch Lbs. x 0.113=Nm; Nm x 8.849=Inch Lbs.; Ft. Lbs x 1.356=Nm; Nm x 0.737=Ft. Lbs.



250 Snap-on Drive
 P.O. Box 1596
 Murphy, North Carolina USA 28906
 PH: 828.835.9765
 FAX: 828.835.9685
 TOLL FREE: 866.259.7291
 TOLL FREE FAX: 800.722.7236

Benelux
 Tel.: (N) 31 (0) 20 568 26 64
 (B) 32 (0) 14 23 19 67
 Fax: (N) 31 (0) 20 568 26 60
 (B) 31 (0) 14 23 26 27
 e-mail: snap@snap-on.nl

Latin America
 Tel.: 305-271-0944
 Fax: 305-271-7152
 e-mail: latinamerica.caribbean@snapon.com

Germany
 Tel.: 49 2104 9509-0
 Fax: 49 2104 9509-99
 e-mail: snapon.industrial@snapon.com

Italy
 Tel.: 00 39 02 66 04 53 70
 Fax: 00 39 02 61 29 78 15
 e-mail: indus.italia@snapon.com

United Kingdom
 Tel.: 44 (0) 1536-413904
 Fax: 44 (0) 1536-413874
 e-mail: industrialuk@snapon.com

Asia
 Tel.: 65-6451-5570
 Fax: 65-6451-5574
 email: esales.sg@snapon.com

Australia
 Tel.: 61 2 9837 9100
 Fax: 61 2 9624 2578
 e-mail: SOTA.customerservice@snapon.com



FORM# ZML0014
 PRINTED IN USA
 03/13 15M



www.siouxtools.com