

Desoutter



Industrial Tools



More Than Productivity

Table of Contents

DESOUTTER PRESENTATION

4-6

SELECTION GUIDE - ASSEMBLY TOOLS..... 7

BATTERY TOOLS

E-LIT series 8-13 B-FLEX 14-17

ELECTRIC NUTRUNNERS

Advanced tightening systems..... 18-21

ELECTRIC TRANSDUCERIZED EB TOOLS (Electric Brushless)

Tightening controllers - CVI3.....	22-25	Tightening controller - CVIR II	40-42
Torque range.....	26-27	Electric transducerized screwdrivers	43
Pistol grip electric nutrunners.....	28	Tightening controller - CVIL II.....	44
Angle head electric nutrunners.....	29	Handheld electric tools.....	45
In-line electric nutrunners.....	30	Tightening controllers - MultiCVIL II	46-48
Crowfoot & Tube nut tools.....	31	Fixtured electric spindles.....	49
Transducerized battery tool.....	32-33	Accessories - Software.....	50-51
Fixtured electric spindles	34-35		
Cables and Accessories	36-37		
PC and Networks / Software.....	38-39		

ELECTRIC CURRENT CONTROLLED EB TOOLS (Electric Brushless)

Tightening controllers - CVIC II.....	52-55	Angle head electric nutrunners	62
Torque range.....	56-57	In-line electric nutrunners	63
Electric screwdrivers	58	Fixtured electric spindles.....	64-65
Pistol grip electric nutrunners.....	59	Positioning system Posco 500 - Posco Vision	66-67
Pistol grip electric High torque	60-61	Cables and Accessories.....	68-69

ELECTRIC FASTENING TOOLS

Controllers - ESP1	70-71	Controllers - ESP C.....	76
Electric screwdrivers - SLB	72-73	Electric screwdrivers - SLC.....	77-78
Low voltage screwdrivers - SLK	74-75	Accessories	79

PNEUMATIC FASTENING TOOLS

Screwdrivers - Tool selection.....	80-87	Angle head - Non shut off	100
Screwdrivers - Shut off	88-90	Angle head - Direct drive.....	101
Screwdrivers - Shut off HLT	91	Crowfoot & Tube nut tools - Angle head	102
Fastening Assurance System - FAS3000	92-93	Torque controlled - Shut off.....	103
Screwdrivers - Non shut off.....	94-95	Accessories	104-107
Screwdrivers - Direct drive and Automatic reverse	96	Pulse tools - Shut off and non shut off	108-111
Screwdrivers high torque & Torque controlled - shut off.....	97	Ergonomic accessories - Stands.....	134-149
Angle head - Shut off.....	98-99		

TORQUE MEASUREMENT SYSTEMS

Torque and Angle Measuring units.....	112-113	Digital Static Transducers.....	120
Digital wrenches torque and angle.....	114-116	Measurement Accessories - Cables.....	121
Alpha Digital torque tester.....	117	Delta cart.....	122
Digital Rotary Transducers, torque and torque & angle.....	118-119	Software	123

CUSTOMIZED SOLUTIONS

Specific Nutrunners & Spindles / Multiplus / Arms / Screwfeeders..... 124-133

SELECTION GUIDE - RIVETING AND DRILLING 159

PNEUMATIC RIVETING / COMPRESSION TOOLS / PNEUMATIC DRILLS and TAPPERS

Riveting hammers.....	160-161	Multi drills	180-181
Compression tools - Riveting.....	162-168	Vacuum	182
Pistol grip drills.....	169-172	Tappers / Hole deburring and Rivet shaving.....	183
Straight grip drills.....	173	Rack feed drills.....	184-185
Angle drill selection.....	174	Accessories	186-189
Angle drills	175-179		

ADVANCED DRILLING UNIT..... 190-193

SELECTION GUIDE - REMOVAL TOOLS 195

PNEUMATIC GRINDERS / SANDERS

Grinders for carbide burrs, mounted points and sanding discs....	196-203	Sanders for abrasive discs, flap wheels	222-231
Routers	204	Dust extraction systems for grinders and sanders	232-239
Collet grinders accessories.....	205	Random orbital sanders, polishers and Orbital sanders	240-251
Grinders for type 1 wheels, cone wheels, depressed center wheels	206-221	Belt sanders.....	252-253

AUTO FEED DRILLS and TAPPERS..... 254-255

AIR MOTORS..... 256-257

MISCELLANEOUS TOOLS

Saws, Vacuum pen, Vacuum cleaner, Air scribe	258-259
--	---------

ACCESSORIES (most of the accessories are closed table products)

Ergonomic accessories - Stands	134-143	Tool holster - Automatic Screw Dispenser.....	148-149
Bench tidy kit	144-145	Fastening Accessories, Bits	150-157
Balancers.....	146-147	Air line Network.....	260-279

SAFETY INSTRUCTIONS..... 280-281

SOUND / VIBRATION LEVELS - INDEX (Search tool by model) - RIGHTWAY 282-291

Unless specified all inlet threads are BSP or NPT dependent on market

More Than Productivity

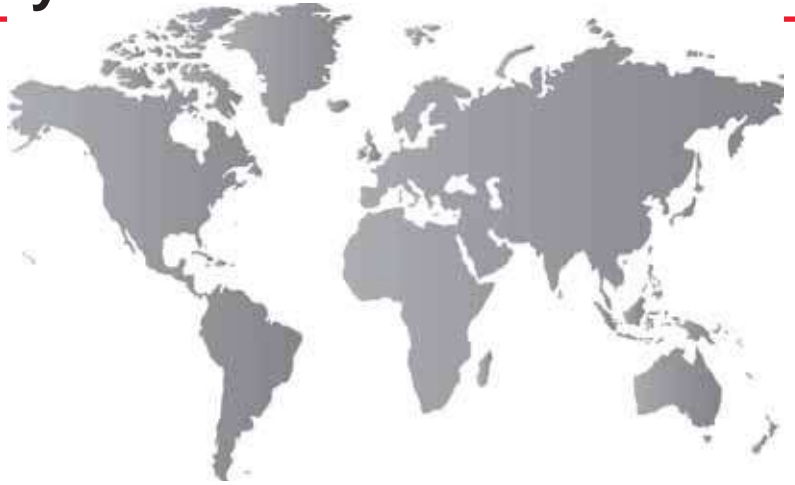

Desoutter is your single source of electric and pneumatic tool solutions, covering a wide range of assembly and manufacturing processes in the motor vehicle, aerospace, general industry and light assembly sectors

Desoutter has a long history of producing high-quality industrial tools. Today, the scope of the activity combines a global offering with a widespread local presence

The reason behind this approach is simple: our customers, who include many of the world's largest and most successful manufacturers, want worldwide access to a global portfolio of assembly and manufacturing solutions

With Desoutter, we provide you more than productivity

Focused on your objectives...

Industry hates risk. And so do we. So we work with you to eliminate cost, quality and performance risks from your production lines.

Optimize your investments

Your production lines are some of your company's most important investments. The quality and performance of **Desoutter** industrial tool solutions enable you to optimize your return on investments by producing more in the same cycle time. **Our airline systems, for instance, keep our pneumatic nutrunners spinning at exactly the right speed and power, saving you precious seconds for each operation.**

Increase revenues

Production line efficiency is worthless if the quality of your final goods generates costly recalls and after-sales support. With our industrial tool solutions, you produce consistently at high quality levels. **For example, our tightening control units enable you to error-proof complex assembly tasks and provide full traceability on the quality and sequence of operations.**

Raise productivity

Good ergonomics makes good economic sense. Not only are **Desoutter** tools designed to reduce operator stress factors, such as vibration and noise, they also take into account the relationship between the operator, the tool and the process. **Our experts work with you to obtain long-term gains in productivity and safety, while improving cost, quality and cycle times.**



Global solutions you can build on...

We know that finding the best solution is about much more than just picking a new tool. That is why we start every project by opening our ears, not our catalog.

Process optimization

Producing high-quality products requires high-quality processes. That is why many of the world's major motor vehicle, aerospace and appliance manufacturers rely on **Desoutter**. Each **Desoutter** solution is tailored to your exact needs. **Our experts propose solutions that deliver a quantifiable return on investment, whether in terms of productivity improvements, quality gains or safety improvements.**

Production transplantations

We believe firmly in the adage: "don't reinvent the wheel". Our customer service teams are experts at replicating best processes around the world. **When a major car maker wanted to duplicate a highly efficient wheel assembly solution in two new factories, it entrusted the project to Desoutter. Deployed in two**

factories to two very different markets, the replicated processes operate at the same speed and with the same quality as the original, despite sizeable differences in operator expertise.

Worldwide coverage

Desoutter combines global reach with local expertise. To ensure the smooth running of **Desoutter** solutions in your factories, all our local teams are trained to the same high level of expertise and service. Each team is in direct contact with the **Desoutter** area application and customer care center for your region. Together they ensure that **solutions are implemented to worldwide standards, but in compliance with local criteria.**





Expertise you can grow on...

From motors vehicles to appliances, planes to construction machines, electronics to energy – there is a Desoutter air powered and electric tool solution for you.

Covering all segments

Motor vehicle industry

Desoutter provides a wide range of tool solutions for vehicle makers, tier one suppliers and linebuilders. Solutions include fixed systems for engine and powertrain assembly, and handheld solutions for final assembly processes.

General industry

Desoutter solutions can be found in industrial fastening, assembly and material removal processes. Solutions include heavy-duty assembly systems, powerful material removal solutions and high torque off-road applications.

Aerospace

Desoutter has a long history of providing tools solutions to aerospace companies. We cover a wide range of their needs, from airframe and engine construction to system and furnishing assembly.

Light assembly

In their quest for ever higher quality levels, many major appliance and electronic manufacturers rely on Desoutter tools for error-proofed fastening and other business critical industrial processes.



Complete systems

Each Desoutter tool is designed as a full system, complete with its own accessories. **Taking a system-based approach has a dramatic effect on the productivity and longevity of your investment.** For example, our airline systems regulate and lubricate the air supply for pneumatic tools. Air quality is important, when you realize that a drop of just 8% in air pressure can slow drilling operations by nearly 40% (2 seconds per operation instead of 3.2 seconds).

Customized solutions

Our Applications Centers are the symbol of our renowned flexibility. As comprehensive as our catalog is, we know that sometimes you need a tailored solution. **Our Application Center engineers adapt existing solutions to your requirements and develop your own solutions.** They are experts at developing Six Sigma tools and error proofing.

Peace of mind you can count on...

Our support services keep your processes operating at maximum levels – and leave you to focus on your core business.

Maintenance contracts

Our maintenance contracts make **unexpected downtime a thing of the past.** They provide budget predictability and fixed price costs. Contracts are tailored to your needs and are available globally, regionally or for individual plants. By performing regular preventive maintenance you will experience less downtime and fewer emergency repairs. Maintenance contracts also lower your administrative and logistics costs.

Genuine Desoutter parts

Genuine Desoutter parts are the only parts designed and engineered specifically for Desoutter tools. They ensure that our tools always operate at their best. Moreover, for a lifetime of satisfaction, we always use genuine Desoutter spare parts when performing maintenance and repairs.

Accessories

In addition to providing you with the highest quality tools we also have an excellent range of

accessories including balancers, hoses, torque arms and consumables. Like all Desoutter tools these accessories are designed to offer the maximum productivity for all our customer applications.

Proactive logistics

When your operations are global, it is essential that your logistics are too. Our centralized inventory and warehousing system is highly responsive. We proactively manage our production to ensure a reliable supply of the products and parts you need. **The majority of the solutions in our catalog can be shipped to you in three days,** no matter where you are located. Next-day service is available in many markets.





Ensuring a lifetime of optimal tool performance:

Whether you are expanding your capacity or seeking to improve overall efficiency, Desoutter Services is the right place to start. With a global network that covers all the major markets of the world, and with over 100 years of experience, Desoutter Service is able to deliver a lifetime of "Peace of Mind™" and optimal operation.

Reduce downtime

The performance of your production lines depends largely on the uninterrupted operations of your tool systems. Emergency repairs and unplanned maintenance can generate costly downtime as well as lost production, and are more expensive than planned maintenance. By performing preventive maintenance and planning service intervention, we can optimize operational uptime.

Optimize productivity

Our training programs teach your operators how to get the most out of their tools while benefiting from optimal ergonomics. They also enable your line managers and process engineers to optimize applications, by providing reliable metrics.

Ensure quality

Too little maintenance can cause tool systems to under perform, increasing rejects, recalls and warranty claims. By servicing tools to operate at their best we can help you avoid defects caused by malfunctioning equipment. By identifying your precise calibration and maintenance needs, you avoid unnecessary reworking costs, not to mention costly tool repairs.

Control Costs

After performance, quality and productivity, the final hallmark of excellent tool maintenance is budget predictability. All our tool and account services are available with a fixed cost per tool, per system or per period. This gives you full control over your operating budget. In addition, our parts inventory management lowers administrative costs and capital expenditure.



Tool Services

Our experts can keep your tools running at their best, reducing downtime and helping in making costs more predictable. Thanks to our experience in power tools running in demanding applications all over the world, we can optimize the maintenance for each tool based on your application.

Installation & set-up

Get new tools up and running faster with our installation and set-up services. A qualified Desoutter service engineer commissions new tools to specification. To save time, tools are optimized through simulation before they are shipped out for installation. They are then tested and their performance verified online. Based on application and joint analysis, the engineer tunes each tool for maximum reliability. Depending on the customer's need, our engineers can then provide a follow up of the production during the ramp up and final line speed. This ensures that the highest tightening capability is achieved at mass production levels.

Repairs

We reduce the administrative hassle of managing repairs, thanks to fixed price repair service and rapid tool turnaround. We always take advantage of the repair time to perform a complete overhaul, which helps tools to last longer on the production line, ensuring high uptime. For even faster turnaround, we can keep exchange parts in stock as part of your service contract. We can track the repair history of all tools, and we can provide extensively analysis report of the services provided, throughout the life of the tools.

Preventive maintenance

We customize, through our dedicated software, our preventive maintenance plan to your application requirements, taking into account parameters such as annual cycles, cycle times, torque settings and joint quality. This reduces ownership costs and keeps tools working at their best. Preventive maintenance is available with fixed pricing to help you manage your budget better. In some cases, tools maintained by us are eligible for extended warranties. We offer Extended Warranty Programs that provide a comprehensive service/support program for new tool purchases. Please consult us on the Tool Care™ and extended warranty program.

Check-up & calibration

To enable you to meet quality system criteria and pass audits, we offer a complete calibration service. With it you get scheduling, full management and traceable documentation. Properly calibrated equipment provides confidence that your products meet their highest performance and specifications



Account Services

In addition to optimizing the individual tool performance, we also help you simplify tool management and ownership.

Full service plans

When managing a wide range of tool systems, it is important to keep costs under control. Our full service plans are tailored to your needs. They reduce spare part inventory, lower administration costs and provide budget predictability. Full service plans are available for single facilities or for multiple plants, whether in a single country, region or around the world. Desoutter will provide you with a full cost analysis and return of investment to ensure that you get the best optimization in caring for your equipment. Take the challenge and let us demonstrate it to you! Check out the new Peace of Mind™ service. With this offer the customer pays a fixed amount and gets three years of full repairs including spare parts, labor, preventive maintenance, calibration and management.

Extended Warranty Tool Care™

With this offer you need to follow all the recommended service intervals, and send the tools to our service center for the warranty extension preventive maintenance. We will then register and keep track of the tool, as well as inform you of the next due date, to keep the warranty period valid for the next extended period.

In-plant support

We provide dedicated customer service programs with in-plant technicians, which leaves you free to concentrate on your business. Our specialists handle the commissioning and calibration of equipment as well as process optimization, servicing and on-site joint analysis. We aim to keep all your tools running efficiently and smoothly, whether they are Desoutter tools or those of other manufacturers.

Training

To improve the performance of your operators and the expertise of your line managers, we provide comprehensive training and seminar programs. We offer hands-on training at your plant or at one of our training centres. Training covers tool function and handling and includes torque adjustment, case studies and the basics of threaded fastener assembly. By improving the knowledge and skills of your operators, you will increase operator job satisfaction and productivity.

Assembly Tools - Selection Guide

TOOL TYPE

PAGE

BATTERY TOOLS

8-17



ELECTRIC NUTRUNERS

18-21



ELECTRIC TRANSDUCERIZED EB TOOLS - PC & Networks/Software - CVI3

22-39



ELECTRIC TRANSDUCERIZED EB TOOLS - PC & Networks/Software - CVIR II / MULTICVIL II / CVIL II

40-51

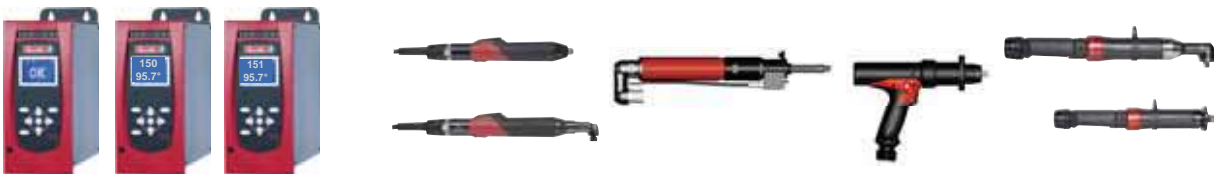

ELECTRIC CURRENT CONTROLLED EB TOOLS - CVIC / POSCO

52-69



ELECTRIC FASTENING TOOLS

70-79



PNEUMATIC FASTENING TOOLS

80-111



TORQUE MEASUREMENT SYSTEMS - Software

112-123



CUSTOMIZED SOLUTIONS: Screwfeeders - Multiplus - Arms

124-133









E-LIT Series - Optimize your performance

Clutch Battery Tool range



3 MODELS TO CHOOSE FROM	 BRUSHLESS MOTOR	 LI-ION BATTERY	 SPEED MODULE	 E-LIT BOX
E-LIT PLUS Electronic brushless (ELB) Pistol and Angle 	✓	✓		
E-LIT premium Electronic brushless speed control (ELS) Pistol and Angle 	✓	✓	✓	
E-LIT Wireless Communication with E-LIT Box (ELC) Pistol and Angle 	✓	✓	✓	✓



Speed setting

For ELS and ELC models

Two speed setting easily controlled by external module



Everything needed to optimize your assembly process

Guarantee quality and keep high productivity

- Decrease final speed to ensure tightening quality
- Avoid quality defects in your final product
- Decrease starting speed to facilitate bolt engagement

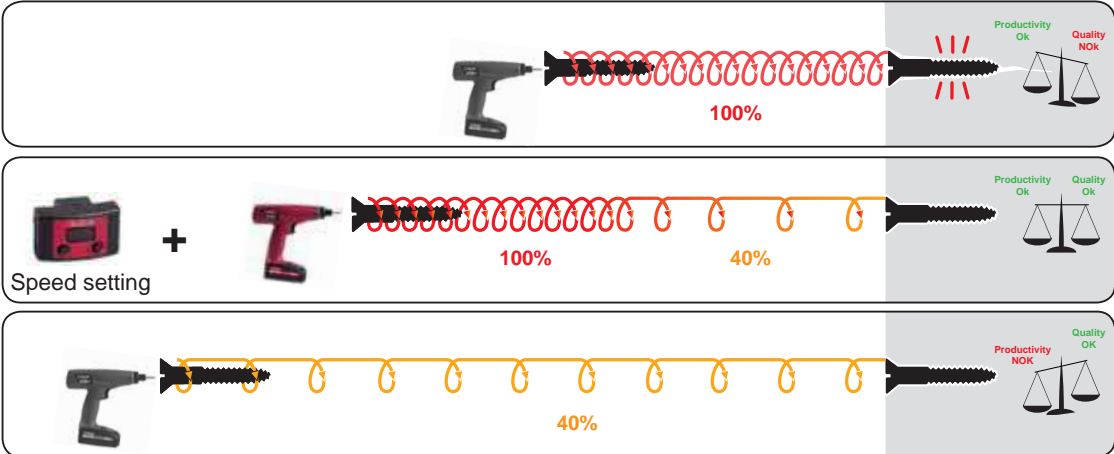

E-LIT BOX

For Poka-Yoke Application



E-LIT PC*

Tools and access point setup

- Restricted user access
- License evaluation: setup only
- License 1: results capture on 1 tool at a time
- License 2: unlimited access up to 16 tools at a time



* Check with your local Desoutter representative regarding availability on your market

E-LIT KEY*

For wireless communication

- Standalone unit for restricted area usage
- Up to 16 tools connected to one E-LITKEY
- Cycle results capture, storage and analysis
- Periodic reports creation



Accessories

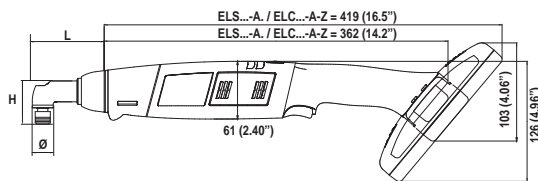
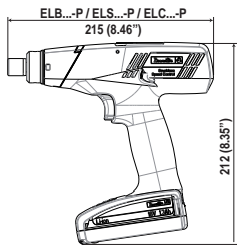

MODEL	H		L		Ø	
	mm	in.	mm	in.	mm	in.
ELS7 / ELC7	45.5	1.79	75.7	2.98	22	0.87
ELS15 / ELC15	41.5	1.63	75.7	2.98	22	0.87
ELS30 / ELC30	45.5	1.79	134.2	5.28	28	1.10
ELS45 / ELC45	51.1	2.01	144.6	5.69	35	1.38
ELS60 / ELC60	57.1	2.25	158.5	6.24	40	1.57



OPTIONAL ACCESSORIES					
ITEM	PISTOL	ANGLE HEAD 18V	ANGLE HEAD 36V	ELC tools	PART NO.
Battery type					
1 Li-ion Battery 18V 1.3 Ah - 0.35 kg (0.77lb)	✓	✓		✓	615 397 298 0
2 Li-ion Battery 18V 2.6 Ah - 0.60 kg (1.32lb)	✓	✓		✓	615 397 299 0
2 Li-ion Battery 36V 1.3 Ah - 0.60 kg (1.32lb)			✓	✓	615 396 750 0
Chargers					
3 Charger for Li-ion 230V - Europe - 18V	✓	✓		✓	615 397 300 0
3 Charger for Li-ion 120V - USA - 18V	✓	✓		✓	615 397 301 0
3 Charger for Li-ion 230V - UK - 18V	✓	✓		✓	615 397 302 0
4 Charger for Li-ion 230V - Europe - 36V			✓	✓	615 811 397 0
4 Charger for Li-ion 120V - USA - 36V			✓	✓	615 811 398 0
4 Charger for Li-ion 230V - UK - 36V			✓	✓	615 811 399 0
Cover protections					
5 Cover protection - Pistol	✓			✓	615 396 870 0
5 Cover protection - Angle <15Nm		✓		✓	615 397 672 0
5 Cover protection - Angle 30Nm			✓	✓	615 573 214 0
5 Cover protection - Angle 45Nm			✓	✓	615 573 215 0
5 Cover protection - Angle 60Nm			✓	✓	615 211 005 0
5 Cover protection - AH Housing		✓	✓	✓	615 211 004 0
6 Cover protection for battery 18V 1.3Ah					615 396 871 0
6 Cover protection for battery 18V 2.6Ah / 36V 1.3Ah					615 396 872 0
Miscellaneous					
7 Speed Setting Module (ELS/ELC version)	✓	✓	✓	✓	615 396 829 0
8 Pistol tool holster	✓			✓	615 804 914 0
9 Side handle - Pistol	✓			✓	615 396 757 0
10 Suspension bail - Pistol	✓			✓	443 703
11 Kit colour rings - Pistol (7 colors: white, yellow, orange, green, blue, purple, grey)	✓			✓	615 396 742 5
11 Kit colour rings - Angle tools (8 colors: white, yellow, orange, green, blue, purple, grey, black)		✓	✓	✓	615 970 114 5
12 Special heads adaptor - Pistol	✓			✓	615 810 695 0
13 E-LIT BOX-Z				✓	615 936 086 0
14 E-LIT BOX Starter kit				✓	615 929 048 0
15 Power supply E-LIT BOX				✓	615 927 053 0
16 E-LIT KEY				✓	615 929 047 0
17 Power supply E-LIT KEY				✓	615 927 054 0
• E-LIT PC evaluation				✓	615 927 684 0
• E-LIT PC level 1				✓	615 927 685 0
• E-LIT PC level 2				✓	615 927 686 0
Desolder Tool Holders					
18 DTH-42	✓			✓	107892
19 DTH TWIN (single) without rail		✓	✓	✓	615 811 411 0
20 DTH TWIN rail kit with 2 Twin holders	✓	✓	✓	✓	615 811 412 5
21 DTH TWIN stand kit with 2 Twin holders	✓	✓	✓	✓	615 811 413 5

E-LIT Series

0.4 to 60 Nm (3.5 to 531 in.lb) - 50 to 1550 rpm



A



B



C

PIC REF	MODEL	PART NUMBER	TORQUE RANGE		ROTATIONAL SPEED	OUTPUT DRIVE	WEIGHT WITHOUT BATTERY		VOLTAGE
			Nm	in.lb	rpm	in.	kg	lb	V
E-LIT PLUS - ELECTRONIC BRUSHLESS MOTOR									
A	ELB 2.5-1250-P	615 165 415 0	0.4-2.5	3.5-22	1250	Hex. 1/4 F	0.8	1.76	18
A	ELB 6-900-P	615 165 416 0	0.8-6	7.1-53	900	Hex. 1/4 F	0.8	1.76	18
A	ELB 6-670-P	615 165 440 0	0.8-6	7.1-53	670	Hex. 1/4 F	0.8	1.76	18
A	ELB 8-670-P	615 165 417 0	1.5-8	13.3-70	670	Hex. 1/4 F	0.8	1.76	18
A	ELB 12-600-P	615 165 418 0	3-12	26.5-106	570	Hex. 1/4 F	0.8	1.76	18
E-LIT PREMIUM - ELECTRONIC BRUSHLESS SPEED SETTING									
A	ELS 2.5-1550-P	615 165 419 0	0.4-2.5	3.5-22	500-1550	Hex. 1/4 F	0.8	1.76	18
A	ELS 6-1000-P	615 165 420 0	0.8-6	7.1-53	300-1000	Hex. 1/4 F	0.8	1.76	18
A	ELS 8-400-P	615 165 605 0	1.5-8	13.3-70	120-400	Hex. 1/4 F	0.8	1.76	18
A	ELS 8-800-P	615 165 421 0	1.5-8	13.3-70	300-765	Hex. 1/4 F	0.8	1.76	18
A	ELS 8-400-P4S	615 165 825 0	1.5-8	13.3-70	120-400	Sq. 1/4	0.8	1.76	18
A	ELS 12-600-P	615 165 422 0	3-12	26.5-106	250-570	Hex. 1/4 F	0.8	1.76	18
A	ELS 12-400-P4S	615 165 826 0	3-12	26.5-106	120-400	Sq. 1/4	0.8	1.76	18
B	ELS 7-360-A4S	615 165 725 0	1.5-7	13.3-62	120-360	Sq. 1/4	1.2	2.6	18
B	ELS 7-880-A	615 165 628 0	1.5-7	13.3-62	400-880	Hex. 1/4 F	1.2	2.6	18
B	ELS 15-480-A	615 165 629 0	5-15	44.2-133	200-480	Sq. 3/8	1.2	2.6	18
B	ELS 15-480-A4S	615 165 839 0	5-15	44.2-133	200-480	Sq. 1/4	1.2	2.6	18
C	ELS 30-300-A	615 165 630 0	10-30	88.5-265	100-300	Sq. 3/8	1.5	3.3	36
C	ELS 45-180-A	615 165 631 0	20-45	177-398	50-180	Sq. 3/8	1.5	3.3	36
C	ELS 60-145-A	615 165 632 0	25-60	221-531	50-145	Sq. 3/8	1.9	4.2	36
E-LIT WIRELESS - COMMUNICATION WITH E-LIT BOX									
A	ELC 6-1000-P-Z	615 165 701 0	0.8-6	7.1-53	300-1000	Hex. 1/4 F	0.8	0.8	18
A	ELC 8-400-P-Z	615 165 702 0	1.5-8	13.3-70	120-400	Hex. 1/4 F	0.8	0.8	18
A	ELC 8-800-P-Z	615 165 703 0	1.5-8	13.3-70	300-765	Hex. 1/4 F	0.8	0.8	18
A	ELC 12-600-P-Z	615 165 704 0	3-12	26.5-106	250-570	Hex. 1/4 F	0.8	0.8	18
B	ELC 7-360-A-Z	615 165 726 0	1.5-7	13.3-62	150-360	Sq. 1/4	1.2	2.6	18
B	ELC 7-880-A-Z	615 165 707 0	1.5-7	13.3-62	400-880	Hex. 1/4 F	1.2	2.6	18
B	ELC 15-480-A-Z	615 165 708 0	5-15	44.2-133	200-480	Sq. 3/8	1.2	2.6	18
C	ELC 30-300-A-Z	615 165 709 0	10-30	88.5-265	100-300	Sq. 3/8	1.5	3.3	36
C	ELC 45-180-A-Z	615 165 710 0	20-45	177-398	50-180	Sq. 3/8	1.5	3.3	36

Battery not included in standard offering

B-FLEX: performance and flexibility



Key points

BEST ERGONOMICS	HIGH TECHNOLOGY	QUALITY CONTROL
<ul style="list-style-type: none"> • Ergostop technology to avoid RSI (Repetitive Strain Injury) • Perfectly balanced grip design • Rebalancing with the two different battery positions • Operator comfort 	<ul style="list-style-type: none"> • Smart embedded HMI on tool • High resolution transducer • New motor dedicated to battery tools: high speed, high torque, low temperature 	<ul style="list-style-type: none"> • Direct feedback for the operator • Visible tightening results on tool HMI • Batch count • Torque strategy

B-FLEX: Ergonomy and Control

Torque transducer accuracy

Easy to set up

Visible torque & angle result

Batch count

ERROR PROOF QUALITY CONTROL

- Direct feedback for the operator
- Torque and Angle tightening result
- Torque control tightening strategy
- Batch count

NO PC NEEDED



Close / Open crowfoot

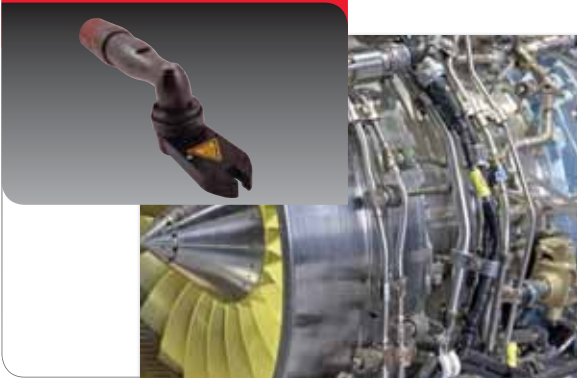

eDOCK for tool maintenance



Password protection

Battery level

Memory level

Easy setting

Results
10.03Nm
162.3DEG

Ergostop

Program setting

Ergo Stop Enable OK

Pset 1 Enable OK

Accessories

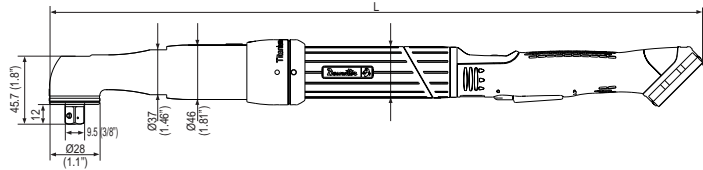

OPTIONAL ACCESSORIES

ITEM	PART NO.
Battery type	
1 Li-ion Battery 36V 1.3 Ah - 0.60 kg (1.32lb)	615 396 750 0
Charger	
2 Charger for Li-ion 230V - Europe - 36V	615 811 397 0
2 Charger for Li-ion 120V - USA - 36V	615 811 398 0
2 Charger for Li-ion 230V - UK - 36V	615 811 399 0
Miscellaneous	
3 Angle head protection EAB 15	615 211 003 0
3 Angle head protection EAB 26/32	615 573 207 0
3 Angle head protection EAB 45/50	615 573 208 0
3 Angle head protection EAB 60	615 573 209 0
3 Angle head protection EAB 75/95	615 573 210 0
4 Cover protection for battery 36V 1.3 Ah	615 396 872 0
5 eDOCK	615 811 976 0
Desoutter Tool holster	
6 DTH TWIN (single) without rail	615 811 411 0
7 DTH TWIN rail kit with 2 Twin holders	615 811 412 5
8 DTH TWIN stand kit with 2 Twin holders	615 811 413 5



B-FLEX Series

3 to 95 Nm (2.2 to 70 ft.lb) - 10 to 900 rpm



A



B



C

MODEL	L		h		H		øA		øB	
	mm	in.	mm	in.	mm	in.	mm	in.	mm	in.
EAB 15-900	470	18.5	17.0	0.67	45.7	1.80	28	1.10	37.0	1.46
EAB 26-560	496	19.5	17.0	0.67	45.7	1.80	28	1.10	37.0	1.46
EAB 32-410	496	19.5	17.0	0.67	45.7	1.80	28	1.10	37.0	1.46
EAB 45-330	506	19.9	17.0	0.67	35.0	1.38	35	1.38	37.0	1.46
EAB 50-450	546	21.5	17.0	0.67	35.0	1.38	35	1.38	37.0	1.46
EAB 60-370	559	22.0	17.0	0.67	35.0	1.38	35	1.38	37.0	1.46
EAB 75-300	582	22.9	17.5	0.69	60.4	2.38	45	1.77	48.9	1.92
EAB 95-240	582	22.9	17.5	0.69	60.4	2.38	45	1.77	48.9	1.92

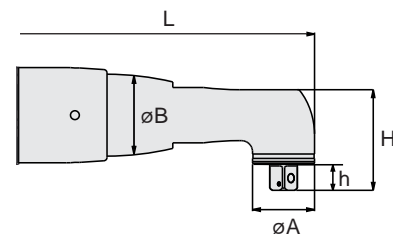

PIC REF	MODEL	PART NUMBER	SQUARE DRIVE	TORQUE RANGE						ROTATIONAL SPEED	WEIGHT WITHOUT BATTERY		VOLTAGE
				MIN.	RECOM-MENDED	MAX.	MIN.	RECOM-MENDED	MAX.		kg	lb	

B-FLEX - TRANSDUCERIZED BATTERY TOOL

			in.	Nm	Nm	Nm	ft.lb	ft.lb	ft.lb	rpm	kg	lb	V
A	EAB 15-900	615 165 731 0	1/4	3	13	15	2.2	9.6	11	900	1.55	3.42	36
B	EAB 26-560	615 165 732 0	3/8	5	24	26	3.7	18	19	560	1.65	3.64	36
B	EAB 32-410	615 165 733 0	3/8	7	30	32	5.2	22	24	410	1.65	3.64	36
B	EAB 45-330	615 165 734 0	3/8	9	40	45	6.6	30	33	330	1.76	3.88	36
B	EAB 50-450	615 165 735 0	3/8	9	45	50	6.6	33	37	450	2.04	4.50	36
B	EAB 60-370	615 165 736 0	3/8	10	55	60	7.4	41	44	370	2.35	5.18	36
C	EAB 75-300	615 165 737 0	1/2	12	70	75	8.8	52	55	300	2.94	6.48	36
C	EAB 95-240	615 165 738 0	1/2	19	90	95	14	66	70	240	2.98	6.57	36

Electric Nutrunners



CVI3 tools have been designed to deliver maximum comfort, high productivity and unmatched flexibility

- Monobloc, slim angle head for easy access to cramped areas
- Brushless, high duty-cycle motor for virtually no maintenance
- Internal tool bus (eLINK) for embedded error proofing accessories (i.e. barcode reader)
- 360° reporting with 4 separate colored LEDs (colorblind friendly)



CVI3 controllers provide both advanced process control & easy integration

- Exclusive TWINCVI3 solution for 2 spindle control in standard with synchro or asynchro modes
- Assembly process for advanced control of the complete operation (tightening & logic) without need for a dedicated PLC
- Embedded ethernet switch to simplify your Network installation by removing external switches
- Multiple battery tool management



CVI3 plug & play accessories bring maximum error proofing integration within each station

- Socket tray with exclusive tubes & inserts kit included for error proof process
- Stack light with 4 lamps, buzzer & key switch to detect & correct errors in the same workstation
- Operator panel with buttons, lamps & counters for intuitive interface & manual selection of setting



CVI3 cables take durability to a new level

- Cable auto-locking system on tool handle
- Simplified and guided 8-pin full digital connector for extended durability
- Embedded chipID with tightening counter for preventive cable maintenance



CVI3 battery tools give you more flexibility & operator feed back without compromising Error proofing

- Embedded OLED color display on tool
- Tailor-made operator comfort with two battery position possibilities
- Long life with a 36 volt Li-ion battery technology
- Oil and dust proof design with a patented "non-contact trigger"

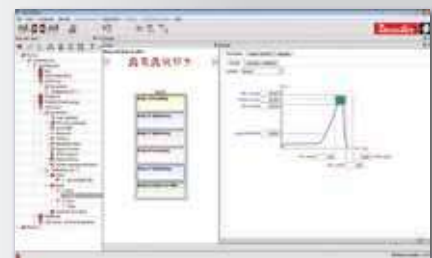

CVI3 Software suite provides user-friendly and visual interface to all plant users

- CVI CONFIG to set & monitor your systems point to point or via network with an intuitive and guided interface
- CVI ANALYZER to analyze & import/export tightening data with results, curves, filters, profiles
- CVINET WEB to collect & store 100% tightening data in a real-time database with advanced analytics via a web based software in service mode
- CVIKEY to create & manage tailor-made access rights per user profile
- CVI LOGIX (Soft PLC) to take the CVI3 process control to the next level

Advanced Tightening Systems

ELECTRIC TRANSDUCER CORDLESS

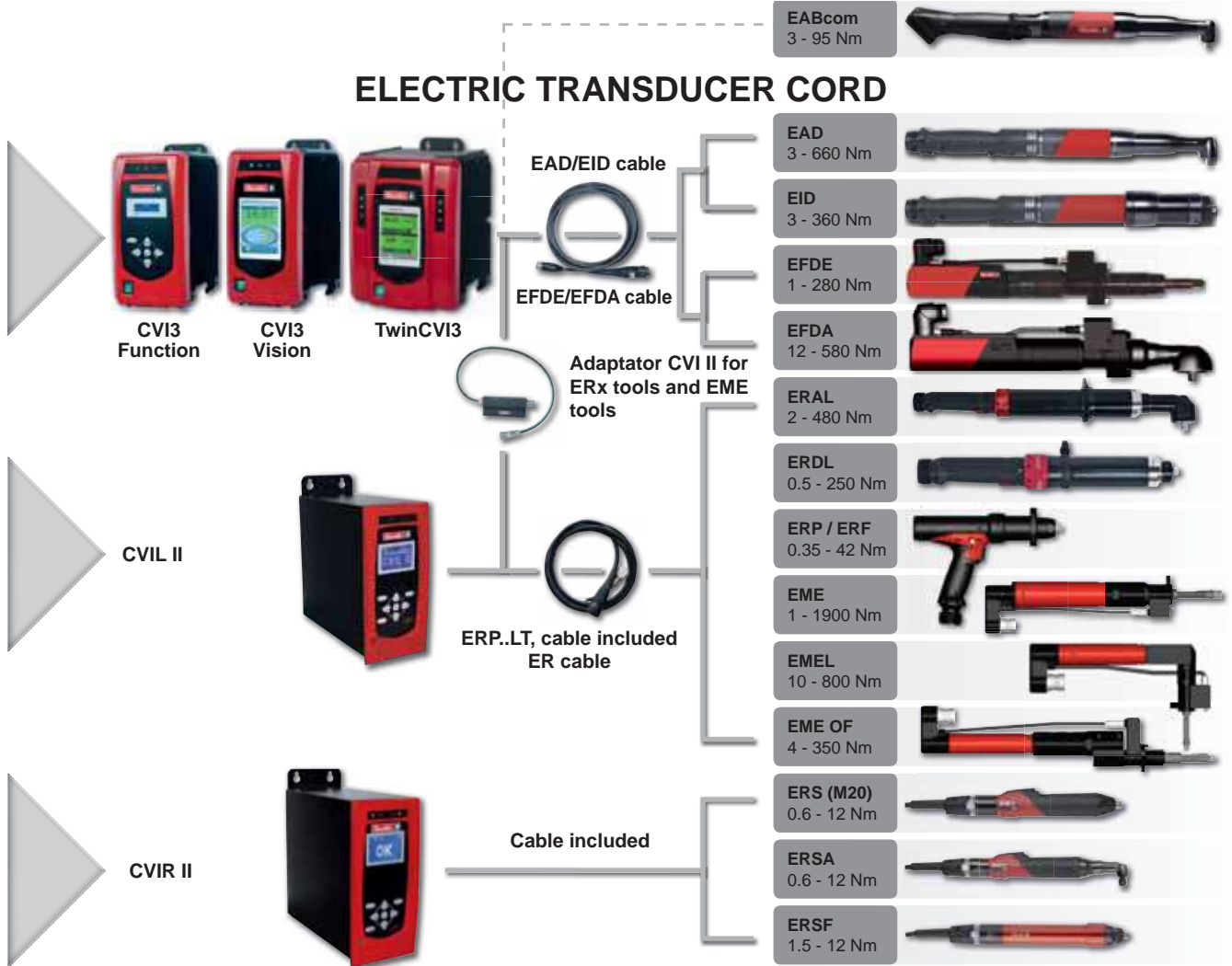

ELECTRIC CURRENT CONTROL

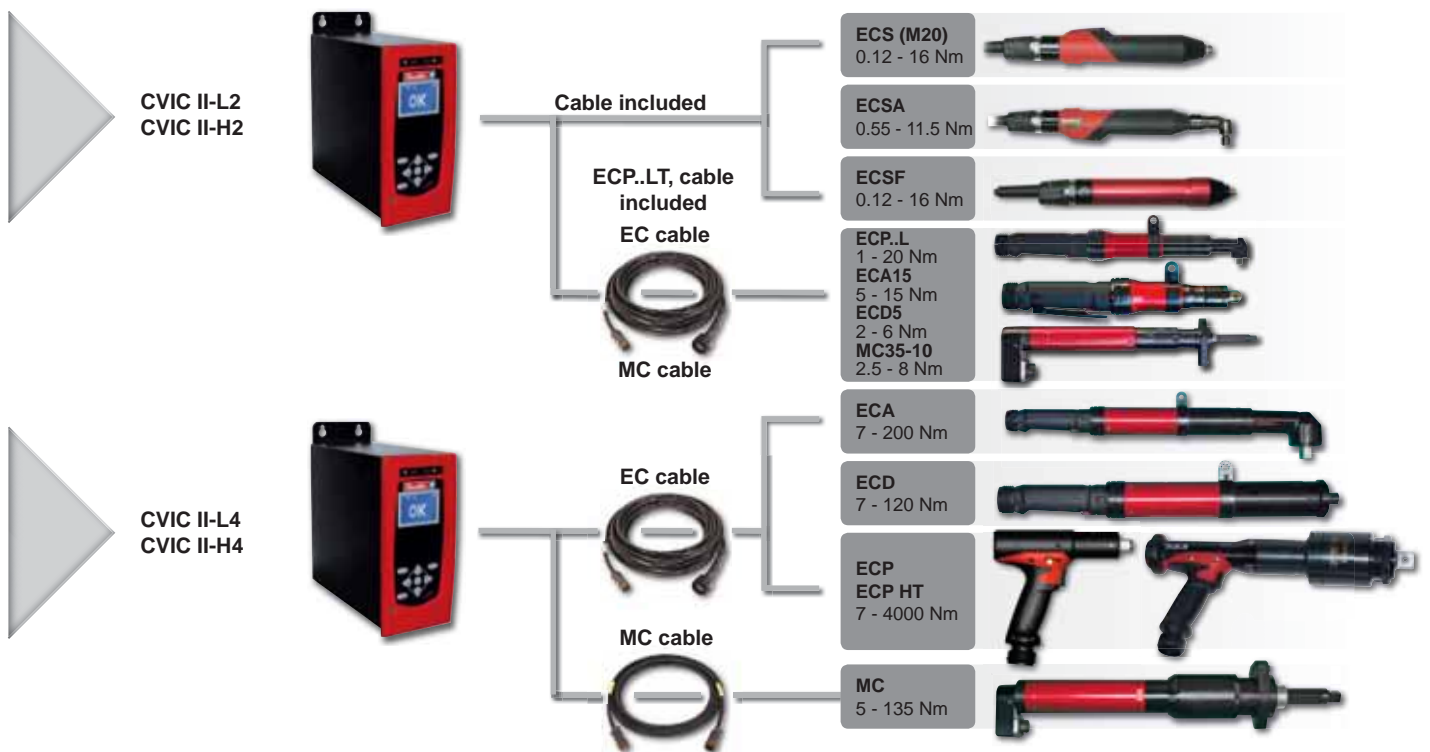

Advanced Tightening Systems

Desoutter CVI range - Features Matrix	CVIR II	CVIL II	MULTICVIL II	CVI3 Function	CVI3 Vision	TWIN CVI3	ePOD1	ePOD2	ePOD3	ePOD customer	Fieldbus modules	CVIKEY	Software License
Controllers & Options													
Reporting LED display 3 colors	x	x	x	x	x	x							
LCD screen	x	x	x	x									
6 buttons keyboard	x	x	x	x									
5,7" VGA Color touchscreen					x	x							
ePOD1: controller complete backup				ePOD	ePOD	ePOD	x	x	x	x			
ePOD2: ePOD1 + memory extension				ePOD	ePOD	ePOD		x	x	x			
ePOD3: ePOD2 + advanced functionalities				ePOD	ePOD	ePOD			x	x			
Fieldbus module: to activate Fieldbus communication	x	x	x	x	x	x					x		
CVIKEY: to create/manage access level USB keys				CVIKEY	CVIKEY	CVIKEY						x	
Storage													
Tightening results per controller (T, A, time, spindle, report...)	up to 20000	up to 10000	up to 32000	10000	10000	10000		20000	20000	20000			
Assembly process results per controller (report)				1000	1000	1000		2000	2000	2000			
Curves per spindle (OK/NOK)	10	10	10	20	20	20		50	50	50			
Pset history per Pset (previous Pset versions stored)				10	10	10		20	20	20			
Event log storage (number of events)				500	500	500		1000	1000	1000			
Basic Functions													
Nbr of cord tools	1	1	2 to 32	1	1	2							
Nbr of Psets	50	50	31	250	250	250							
Nbr of steps per Pset	15	15	20	15	15	15			40				
Batch count in Pset/Cycle	999	999	999										
Batch count in Assembly Process				999	999	999							
Run ERAL/ERDL/ERP/EME tools	ERS only	x	x										
Run ERAL/ERDL/ERP/EME tools with CVI II adapter				x	x	x							
Run EAD/EID/EFD tools				x	x	x							
Run EAB/EPB tools					x	x							
Pset Learning mode	x	x	x	x	x	x							
Simple Pset				x	x	x							
Tube nut reindexing		x	x	x	x	x							
Jog	x	x	x	x	x	x							
Rehit / Cross threads detection				x	x	x							
Socket release				x	x	x							
Ergostop	x	x		x	x	x							
Reject management	x	x	x	x	x	x							
Identifier(s) traceability (VIN, S/N)	1	1	1	10	10	10							
Identifier to select Pset	x	x	x	x	x	x							
Statistics: CPK, ISO, CNOMO, NF	x	x	x	x	x	x							
Realtime Statistical Process Control: SPC & alarm				x	x	x							
Advanced Functions													
Nbr of Assembly Processes (START/PROCESS/POST)				250	250	250							
Nbr of START conditions per Assembly Process				50	50	50							
Nbr of PROCESS Actions per Assembly Process				32	32	32							
Nbr of POST Actions per Assembly Process				8	8	8							
Assembly process: Sequence selection with start-, process- & post-conditions in static/dynamic mode for 1 controller				x	x	x							
Identifier to select Assembly Process				50	50	50							
Remote Programming: Visualization + Programming of several controllers from 1 controller (up to 20)					x	x				x	x		
Controller complete backup				ePOD	ePOD	ePOD	x	x	x	x			
Controller memory extension				ePOD	ePOD	ePOD		x	x	x			
Workgroup - MASTER Access point: 1 Network/Fieldbus connection per group of up to 12 controllers					ePOD	ePOD				x	x		
Workgroup - MASTER Assembly Process: Assembly process - Advanced management for a group up to 12 tools					ePOD	ePOD				x	x		
Workgroup - MASTER Synchro: Pseudo multi-controller synchronisation up to 12 tools			x (up to 32 channels)		ePOD	ePOD				x	x		
Access Level Management with USB keys				CVIKEY	CVIKEY	CVIKEY						x	
Strategies & options													
CW / CCW operation	x	x	x	x	x	x							
Tightening steps: Tightening	x	x	x	x	x	x							
Tightening steps: Loosening	x	x	x	x	x	x							
Tightening steps: Prevailing	x	x	x	x	x	x							
Tightening steps: Selftap				x	x	x							
Reject management steps: jump, action on NOK, stop	x	x	x	x	x	x							
Measurement controls : overall angle, overall time				x	x	x							
Tightening modes - BASIC (working CW / CCW): *Control: torque, angle *Monitoring: torque, angle, current, time *Monitoring	x	x	x	x	x	x							
Tightening modes - STANDARD (working CW / CCW): *Control: torque OR angle, torque & angle				x	x	x							

Advanced Tightening Systems

Desoutter CVI range - Features Matrix	CVIR II	CVIL II	MULTICVIL II	CVI3 Function	CVI3 Vision	TWIN CVI3	ePOD1	ePOD2	ePOD3	ePOD customer	Fieldbus modules	CVIKEY	Software License
Tightening modes - ADVANCED (working CW / CCW): *Control: yield, torque rate *Monitoring: yield, torque rate, 2nd torque, 2nd angle, 2nd part angle			x	ePOD	ePOD	ePOD			x	x			
Monitoring: Torque rate only	x	x	x	x	x	x							
Speed management per step - BASIC: 1 speed	x	x	x	x	x	x							
Speed management per step - ADVANCED: 2 speeds, 3 speeds - Ergospeed, Autospeed, Auto Set up				x	x	x							
Synchro BASIC: Step synchro by I/O between controllers	x	x	x	x	x	x							
Synchro ADVANCED: Torque synchro				ePOD	ePOD	ePOD			x	x			
Hold torque		x	x	ePOD	ePOD	ePOD			x	x			
Seating detection	Soft. License			ePOD	ePOD	ePOD			x	x			
Home position				ePOD	ePOD	ePOD			x	x			
Connectivity													
USB port (Download results/curves/config/logs, upload firmware, CVIKEY profile key)				1	1	1							
RS232 port (PC programming point to point)	1	1	1										
Ethernet port (PC programming point to point)	1	1	1	1	1	1							
ePOD port				1	1	1							
USB ports (Barcode reader)				2	2	2							
I/O (24V) - Internal to controller	8/8	7/8	8/8	8/8	8/8	8/8							
I/O (24V) - External expandable (option)			32/32	120/120	120/120	120/120							
Configurable I/O mapping	x	x		x	x	x							
Remote tool start	x	x	x	x	x	x							
Fieldbus module port	1	1	1	1	1	1							
Configurable Fieldbus memory mapping (drag & drop interface)	x	x	x	x	x	x							
eBUS port (optional accessories port - daisy chain up to 15 devices)				1	1	1							
Socket tray - 4 positions (optional accessory)	x	x	x	x	x	x							
Stack light (optional accessory)				x	x	x							
I/O expander 8 In / 8 out (optional accessory)				x	x	x							
Operator panel (optional accessory)				x	x	x							
RS232 port (Barcode reader, Delta, report output, Open protocol)	1	1	1	2	2	2							
Ethernet ports (Remote Network programming, Data collection, process control)	1	1	1	4	4	4							
Embedded Ethernet switch (1 or 2 networks)				x	x	x							
Modbus TCP	x	x	x	x	x	x					x		
Profibus DP	x	x	x	x	x	x					x		
ProfiNet IO - Class A (1 port)	x	x	x	x	x	x					x		
ProfiNet IO - Class B (2 ports)	x	x	x	x	x	x					x		
Ethernet-IP	x	x	x	x	x	x					x		
DeviceNet	x	x	x	x	x	x					x		
Standard Protocols													
TOOLSNET 3000 reporting (results only)	Firm. License			x	x	x							x
TOOLSNET 4000 reporting (results/curves)	Firm. License (results only)			x	x	x							x
Open protocol - Ethernet	Firmware license			x	x	x							
Open protocol - Serial				x	x	x							
Customer Protocols													
VW/AUDI Master PC (XML only)				ePOD	ePOD	ePOD				x			
VW/AUDI Master PLC (XML + Fieldbus)				ePOD	ePOD	ePOD				x			
VW/AUDI OPEN PROTOCOL				ePOD	ePOD	ePOD				x			
CHRYSLER PFCS				ePOD	ePOD	ePOD				x			
VOLVO SJC				ePOD	ePOD	ePOD				x			
Softwares													
CVIPC2000 for CVIx2 - Programming software	Soft. License												x
CVI CONFIG- Programming software				Soft. License									x
CVIMONITOR - Remote monitoring software (results, curves, I/Os, maintenance diagnostic, Logs)				x	x	x							
CVI ANALYZER - Data analyzing software				Soft. License									
CVINET WEB - Data collection software	Soft. License			Soft. License									x
CVIKEY - Access level management software				CVIKEY	CVIKEY	CVIKEY						x	
SoftPLC - ISaGRAF			x										
SoftPLC - CVILOGIX				ePOD	ePOD	ePOD		x	x	x			
Maintenance													
Remote diagnostic software - CVIMONITOR				x	x	x							
Problem solving webserver with QR codes				x	x	x							
Access to all tools parameters	x	x	x	x	x	x							
Cycles counters for tool with service indicator	x	x	x	x	x	x							
Cycles counters for controller with service indicator	x	x	x	x	x	x							
Cycles counters for cable with service indicator				x	x	x							
Autotest of the complete system	x	x	x	x	x	x							
Manual calibration	x	x	x	x	x	x							
Automatic calibration (Delta)	x	x	x	x	x	x							

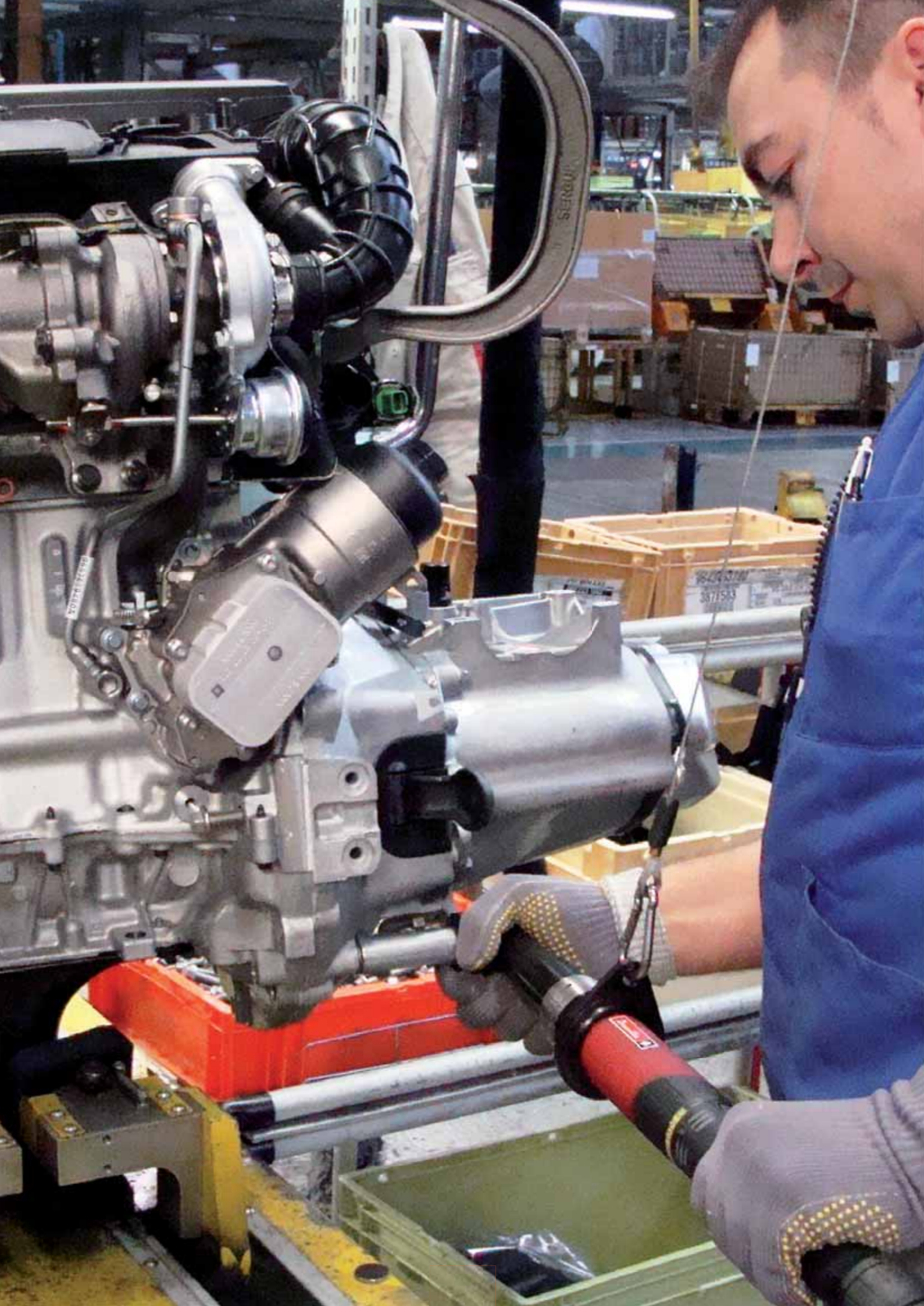

The new standard of Value in Efficient Tightening...

In an era of FLEXIBLE manufacturing and the race to ZERO-fault assembly, Desoutter is proud to introduce the new standard of Value in Efficient Tightening for safety-critical applications: CVI3 assembly system

This new system offers unequalled EFFICIENCY for all plants thanks to the best combination of advanced process control, easy integration, user-friendly interface & unmatched flexibility

The CVI3 system integrates UNIQUE added value INNOVATIONS:

Reduce rework cost: complete station process control including tightening & logical operations without need for a dedicated PLC > **Assembly Process**

Decrease installation/re-balance cost: Fast & easy line re-balancing with multiple Battery transducerized tools connected to 1 CVI3 controller > **EAB cordless tools**

Improve quality with intuitive software: User-friendly & visual interface to view tightening data & detect quality issues > **CVI ANALYZER**

Optimize flexibility: 2 fixtured spindles synchronized or asynchronous in standard > **TWINCVI3**

**ADVANCED
PROCESS
CONTROL**

**EASY
INTEGRATION**



**UNMATCHED
FLEXIBILITY**

**USER-FRIENDLY
INTERFACE**



Technical features

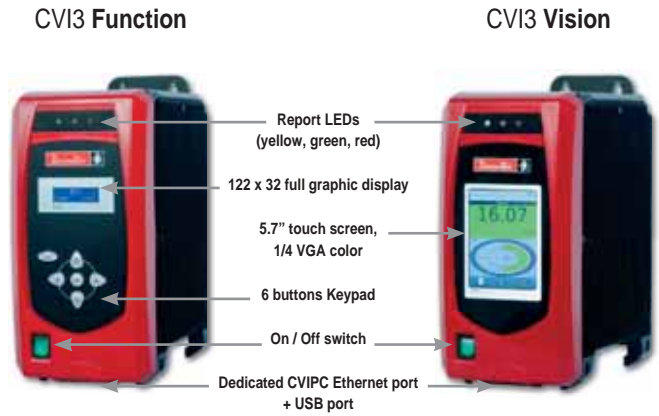
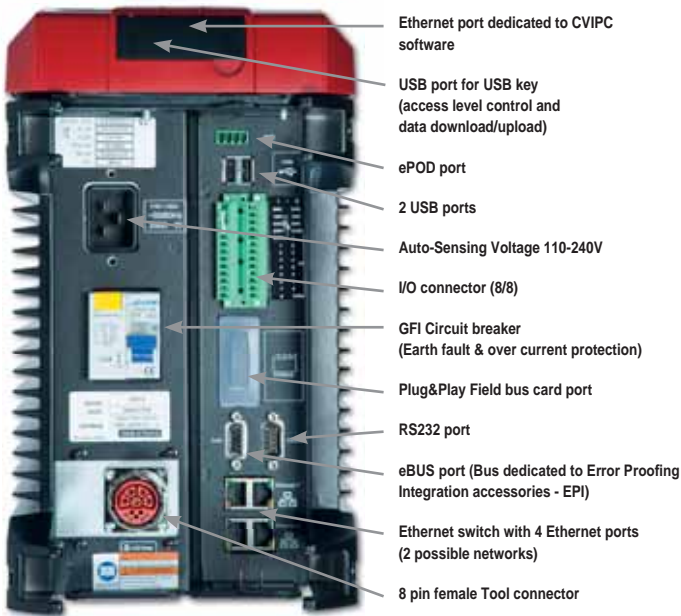

FEATURES	CVI3 FUNCTION	CVI3 VISION	TWINCVI3 Synchro/Asynchro
Controllers			
Weight - kg (lbs)	9.3 (20.5)	9.3 (20.5)	15 (33.1)
Volume (dm ³)	19.5	19.5	29.6
Color touchscreen		✓ (5.7")	✓ (5.7")
Storage			
Pset results (torque, angle, date, time, report)	10000	10000	10000/20000
Pset curves (OK/NOK)	20	20	20/40
Sequence results	1000	1000	1000/2000
Event log storage (number of events)	500	500	500
Basic Functions			
Nbr of Psets	250	250	250
Nbr of steps per Pset	15	15	15
Barcode reading (standard and 2D)	✓	✓	✓
Learning mode	✓	✓	✓
Quick Pset	✓	✓	✓
Tubnut release	✓	✓	✓
Advanced Functions			
Access Level Control/Management with unlimited profiles	✓	✓	✓
ID input to select Sequence (up to 4 different identifiers)	✓	✓	✓
Number of Sequences	250	250	250
Advanced Soft PLC (in option with CVILOGIX)	✓	✓	✓
1 Network/Fieldbus Access point per group of up to 12 controllers		✓	✓
Remote Programming for a group of up to 20 controllers from 1 controller		✓	✓
Full synchronized control for a group of up to 12 controllers (static/dynamic)		✓	✓
Tightening strategies			
*Control: torque, angle, torque OR angle, torque AND angle, yield point, torque rate	✓	✓	✓
*Monitoring: yield point, torque rate, 2nd torque, 2nd angle, 2nd part angle, current, slip off, stick slip	✓	✓	✓
Connectivity			
Configurable I/O	8/8	8/8	8/8
USB ports (2 + 1 front)	✓	✓	✓
Embedded Ethernet switch (4 ports + 1 front – 2 networks)	✓	✓	✓
Dedicated Bus for up to 15 accessories in daisy chain	✓	✓	✓
Optional Fieldbus			
Plug&Play Fieldbus card port (EthernetIP, ProfiNet A/B, Modbus TCP, Device-Net, Profibus, CC-Link)	✓	✓	✓
Fieldbus dynamic memory mapping	✓	✓	✓

Controllers



A



B



C

PIC REF	MODEL	PART NUMBER	CONSUMPTION (CURRENT)		MAIN SUPPLY	WIDTH		DIMENSIONS HEIGHT		DEPTH		WEIGHT	
			115V	220V		50/60 Hz	mm	in.	mm	in.	mm	in.	kg
A	CVI3 Function	615 932 690 0	4A	2A	Single-phase	175	6.9	361	14.2	310	12.2	9.3	20.5
B	CVI3 Vision	615 932 691 0	4A	2A	Single-phase	175	6.9	361	14.2	310	12.2	9.3	20.5
C	TWINCVI3	615 932 697 0	8A	4A	Single-phase	265	10.4	361	14.2	310	12.2	15.0	33.1

CVIMONITOR included with controller: License free remote software for realtime monitoring of results, curves, I/O status, Fieldbus diagnostic, calibration & maintenance indicators

POWER CORD

to be ordered with the controller

PLUG	DESCRIPTION	PART NO.
A	European	615 917 069 0
B	US	615 917 063 0
C	UK	615 917 070 0
D	Chinese	615 917 061 0

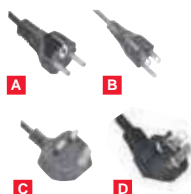

OPTIONAL ACCESSORIES

ITEM	PART NO.
Software	
• CVI CONFIG - 1 user	615 927 699 0
• CVI CONFIG - 5 users	615 927 700 0
• CVI CONFIG - 25 users	615 927 701 0
• CVI ANALYZER - 1 user	615 927 696 0
• CVI ANALYZER - 5 users	615 927 697 0
• CVI ANALYZER - 25 users	615 927 698 0
• Upgrade from CVI NET to CVINET WEB 1 cont.	615 927 740 0
• Upgrade from CVI NET to CVINET WEB 10 cont.	615 927 741 0
• Upgrade from CVI NET to CVINET WEB 25 cont.	615 927 742 0
• Upgrade from CVI NET to CVINET WEB 50 cont.	615 927 743 0
• Upgrade from CVI NET to CVINET WEB 200 cont.	615 927 744 0
• CVINET WEB - 1 cont.	615 927 555 0
• CVINET WEB - 10 cont.	615 927 549 0
• CVINET WEB - 25 cont.	615 927 550 0
• CVINET WEB - 50 cont.	615 927 551 0
• CVINET WEB - 200 cont.	615 927 560 0
• CVIKEY (access level management on USB key)	615 927 676 0
• CVILOGIX - Basic (Basic Ladder with Function Bloc Diagrams)	615 927 606 0
• CVILOGIX - Advanced (Advanced workbench for Automation)	615 927 607 0

OPTIONAL ACCESSORIES

ITEM	PART NO.
Fieldbus modules	
1 Profibus module	615 927 595 0
2 ProfiNet module (1 port)	615 927 596 0
3 ProfiNet module (2 ports)	615 927 597 0
4 DeviceNet module	615 927 599 0
5 EtherNet IP module	615 927 594 0
6 Modbus TCP module	615 927 615 0
ePOD	
7 ePOD1	615 936 075 0
7 ePOD2	615 936 076 0
7 ePOD3	615 936 077 0
7 ePOD customer	615 936 078 0
Others Accessories	
8 Table mounting	615 397 399 5
9 Wall mounting CVI3 Function/Vision	615 397 631 5
10 Wall mounting TWINCVI3	615 811 897 0

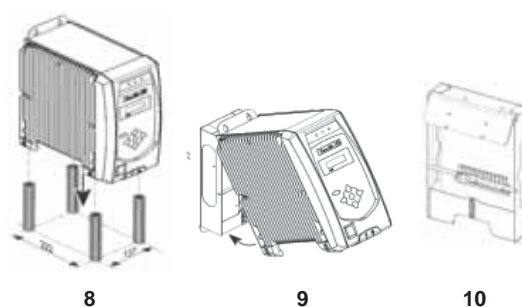

Torque Range - Portable electric nutrunners

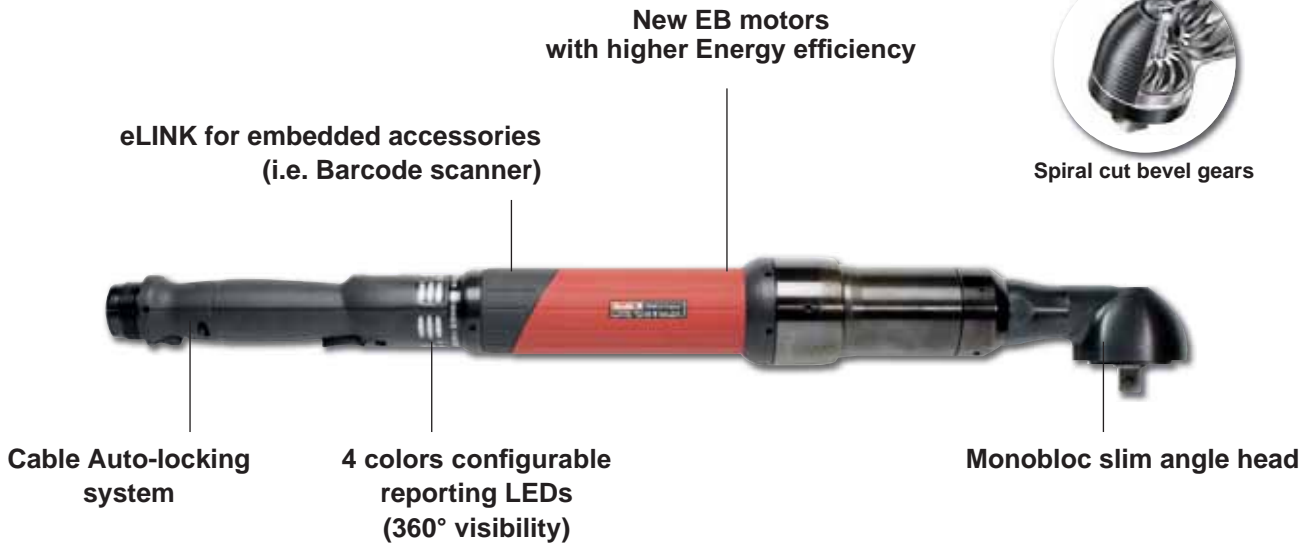

Performance of Portable electric nutrunners - EAD, EID, EABC and ERP

Angle head tools (EAD) - Widest Torque Ratio (T_{max}/T_{rpm}) 5.2 ROTATIONAL SPEED rpm

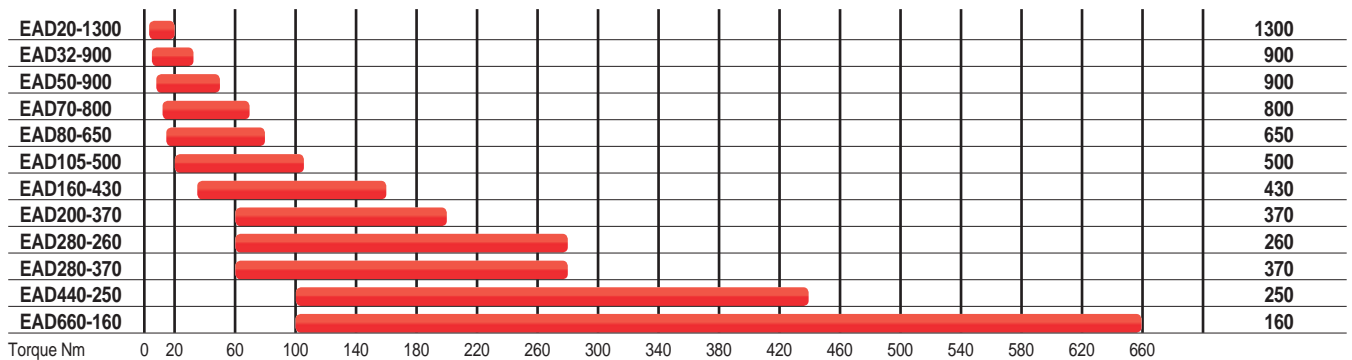

In-line tools (EID) - Widest Torque Ratio (T_{max}/T_{rpm}) 5.9 ROTATIONAL SPEED rpm

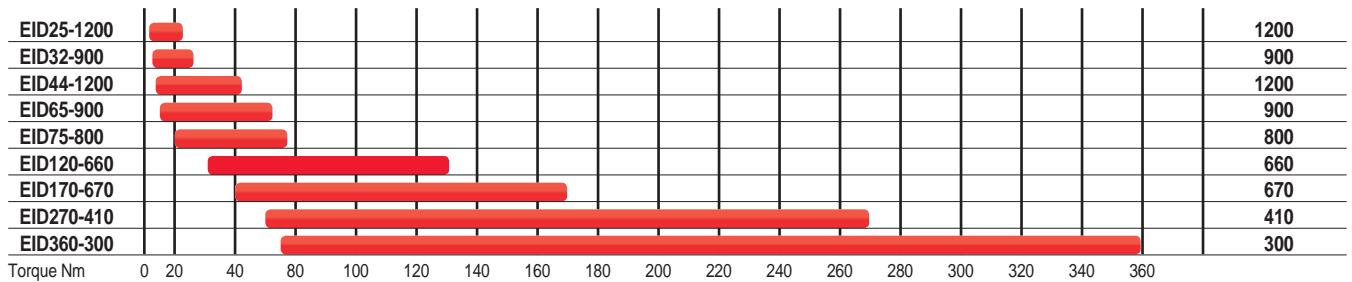

Angle head tools (EABCCom) ROTATIONAL SPEED rpm

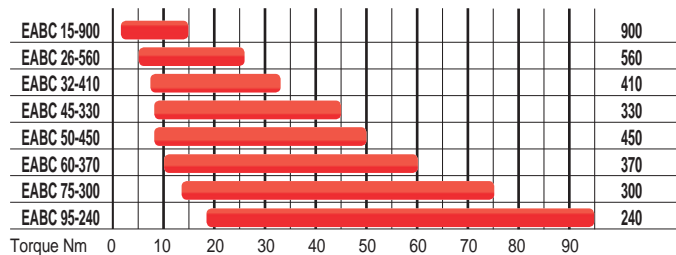

Pistol tools (ERP) ROTATIONAL SPEED rpm

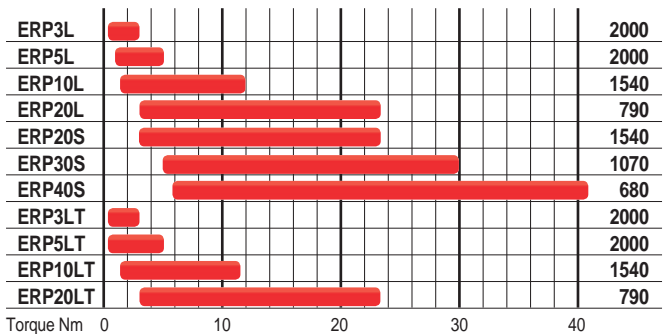

Torque Range - Fixtured electric spindles

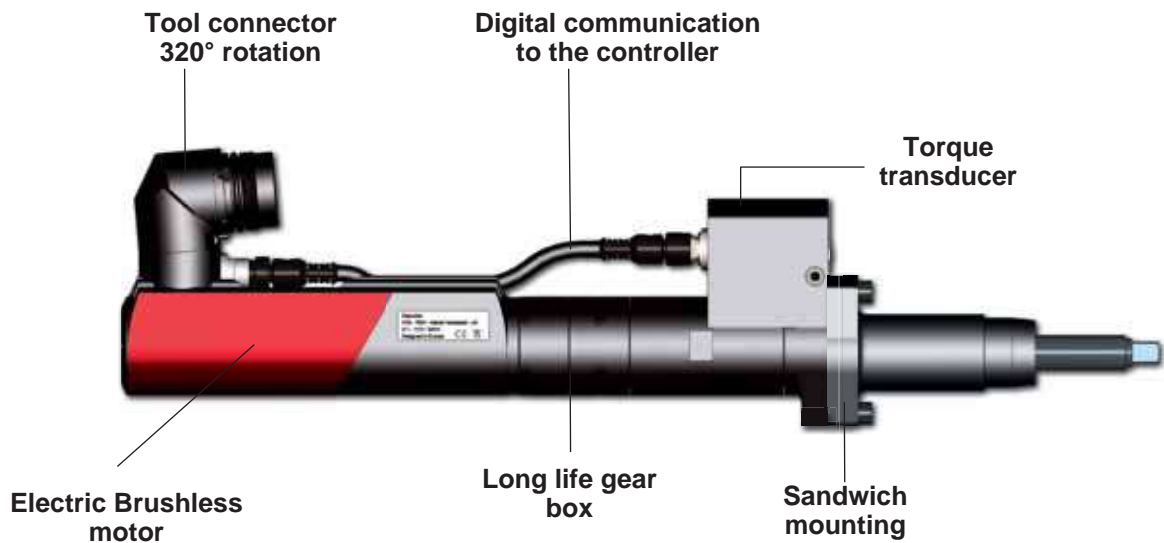

Performance of Fixtured electric spindles - Series EFDE and EFDA

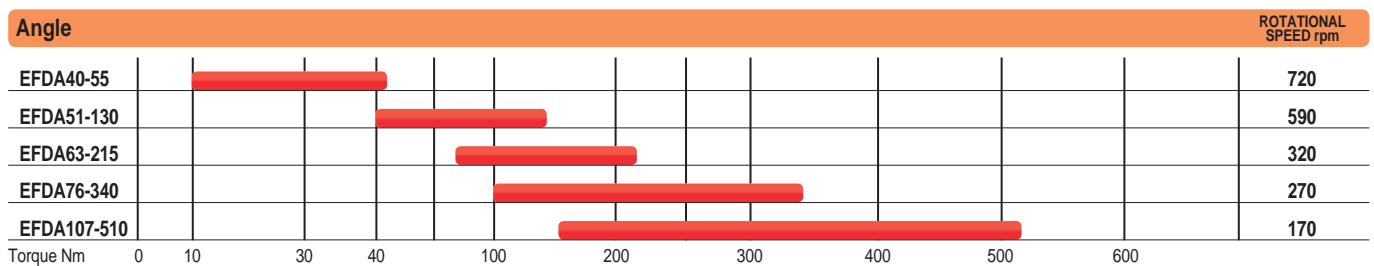
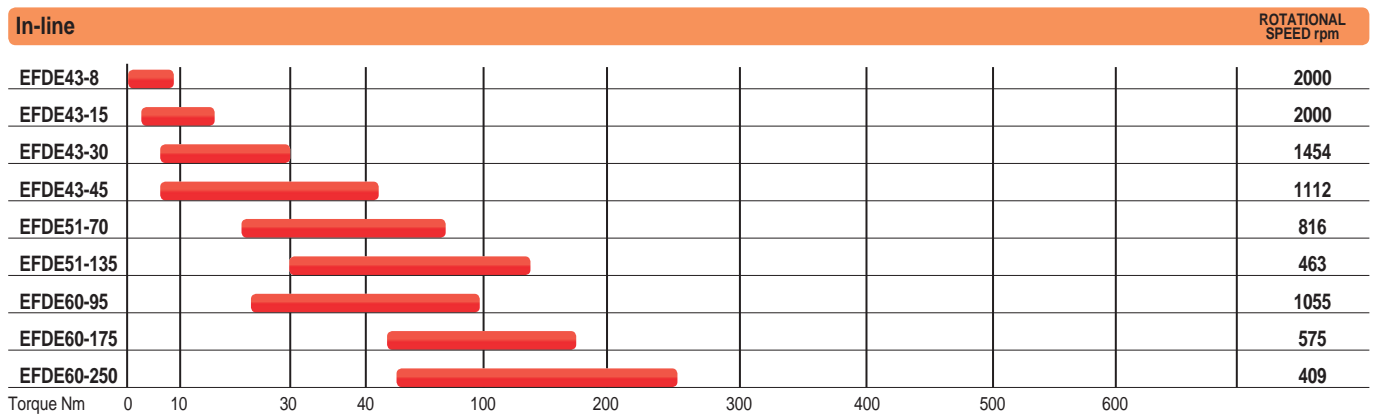

**For Higher torque,
please refer to the section EME tools (page 49)**

- EME up to 1900 Nm (1400 ft.lb)
- EME Offset up to 300 Nm (221 ft.lb)
- EMEL up to 800 Nm (590 ft.lb)

Pistol grip electric nutrunners - CVI3

0.35 to 42 Nm (0.26 to 31 ft.lb) - 680 to 2000 rpm



CVI II Adapter needed

Accessories: see pages 36-37 

PIC REF	MODEL	PART NUMBER	OUTPUT DRIVE	TORQUE						ROTATIONAL SPEED	LENGTH		WEIGHT	
				MIN.	RECOM-MENDED	MAX.	MIN.	RECOM-MENDED	MAX.		mm	in.	kg	lb.
			in.	Nm	Nm	Nm	ft.lb	ft.lb	ft.lb	rpm	mm	in.	kg	lb.
A	ERP3L	615 165 193 0	Hex. 1/4 F	0.35	3	3.3	0.26	2.2	2.4	2000	196	7.7	1.0	2.2
A	ERP5L	615 165 194 0	Hex. 1/4 F	0.5	5	5.5	0.37	3.7	4	2000	196	7.7	1.0	2.2
A	ERP10L	615 165 195 0	Hex. 1/4 F	1.5	10	12	1.1	7.4	8.8	1540	196	7.7	1.1	2.4
A	ERP20L	615 165 196 0	Hex. 1/4 F	3	20	23	2.2	14.7	17	790	196	7.7	1.1	2.4
A	ERP20S	615 165 197 0	Hex. 1/4 F	3	20	23	2.2	14.7	17	1540	221	8.7	1.2	2.6
B	ERP30S	615 165 198 0	Sq. 3/8	5	30	30	3.7	22.1	22	1070	217	8.5	1.2	2.6
C	ERP40S	615 165 263 0	Sq. 3/8	6	40	42	4.4	29.5	31	680	274	11	1.7	3.7
D	ERP3LT	615 165 227 0	Hex. 1/4 F	0.35	3	3.3	0.26	2.2	2.4	2000	196	7.7	1.0	2.2
D	ERP5LT	615 165 228 0	Hex. 1/4 F	0.5	5	5.5	0.37	3.7	4	2000	196	7.7	1.0	2.2
D	ERP10LT	615 165 229 0	Hex. 1/4 F	1.5	10	12	1.1	7.4	8.8	1540	196	7.7	1.1	2.4
D	ERP20LT	615 165 230 0	Hex. 1/4 F	3	20	23	2.2	14.7	17	790	196	7.7	1.1	2.4

Angle head electric nutrunners - CVI3

3 to 105 Nm (2.2 to 77.4 ft.lb) - 500 to 1300 rpm

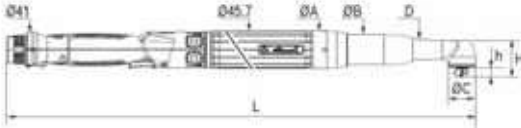

MODEL	h		H		ØA		ØB		ØC		D	
	mm	in.	mm	in.	mm	in.	mm	in.	mm	in.	mm	in.
EAD20-1300	12.0	0.47	45.5	1.79	46	1.81	37	1.46	28	1.10	25	0.98
EAD32-900	12.0	0.47	45.5	1.79	46	1.81	37	1.46	28	1.10	25	0.98
EAD50-900	12.0	0.47	51.1	2.01	46	1.81	37	1.46	35	1.38	28	1.10
EAD70-800	12.0	0.47	56.7	2.23	58	2.28	43	1.69	40	1.57	32	1.26
EAD80-650	17.5	0.69	60.4	2.38	58	2.28	48	1.89	45	1.77	40	1.57
EAD105-500	17.5	0.69	60.4	2.38	58	2.28	48	1.89	45	1.77	40	1.57

Accessories: see pages 36-37

MODEL	PART NUMBER	SQUARE DRIVE	TORQUE						ROTATIONAL SPEED	LENGTH		WEIGHT	
			MIN.	RECOM-MENDED	MAX.	MIN.	RECOM-MENDED	MAX.		mm	in.	kg	lb.
		in.	Nm	Nm	Nm	ft.lb	ft.lb	ft.lb	rpm				
EAD20-1300	615 165 606 0	3/8	3	18	20	2.2	13.3	14.8	1300	481	19.2	1.4	3.08
EAD32-900	615 165 607 0	3/8	5	30	32	3.7	22.1	23.6	900	481	19.2	1.4	3.08
EAD50-900	615 165 609 0	3/8	8	45	50	5.9	33.2	40.6	900	531	20.9	1.8	3.96
EAD70-800	615 165 611 0	3/8	12	65	70	8.9	47.9	51.6	800	544	21.4	2.0	4.40
EAD80-650	615 165 612 0	1/2	15	75	80	11.1	55.3	59	650	567	22.3	2.4	5.72
EAD105-500	615 165 613 0	1/2	20	90	105	14.8	66.4	77.4	500	567	22.3	2.4	5.72

Angle head electric nutrunners - CVI3

35 to 660 Nm (26 to 487 ft.lb) - 160 to 430 rpm

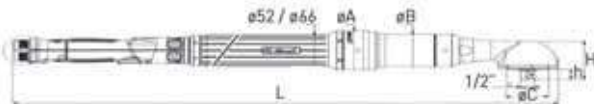

MODEL	h		H		ØA		ØB		ØC	
	mm	in.	mm	in.	mm	in.	mm	in.	mm	in.
EAD160-430	17.1	0.67	65	2.56	66	2.6	55	2.17	50	1.16
EAD200-370	23	0.91	85	3.35	66	2.6	55	2.17	62	2.44
EAD280-260	23	0.91	85	3.35	66	2.6	55	2.17	62	2.44
EAD280-370	23	0.91	85	3.35	72	2.83	55	2.17	62	2.44
EAD440-250	24	0.94	91	3.58	76	2.99	67	2.64	75	2.95
EAD660-160	33.1	1.3	110	4.33	76	2.99	67	2.64	106	4.17

Accessories: see pages 36-37

MODEL	PART NUMBER	SQUARE DRIVE	TORQUE						ROTATIONAL SPEED	LENGTH		WEIGHT	
			MIN.	RECOM-MENDED	MAX.	MIN.	RECOM-MENDED	MAX.		mm	in.	kg	lb.
		in.	Nm	Nm	Nm	ft.lb	ft.lb	ft.lb	rpm				
EAD160-430	615 165 681 0	1/2	35	150	160	26	111	118	430	650	25.6	4.3	9.5
EAD200-370	615 165 682 0	3/4	60	170	200	44	125	148	370	673	26.5	5.1	11.2
EAD280-260	615 165 683 0	3/4	60	250	280	44	184	207	260	673	26.5	5.1	11.2
EAD280-370	615 165 684 0	3/4	60	250	280	44	184	207	370	681	26.8	6.1	13.5
EAD440-250	615 165 685 0	3/4	100	400	440	74	295	325	250	735	28.9	8.4	18.5
EAD660-160	615 165 686 0	1	100	600	660	74	443	487	160	774	30.4	11.0	24.3

In-line electric nutrunners - CVI3

3 to 75 Nm (2.2 to 57.5 ft.lb) - 800 to 1200 rpm

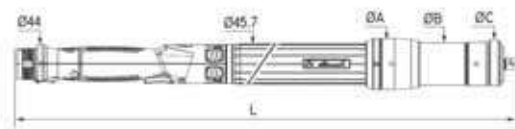

MODEL	ØA		ØB		ØC	
	mm	in.	mm	in.	mm	in.
EID25-1200	62	2.44	37	1.46	60	2.36
EID32-900	62	2.44	37	1.46	60	2.36
EID44-1200	62	2.44	48	1.89	54	2.13
EID65-900	58	2.28	48	1.89	54	2.13
EID75-800	58	2.28	48	1.89	54	2.13

Accessories: see pages 36-37 

MODEL	PART NUMBER	SQUARE DRIVE	TORQUE						ROTATIONAL SPEED	LENGTH		WEIGHT	
			MIN.	RECOM-MENDED	MAX.	MIN.	RECOM-MENDED	MAX.		mm	in.	kg	lb.
		in.	Nm	Nm	Nm	ft.lb	ft.lb	ft.lb	rpm				
EID25-1200*	615 165 614 0	3/8	3	20	25	2.2	14.8	18.4	1200	430	16.9	1.20	2.64
EID32-900*	615 165 615 0	3/8	5	30	32	3.7	22.1	25.1	900	430	16.9	1.20	2.64
EID44-1200*	615 165 616 0	3/8	7	40	44	5.2	29.5	33.2	1200	489	19.3	1.95	4.29
EID65-900	615 165 617 0	3/8	10	60	65	7.4	44.3	47.9	900	489	19.3	1.95	4.29
EID75-800	615 165 618 0	1/2	20	70	75	14.8	51.6	57.5	800	489	19.3	1.95	4.29

(*): Tools mounted with second lever start in standard

In-line electric nutrunners - CVI3

20 to 360 Nm (15 to 266 ft.lb) - 300 to 670 rpm

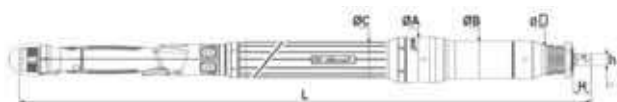

MODEL	ØA		ØB		ØC		ØD	
	mm	in.	mm	in.	mm	in.	mm	in.
EID120-660	66	2.60	55	2.17	52	2.05	42.0	1.65
EID170-670	72	2.83	55	2.17	66	2.60	42.0	1.65
EID270-410	76	2.99	67	2.64	66	2.60	53.5	2.11
EID360-300	76	2.99	67	2.64	66	2.60	53.5	2.11

Accessories: see pages 36-37 

MODEL	PART NUMBER	SQUARE DRIVE	TORQUE						ROTATIONAL SPEED	LENGTH		WEIGHT	
			MIN.	RECOM-MENDED	MAX.	MIN.	RECOM-MENDED	MAX.		mm	in.	kg	lb.
		in.	Nm	Nm	Nm	ft.lb	ft.lb	ft.lb	rpm				
EID120-660	615 165 677 0	1/2	20	110	120	15	81	89	660	583	22.9	3.3	7.3
EID170-670	615 165 678 0	1/2	40	150	170	30	111	125	670	591	23.3	4.6	10.1
EID270-410	615 165 679 0	3/4	60	250	270	44	184	199	410	625	24.6	6.1	13.5
EID360-300	615 165 680 0	3/4	70	330	360	52	243	266	300	661	26.0	6.9	15.2

Crowfoot and tube nut tools

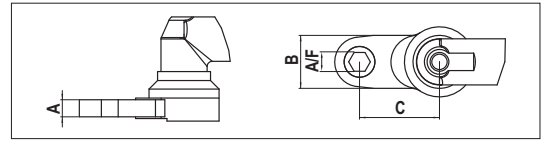

Offset Closed

MODEL	PART NUMBER	TORQUE RANGE		FREE SPEEDD	WEIGHT		DIMENSIONS									
		Nm	ft.lb		rpm	kg	lb.	AF		A		B		C		
EAD12-1300-CE10-L47-H10-W22	615 165 828 0	4-12	2.95-8.9	1300	2.1	4.6	10	0.39	10	0.39	22	0.87	65.6	2.58		
EAD18-900-CE10-L47-H15-W22	615 165 829 0	4-18	2.95-13.3	900	2.1	4.6	10	0.39	15	0.59	22	0.87	65.6	2.58		
EAD28-800-CE13-L62-H15-W30	615 165 832 0	7-28	5.2-20.7	800	2.5	5.5	13	0.51	15	0.59	30	1.18	84.0	3.31		
EAD44-800-CE14-L71-H18-W31	615 165 833 0	8-44	5.9-32.5	800	2.6	5.7	14	0.50	18	0.71	31	1.22	93.6	3.68		
EAD65-500-CE17-L78-H24-W30	615 165 834 0	14-65	10.3-47.9	500	3.0	6.6	17	0.67	24	0.94	30	1.18	102	4.02		

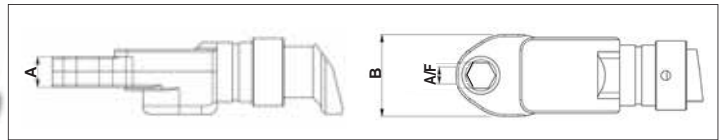

In line Closed

MODEL	PART NUMBER	TORQUE RANGE		FREE SPEEDD	WEIGHT		DIMENSIONS									
		Nm	ft.lb		rpm	kg	lb.	AF		A		B				
EID28-660-CE13-L45-H15-W30	615 165 837 0	6-28	4.4-20.7	660	1.9	4.2	13	0.51	15	0.59	30	1.18				

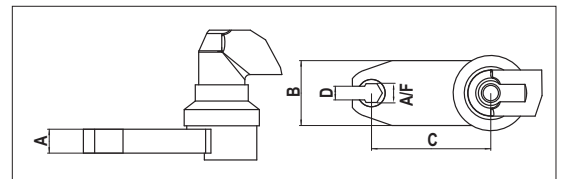

Offset Open

Double start

MODEL	PART NUMBER	TORQUE RANGE		FREE SPEEDD	WEIGHT		DIMENSIONS									
		Nm	ft.lb		rpm	kg	lb.	AF		A		B		C		D
EAD15-900-OE12-L44-H12-W32	615 165 830 0	4-15	2.95-11.1	900	2.1	4.6	12	0.47	12	0.47	32	1.26	62.8	2.47	8	0.31
EAD18-900-OE13-L51-H11-W38	615 165 831 0	4-18	2.95-13.3	900	2.2	4.9	13	0.51	11	0.43	38	1.49	73	2.87	8	0.31

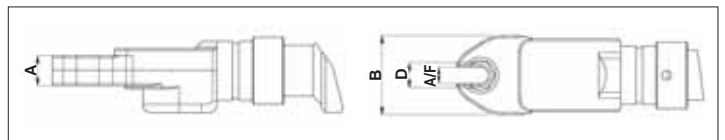
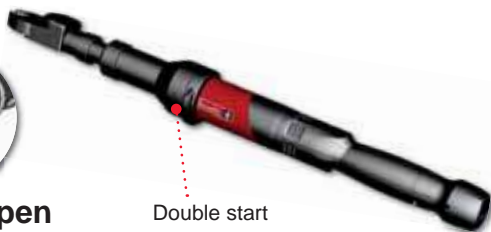

In line Open

Double start

MODEL	PART NUMBER	TORQUE RANGE		FREE SPEEDD	WEIGHT		DIMENSIONS									
		Nm	ft.lb		rpm	kg	lb.	AF		A		B		D		
EID20-900-OE12-L31-H14-W38	615 165 835 0	4-20	2.95-14.8	900	1.9	4.2	12	0.47	14	0.55	38	1.49	8	0.31		
EID28-660-OE14-L34-H18-W40	615 165 836 0	6-28	4.4-20.7	660	1.9	4.2	14	0.55	18	0.71	40	1.57	10.4	0.41		



Contact your Desoutter representative for assistance in specifying the correct head for your application. We can supply standard products or, if the application requires, we can also provide customized tools.

Wireless transducerized battery tool - EABcom



Advance Process control

- Full traceability with CVI3 Vision
- Real time data collection
- CVI CONFIG manager, assembly process, advance tightening strategies

User friendly interface

- Operator feedback with the OLED color display on tool
- Embedded barcode reader (option)
- Oil and dust proof trigger with a patent pending "non-contact trigger"

Easy integration

- Rebalancing: up to 10 tools connected to one CVI3 controller
- Fully compliant with existing CVI 3 Vision controller and accessories
- WIFI 2.4 / 5Ghz wireless communication

Flexibility

- Connected and disconnected possibility
- Long life with a 36 Volt Li-ion battery technology
- Restricted area usage with localisation possibility

Check with your local Desoutter representative regarding availability on your market

EABcom Series

3 to 95 Nm (2.2 to 70 ft.lb) - 10 to 900 rpm



A



B



C

MODEL	L		h		H		øA		øB	
	mm	in.	mm	in.	mm	in.	mm	in.	mm	in.
EABC 15-900	470	18.5	10.2	0.40	33.8	1.33	22	0.87	37.0	1.46
EABC 26-560	496	19.5	12.0	0.47	45.7	1.80	28	1.10	37.0	1.46
EABC 32-410	496	19.5	12.0	0.47	45.7	1.80	28	1.10	37.0	1.46
EABC 45-330	506	19.9	12.0	0.47	51.0	2.00	35	1.38	37.0	1.46
EABC 50-450	546	21.5	12.0	0.47	51.0	2.00	35	1.38	37.0	1.46
EABC 60-370	559	22.0	11.9	0.468	57.0	2.20	40	1.57	41.0	1.61
EABC 75-300	582	22.9	17.5	0.69	60.4	2.38	45	1.77	48.5	1.91
EABC 95-240	582	22.9	17.5	0.69	60.4	2.38	45	1.77	48.5	1.91

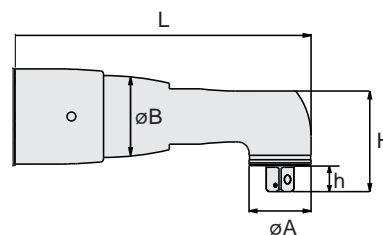

Accessories: see page 36

PIC REF	MODEL	PART NUMBER	SQUARE DRIVE	TORQUE RANGE						ROTATIONAL SPEED	WEIGHT WITHOUT BATTERY		VOLTAGE
				MIN.	RECOM-MENDED	MAX.	MIN.	RECOM-MENDED	MAX.		kg	lb	
			in.	Nm	Nm	Nm	ft.lb	ft.lb	ft.lb	rpm			V
EABcom - TRANSDUCERIZED BATTERY TOOL													
A	EABC 15-900	615 165 841 0	1/4	3	13	15	2.2	9.6	11	900	1.55	3.42	36
B	EABC 26-560	615 165 842 0	3/8	5	24	26	3.7	18	19	560	1.65	3.64	36
B	EABC 32-410	615 165 843 0	3/8	7	30	32	5.2	22	24	410	1.65	3.64	36
B	EABC 45-330	615 165 844 0	3/8	9	40	45	6.6	30	33	330	1.76	3.88	36
B	EABC 50-450	615 165 845 0	3/8	9	45	50	6.6	33	37	450	2.04	4.50	36
B	EABC 60-370	615 165 846 0	3/8	10	55	60	7.4	41	44	370	2.35	5.18	36
B	EABC 75-300	615 165 847 0	1/2	12	70	75	8.8	52	55	300	2.94	6.48	36
C	EABC 95-240	615 165 848 0	1/2	19	90	95	14	66	70	240	2.98	6.57	36

Battery not included

Fixtured electric spindles - CVI3

1 to 280 Nm (0.7 to 206 ft.lb) - 409 to 2000 rpm

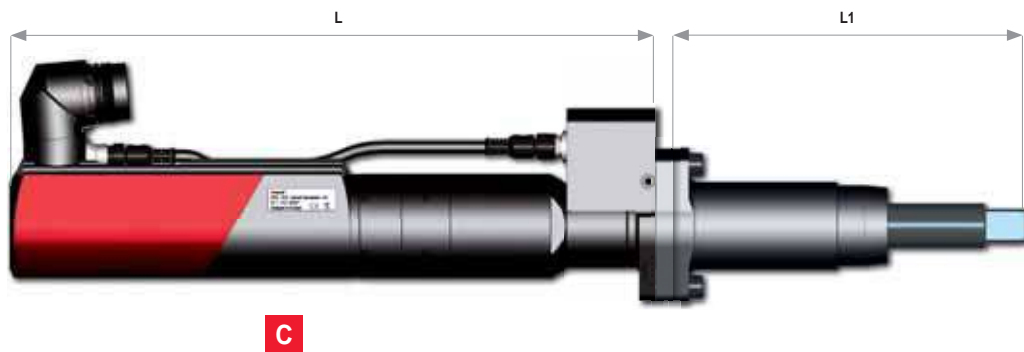
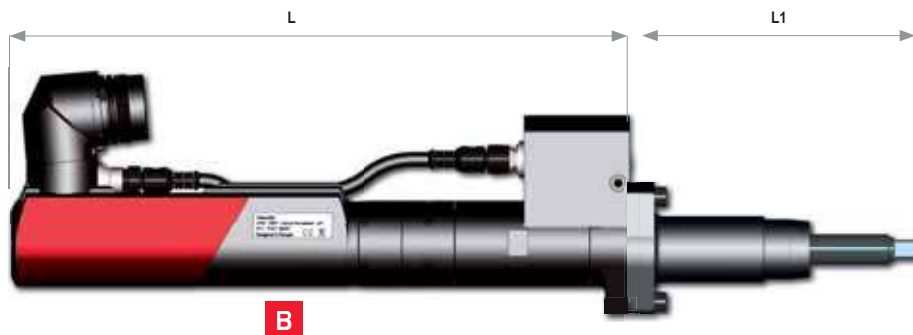
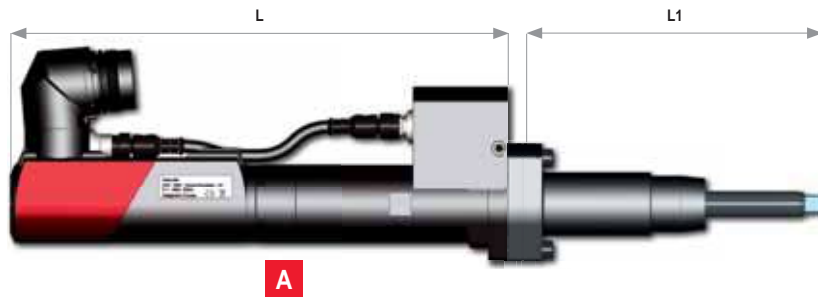

MODEL	LENGTH				WEIGHT			
	TOOL-L		MODULE-L1		TOOL		MODULE	
	mm	in.	mm	in.	kg	lb.	kg	lb.
EFDE 43-8	276	10.9	165	6.5	2.1	4.63	0.65	1.43
EFDE 43-15	276	10.9	165	6.5	2.1	4.63	0.65	1.43
EFDE 43-30	311	12.2	165	6.5	2.3	5.07	0.65	1.43
EFDE 43-45	311	12.2	165	6.5	2.3	5.07	0.65	1.43
EFDE 51-70	357	14.0	183	7.2	3.9	8.60	1.45	3.20
EFDE 51-135	357	14.0	183	7.2	3.9	8.60	1.45	3.20
EFDE 60-95	373	14.7	183	7.2	5.3	11.7	1.45	3.20
EFDE 60-175	373	14.7	203	8.0	5.3	11.7	1.87	4.12
EFDE 60-250	373	14.7	203	8.0	5.3	11.7	1.87	4.12

Accessories: see page 36

PIC REF	MODEL	PART NUMBER	SQUARE DRIVE	TORQUE						ROTATIONAL SPEED	TELESCOPIC		MIN.CENTRE DISTANCE	
				MIN.	RECOM-MENDED	MAX.	MIN.	RECOM-MENDED	MAX.		mm	in.	mm	in.
			In.	Nm	Nm	Nm	ft.lb	ft.lb	ft.lb	rpm	mm	in.	mm	in.
A	EFDE 43-8	615 165 864 0	3/8	1	8	10	0.7	5.9	7.4	2000	50	1.97	43	1.69
A	EFDE 43-15	615 165 865 0	3/8	3	15	17	2.2	11.1	12.5	2000	50	1.97	43	1.69
A	EFDE 43-30	615 165 866 0	3/8	7	30	32	5.2	22.1	23.6	1454	50	1.97	43	1.69
A	EFDE 43-45	615 165 867 0	3/8	7	45	50	5.2	33.2	36.9	1112	50	1.97	43	1.69
B	EFDE 51-70	615 165 868 0	1/2	20	70	80	14.7	51.6	59	816	50	1.97	51	2.01
B	EFDE 51-135	615 165 869 0	1/2	30	135	150	22.1	99.6	111	463	50	1.97	51	2.01
B	EFDE 60-95	615 165 870 0	1/2	22	95	105	16.2	70.1	77.4	1055	50	1.97	60	2.36
C	EFDE 60-175	615 165 871 0	3/4	50	175	190	36.9	129	140	575	50	1.97	60	2.36
C	EFDE 60-250	615 165 872 0	3/4	55	250	280	40.6	184	206	409	50	1.97	60	2.36

Fixtured electric spindles - CVI3

12 to 580 Nm (8.8 to 428 ft.lb) - 170 to 720 rpm

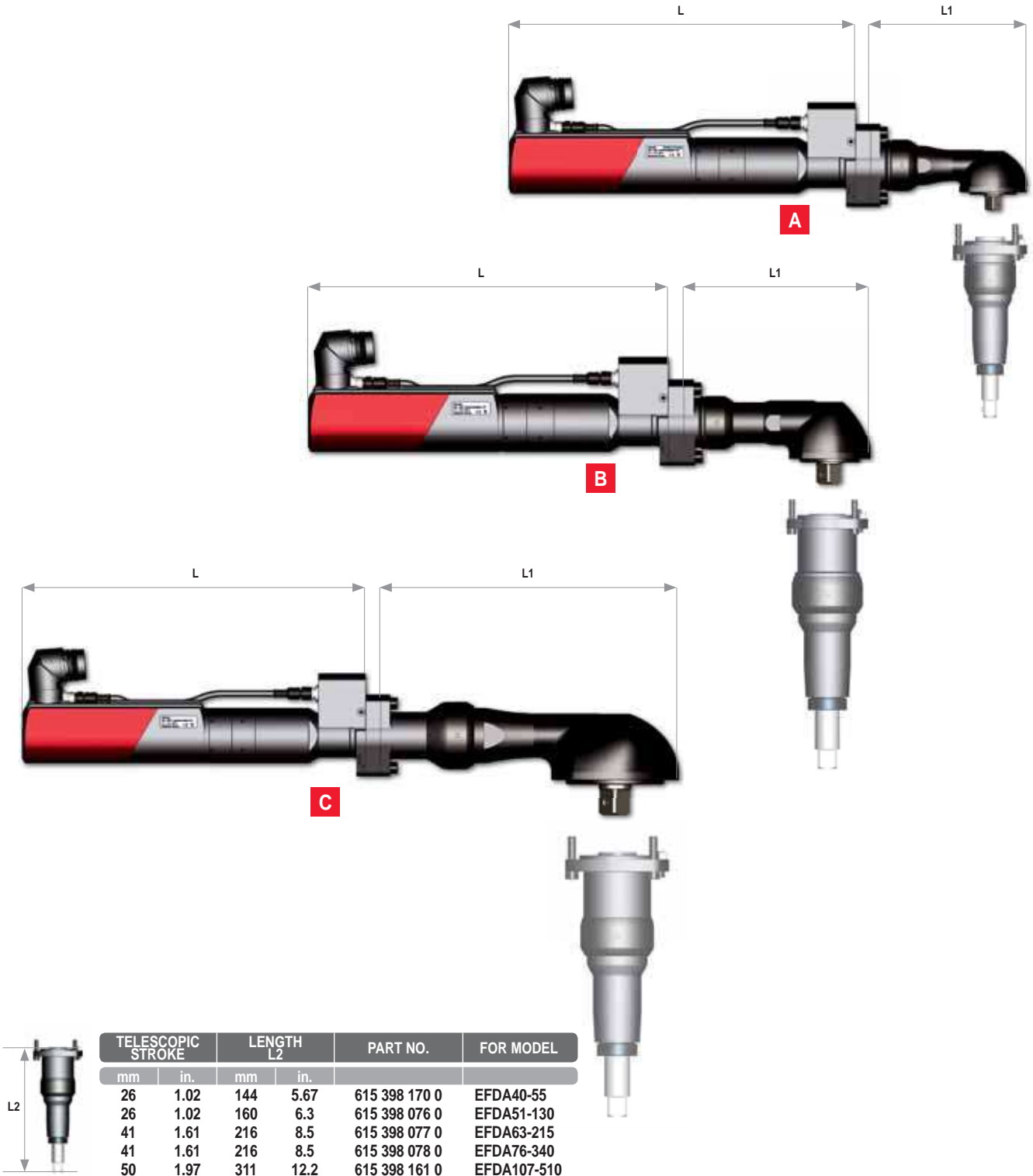

TELESCOPIC STROKE		LENGTH L2		PART NO.	FOR MODEL
mm	in.	mm	in.		
26	1.02	144	5.67	615 398 170 0	EFDA40-55
26	1.02	160	6.3	615 398 076 0	EFDA51-130
41	1.61	216	8.5	615 398 077 0	EFDA63-215
41	1.61	216	8.5	615 398 078 0	EFDA76-340
50	1.97	311	12.2	615 398 161 0	EFDA107-510

Accessories: see page 36

PIC REF	MODEL	PART NUMBER	SQUARE DRIVE	TORQUE						ROTATIONAL SPEED	MIN.CENTRE DISTANCE		LENGTH				WEIGHT	
				MIN.	RECOM-MENDED	MAX.	MIN.	RECOM-MENDED	MAX.		mm	in.	TOOL	ANGLE HEAD		kg	lb.	
			in.	Nm	Nm	Nm	ft.lb	ft.lb	ft.lb	rpm	mm	in.	mm	in.	mm	in.	kg	lb.
A	EFDA40-55	615 165 858 0	3/8	12	55	65	8.8	40.1	47.9	720	40	1.57	311	12.2	196	7.7	3.7	8.1
B	EFDA51-130	615 165 859 0	1/2	45	130	150	33.2	95.9	114	590	51	2.01	373	14.7	166	6.5	7.2	15.8
B	EFDA63-215	615 165 860 0	3/4	80	215	250	59	158.6	184	320	63	2.48	373	14.7	189	7.4	8.1	17.8
B	EFDA76-340	615 165 861 0	3/4	100	340	380	73.7	240	280	270	76	2.99	373	14.7	282	11.1	9.7	21.3
C	EFDA107-510	615 165 862 0	1	150	510	580	110.6	376	428	170	107	4.21	373	14.7	320	12.6	12.4	27.3

Accessories

Cable for ERP / EAD / EID / EFDE / EFDA

Cable for ERP tools	PART NO.
Nutranner cable 2.5m (8.2ft)	615 917 570 0
Nutranner 5m (16ft)	615 917 492 0
Nutranner 10m (32.8ft)	615 917 494 0
Nutranner 15m (49.2ft)	615 917 495 0

Cable for EAD & EID tools	PART NO.
Tool cable 2.5m (8.2ft)	615 917 601 0
Tool cable 5m (16ft)	615 917 602 0
Tool cable 10m (32.8ft)	615 917 604 0
Tool cable 15m (49.2ft)	615 917 605 0
Tool cable eFLEX 2.5m (8.2ft)*	615 917 631 0
Tool cable eFLEX 5m (16.4ft)*	615 917 632 0



*Check with your local Desoutter representative regarding availability on your market

Cable for EFDE & EFDA tools	PART NO.
Tool cable 2.5m (8.2ft)	615 917 651 0
Tool cable 5m (16ft)	615 917 652 0
Tool cable 10m (32.8ft)	615 917 654 0
Tool cable 15m (49.2ft)	615 917 655 0



Telescopic module for EFDE tools		PART NO.	FOR MODEL
STROKE			
mm	in.		
50	1.97	615 397 013 0	EFDE43-8 to EFDE43-45
50	1.97	615 397 017 0	EFDE51-70 to EFDE60-95
50	1.97	615 397 014 0	EFDE60-175 to EFDE60-250
60	2.36	615 397 015 0	EFDE60-175 to EFDE60-250

Extension cable for ERP tools	PART NO.
Extension cable 5m (16ft)	615 917 083 0
Extension cable 10m (32.8ft)	615 917 084 0
Extension cable 15m (49.2ft)	615 917 085 0
Extension cable 20m (65.6ft)	615 917 086 0
Extension cable 25m (82ft)	615 917 087 0
Extension cable 30m (98ft)	615 917 088 0

Extension cable for EAD - EID - EFDE & EFDA tools	PART NO.
Ext. cable 8m (26.2ft)	615 917 581 0
Ext. cable 16m (52.5ft)	615 917 584 0
Ext. cable 32m (105ft)	615 917 587 0
Ext. cable 50m (164ft)	615 917 589 0



eBUS cable	PART NO.
eBUS cable 1m (3.3ft)	615 917 621 0
eBUS cable 3m (9.9ft)	615 917 622 0
eBUS cable 5m (16.4ft)	615 917 623 0
eBUS cable 15m (49.2ft)	615 917 624 0
eBUS Termination plug	615 917 625 0



Transducer holders for EFDE tools	PART NO.
3/8" Square drive EFDE43	615 396 426 0
1/2" Square drive EFDE51/60-95	615 396 427 0
3/4" Square drive EFDE60-175/250	615 396 428 0

EABcom



OPTIONAL ACCESSORIES	PART NO.
Battery type	
1 Li-ion Battery 36V 1.3 Ah - 0.60 kg (1.32lb)	615 396 750 0
Chargers	
2 Charger for Li-ion 230V - Europe - 36V	615 811 397 0
2 Charger for Li-ion 120V - USA - 36V	615 811 398 0
2 Charger for Li-ion 230V - UK - 36V	615 811 399 0
Miscellaneous	
3 Angle head protection 15Nm	615 211 003 0
3 Angle head protection 26/32Nm	615 573 207 0
3 Angle head protection 45Nm/50Nm	615 573 208 0
3 Angle head protection 60Nm	615 573 209 0
3 Angle head protection 75Nm/95Nm	615 573 210 0
4 eDOCK	615 811 976 0
• Barcode reader - Tool module	615 811 896 0
5 DTH TWIN (single) without rail	615 811 411 0
6 DTH TWIN rail kit with 2 Twin holders	615 811 412 5
7 DTH TWIN stand kit with base & 2 Twin holders	615 811 413 5
8 Access point Wifi7 802.11N-US:	615 811 419 5
8 Access point Wifi7 802.11N-EU:	615 811 417 5
- Plug UK	615 917 202 0

Accessories



CVI3 Controllers

OPTIONAL ACCESSORIES

ITEM	PART NO.
Controllers	
1 Socket tray - 4 positions	615 936 071 0
2 Kit tubes & Inserts for Socket tray	615 398 035 5
3 Bit holder module for Socket tray	615 398 083 5
4 Operator Panel (advanced)	615 936 072 0
5 Stack Light	615 936 073 0
6 I/O Expander	615 936 074 0
• Y cable for RS232 port	615 917 620 0

ERP / EAD / EID

OPTIONAL ACCESSORIES

ITEM	PART NO.
------	----------

Tools

7 Suspension bail - non swivelling - All tools up to EAD105/EID75	615 397 412 0
8 Suspension bail - swivelling - All tools up to EAD105/EID75	615 397 413 0
8 Suspension bail - swivelling - for tools EAD160/200/280-260 & EID120	615 571 072 0
9 Front trigger - mechanical kit for tools EAD20 to EAD105 & EID25 to EID75	615 397 812 5
(must be mounted on tool by authorized Desoutter service technician)	
9 Front trigger - electric kit for EAD20 to EAD32 & EID25 to EID32	615 911 013 5
9 Front trigger - electric kit for EAD50 to EAD105 & EID44 to EID75	615 911 012 5
10 Telescopic output 3/8" for EID25/32	615 397 811 0
10 Telescopic output 1/2" for EID44	615 398 078 0
10 Telescopic output 1/2" for EID65/75	615 398 079 0
10 Telescopic output 1/2" for EID120/170	615 398 080 0
10 Telescopic output 3/4" for EID270/300	615 398 081 0
11 Telescopic output 1/2" for EAD160	615 398 076 0
11 Telescopic output 3/4" for EAD200/280	615 398 077 0
11 Telescopic output 3/4" for EAD440	615 398 078 0
11 Telescopic output 1" for EAD660	615 398 161 0
12 Handle lever	615 397 831 0
13 Angle head protection EAD20/32	615 573 207 0
13 Angle head protection EAD50	615 573 208 0
13 Angle head protection EAD70	615 573 209 0
13 Angle head protection EAD80/105	615 573 210 0
14 Angle head protection EID25/32	615 573 211 0
14 Angle head protection EID44/65/75	615 573 212 0
15 Finger Protection EAD20/32	615 397 635 0
15 Finger Protection EAD50	615 397 636 0
15 Finger Protection EAD70	615 397 637 0
16 Trigger locker	615 397 842 0
• Barcode reader -- Tool module - EAD/EID	615 811 896 0
• Mounting plate for custom arm - EAD160/200/280/440/660	Contact Desoutter

Desoutter Tool Holster

17 DTH42 (For ERP3/5/10/20/30)	107892
18 DTH TWIN (single) without rail	615 811 411 0
19 DTH TWIN rail kit with 2 Twin holders	615 811 412 5
20 DTH TWIN stand kit with base & 2 Twin holders	615 811 413 5

Other accessories

• D53 arms	See Pages 136-140
• TRA telescopic reaction arms	See Page 141
• Balancers	See Page 146

Adapter for ERAL/ERDL/ERP and EME

	PART NO.
CVI II Adapter	615 936 070 0



Programming and Data collection software

CVI CONFIG - programming (including CVI MONITOR)



CVIKEY - Access Level Management



Features

CVI CONFIG to set your systems point to point or via network with an intuitive and guided interface

User-friendly interface

- Easy setting with Quick Pset & learning mode
- Fast learning curve with contextual help
- Complete Assembly line view in the tree area
- Intuitive Pset setting with curve templates

Advanced process control

- Error-proofed with real time consistency check
- Complete process logic mapping including tightening & non-tightening operations with Assembly process

High flexibility

- Dynamic mapping for I/O, fieldbus with Drag & drop function
- 2 ways transfer of all parameters between stations & PC
- Real time access to tool parameters/counters (partial/total number of cycles performed by the tool/cable)
- Test mode to check torque transducer, angle encoder, brushless motor
- Complete backup/restore of stations

CVI MONITOR included in CVI CONFIG for real-time monitoring of the assembly line

Real-time process monitoring

- Results
- Curves
- Statistics

Real-time maintenance monitoring

- I/O status
- Counters (controller, tool, cable)
- Realtime monitoring of the FieldBus

Troubleshooting

- Alarms history (logs)
- Problem solving guidance

CVIKEY to create & manage tailor-made access rights per user profile

Tailor made protection

- Intuitive software to create/manage access level
- Protection guaranteed by unique profile keys created by the administrator (locked against copy)

Simple interface

- Plug&Play USB key
- 4 profiles already available by default

High flexibility

- Unlimited number of profiles
- Set up the right access level for the right

Access control and real time Monitoring Software

CVI ANALYZER - Tightening Data Analyses



CVINET WEB - Data Collection



Easy Control
Ethernet connection manager

100% Traceability

3D Curves screen, display of one or several curves



Features

CVI ANALYZER to analyze & import/export tightening data with results, curves, filters, profiles Tailor made protection

Flexibility

- Complete Factory and Assembly line layout definition
- Multi User Profiles definition

Full Traceability

- Unlimited CVI3 results and curves collection, including data import from USB
- Advanced results multi-filtering
- Complete back-up solution

Statistical Analysis

- Complete back-up solution
- OK/NOK distribution
- NOK distribution reasons analysis

CVINET WEB to collect & store 100% tightening data in real-time database with advanced analytics via a web based software in service mode

Real time data collection

- Overview of all controllers connected
- View and collect in real time tightening results and curves, including assembly process results

Real time quality control of the network

- Real time tightening error messages
- Alarm in case of disconnection and FIFO inside controllers
- Automatic uploading of missing data from Controller
- View of maintenance information
- The display of one or more curves allows you to analyse and make tightening comparisons

Flexibility

- Multi-user interface with multi profiles and filters, including Team management
- Administrator profile
- Complete Plant layout definition
- CVINET WEB saves more than 40 parameters plus the results at the end of each tightening

Statistical Analysis

- Advanced OK/NOK reports and control charts
- Cm/Cmk analysis according different standards (ISO, CNOMO, NF)
- Advanced filter function for each report

Full Traceability

- Full data storage in customer server
- All results with Identification Number can be exported to another database for long time saving

Printing report

- Printing of all tightening of a vehicle or a component by scanning the bar code number



Transducerized Tools

Handheld Tools

- Brushless AC motor: virtually maintenance free
- Resolver: smooth angle control at any speed
- 6 leds OK / NOK signals

Fixtured electric spindles

- Long life gear boxes
- Brushless motor
- High output torque transducer for a larger torque range



Controllers



Communication

CVIPC2000 software is a user friendly tool able to program tightening cycles, collect and display results and curves from all Desoutter tightening controllers

CVINET WEB to collect & store 100% tightening data in real-time database with advanced analytics via a web based software in service mode

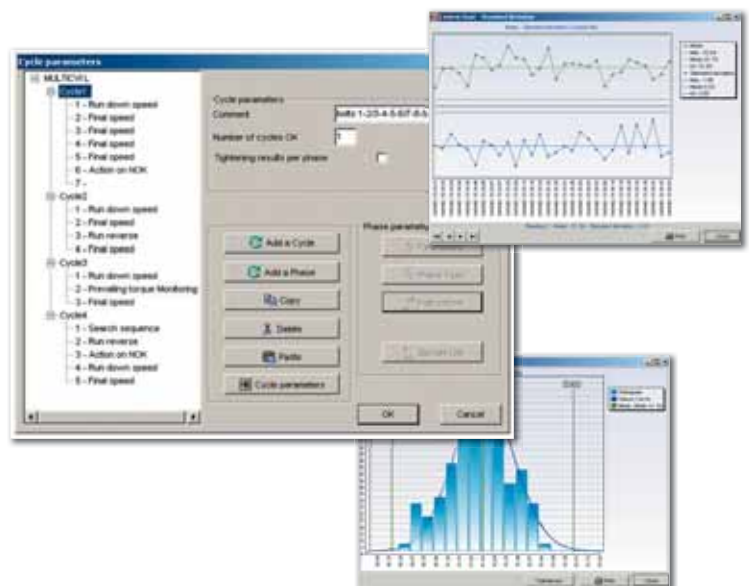

Controller - CVIR II

Error proofing and flexibility

Advanced control unit with flexibility and technology

- Easy integration into your assembly line with multiple choices of connectivity

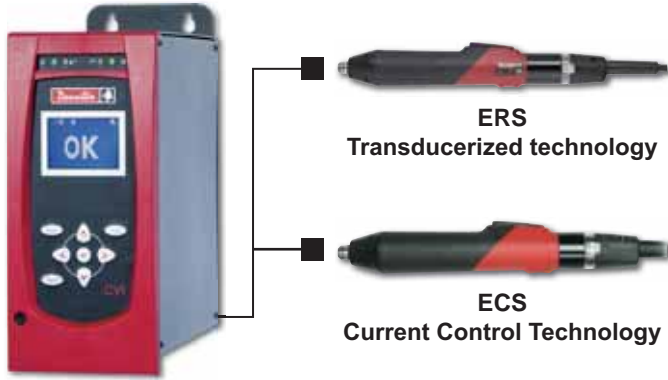

COMMUNICATION

- 1 Ethernet port for CVIPC or network communication
- 1 RS232 port to connect barcode readers or CVIPC 2000
- 8 Inputs and 8 Outputs
- 1 Optional fieldbus module

Innovative Tightening Strategy

Seating detection

Detect the screw head contact on your part by torque rate management, even with material variation

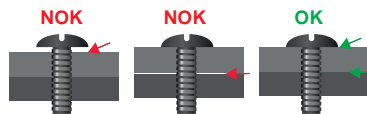

QUALITY GUARANTEED

MAIN FUNCTIONS	CVIR II
Programming modes	
Quick cycle	✓
Learning mode.....	✓
Number of cycles.....	50
Number of phases available.....	15
Phase characteristics	
Search sequence.....	✓
Approach	✓
Run down speed.....	✓
Final speed phase	✓
Action on NOK.....	✓
Run reverse.....	✓
Jump to another phase.....	✓
Prevailing Torque.....	✓
Synchronisation phase	✓
Tightening strategies	
Torque.....	✓
Torque with angle monitoring.....	✓
Angle with torque monitoring.....	✓
Yield point.....	✓
Seating detection.....	✓
Number of stored results	2000 to 10000 according configuration

MODEL	PART NUMBER	TOOLS	CONSUMPTION (CURRENT)		MAINS SUPPLY	WIDTH		DIMENSIONS HEIGHT		DEPTH		WEIGHT	
			115 V	230 V		mm	in.	mm	in.	mm	in.	kg	lb.
CVIR II	615 932 681 0	ERS/ECS	4A	2A	50/60 hertz	130	5.1	278	10.9	291	11.5	5	11

Software, Upgrade kits...

POWER CORD

to be ordered with the controller

PLUG	DESCRIPTION	PART NO.
A	European	615 917 201 0
B	US	615 917 203 0
C	UK	615 917 202 0
D	Chinese	615 917 206 0



OPTIONAL ACCESSORIES

	PART NO.
• PC cable length 2 m (78.7")	615 917 047 0
• 37 pin D-Sub female I/O adapter	615 919 003 0
• Shelf support - Aluminium profile	615 397 403 5

Software

MODEL	PART NO.
CVI PC2000-STD 1 install	615 927 522 0
CVI PC2000 advance 1 install	615 927 523 0
CVI-net 1 controller	615 927 555 0
Open Protocol 5 licences	615 927 581 0

Fieldbus / Protocol

MODEL	PART NO.
Ethernet IP Module	615 927 594 0
Profibus DP Module	615 927 595 0
Profi net Module	615 927 596 0
Devicenet Module	615 927 599 0
MODBUS TCP Slave	615 927 615 0

Electric transducerized screwdrivers - CVIR II

0.6 to 12 Nm (5.3 to 106.2 in.lbs) – 950 to 3000 rpm

The transducerized screwdrivers range ERS is dedicated for all type of tightening which required accuracy and traceability



A



B



C

Visible & Programmable reporting LED System



Good Report



Bad Report



Programmable

Tool Ready, Tool in Cycle, Maintenance Alert, and more.

Accessories: see page 51



PIC REF	MODEL	PART NUMBER	OUTPUT HEX	TORQUE				SPEED	WEIGHT	
				MIN.	MAX.	MIN.	MAX.		kg	lb.
			in.	Nm	Nm	ft.lb	ft.lb	rpm		
A	ERS2	615 165 688 0	1/4	0.6	2.5	5.3	22.1	3000	0.7	1.54
A	ERS6	615 165 689 0	1/4	1.0	6.0	8.8	53.1	1725	0.7	1.54
A	ERS12	615 165 690 0	1/4	1.5	12	13.3	106.2	950	0.7	1.54
A	ERS2-M20	615 165 691 0	1/4	0.6	2.5	5.3	22.1	3000	0.7	1.54
A	ERS6-M20	615 165 692 0	1/4	1.0	6.0	8.8	53.1	1725	0.7	1.54
A	ERS12-M20	615 165 693 0	1/4	1.5	12	13.3	106.2	950	0.7	1.54
B	ERSA-2	615 165 697 0	1/4	0.6	2.5	5.3	22.1	2500	1.0	2.2
B	ERSA-6	615 165 698 0	1/4	1.0	6.0	8.8	53.1	1450	1.0	2.2
B	ERSA-12	615 165 699 0	1/4	2.0	12	17.7	106.2	800	1.0	2.2
C	ERSF-2	615 165 694 0	1/4	0.6	2.5	5.3	22.1	3000	0.7	1.54
C	ERSF-6	615 165 695 0	1/4	1.0	6.0	8.8	53.1	1725	0.7	1.54
C	ERSF-12	615 165 696 0	1/4	1.5	12	13.3	106.2	950	0.7	1.54

Controller - CVIL II

Flexible integration

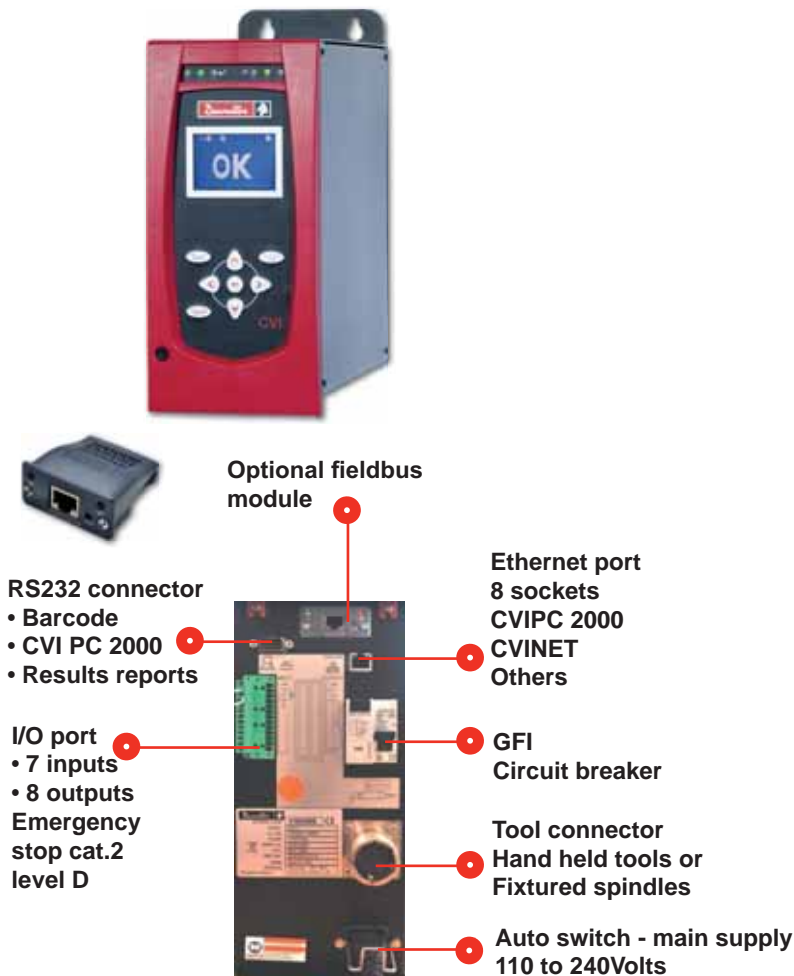

MAIN FUNCTIONS	CVIL II
Number of channels	1
Number of cycles	50
Number of phases	15
Batch count	999
Bar code reading via RS232 port	
Tightening results	
Batch count + Angle + Date + Time + Report + VIN number up to 10 000	
Number of curves (flexibility with OK and NOK).... 10	
Tightening strategies	
Torque control + angle monitoring	✓
Angle control + torque monitoring	✓
Stall torque	✓
Prevailing torque, self tapping	✓
Seating detection (option).....	✓
Current monitoring	✓
Reverse at angle control	✓

MODEL	PART NUMBER	CONSUMPTION (CURRENT)		MAINS SUPPLY	WIDTH		DIMENSIONS HEIGHT		DEPTH		WEIGHT	
		115V	230V		mm	in.	mm	in.	mm	in.	kg	lb.
CVIL II	615 932 680 0	4A	2A	Single phase	130	5.1	278	10.9	291	11.5	5.9	13

Software, Upgrade kits...

POWER CORD to be ordered with the controller

PLUG	DESCRIPTION	PART NO.
A	European	615 917 201 0
B	US	615 917 203 0
C	UK	615 917 202 0
D	Chinese	615 917 206 0

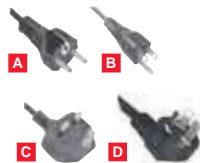

OPTIONAL ACCESSORIES

	PART NO.
• PC cable length 2 m (78.7")	615 917 047 0
• 37 pin D-Sub female I/O adapter	615 919 003 0
• Shelf support - Aluminium profile	615 397 403 5

Software

MODEL	PART NO.
CVI PC2000-STD 1 install	615 927 522 0
CVI PC2000 advance 1 install	615 927 523 0
CVI-net 1 controller	615 927 555 0
Open Protocol 5 licences	615 927 581 0

Fieldbus / Protocol

MODEL	PART NO.
Ethernet IP Module	615 927 594 0
Profibus DP Module	615 927 595 0
Profi net Module	615 927 596 0
Devicenet Module	615 927 599 0
MODBUS TCP Slave	615 927 615 0

Handheld electric tools

Pistol grip electric nutrunners

MODEL	PART NUMBER	OUTPUT DRIVE	TORQUE						ROTATIONAL SPEED	LENGTH	
			MIN.	RECOM MENDED	MAX.	MIN.	RECOM MENDED	MAX.		mm	in.
		in.	Nm	Nm	Nm	ft.lb	ft.lb	ft.lb	rpm		
ERP3L	615 165 193 0	Hex. 1/4 F	0.35	3	3.3	0.26	2.2	2.4	2000	196	7.7
ERP5L	615 165 194 0	Hex. 1/4 F	0.5	5	5.5	0.37	3.7	4.0	2000	196	7.7
ERP10L	615 165 195 0	Hex. 1/4 F	1.5	10	12	1.1	7.4	8.8	1540	196	7.7
ERP20L	615 165 196 0	Hex. 1/4 F	3.0	20	23	2.2	14.7	17	790	196	7.7
ERP20S	615 165 197 0	Hex. 1/4 F	3.0	20	23	2.2	14.7	17	1540	221	8.7
ERP30S	615 165 198 0	Sq. 3/8	5.0	30	30	3.7	22.1	22	1070	217	8.5
ERP40S	615 165 263 0	Sq. 3/8	6.0	40	42	4.4	29.5	31	680	274	10.8
ERP3LT	615 165 227 0	Hex. 1/4 F	0.35	3	3.3	0.26	2.2	2.4	2000	196	7.7
ERP5LT	615 165 228 0	Hex. 1/4 F	0.5	5	5.5	0.37	3.7	4	2000	196	7.7
ERP10LT	615 165 229 0	Hex. 1/4 F	1.5	10	12	1.1	7.4	8.8	1540	196	7.7
ERP20LT	615 165 230 0	Hex. 1/4 F	3.0	20	23	2.2	14.7	17	790	196	7.7



Angle head electric nutrunners

MODEL	PART NUMBER	OUTPUT DRIVE	TORQUE						ROTATIONAL SPEED	LENGTH	
			MIN.	RECOM MENDED	MAX.	MIN.	RECOM MENDED	MAX.		mm	in.
		in.	Nm	Nm	Nm	ft.lb	ft.lb	ft.lb	rpm		
ERAL1.5-15	615 165 356 0	Sq. 3/8	2	15	18	1.5	11	13.3	1511	408	16.1
ERAL1.5-25	615 165 357 0	Sq. 3/8	3	20	25	2.2	14.7	18.4	1511	408	16.1
ERAL2.30	615 165 362 0	Sq. 3/8	5	20	30	3.7	14.7	22	1511	433	17
ERAL2.40	615 165 363 0	Sq. 3/8	7	30	40	5.2	22	29.5	1169	433	17
ERAL2-60	615 165 364 0	Sq. 3/8	8	45	60	5.9	33	44	918	443	17.5
ERAL2-80	615 165 365 0	Sq. 3/8	10	65	80	7.4	48	59	750	455	17.9
ERAL2-80 SQ1/2	615 165 406 0	Sq. 1/2	10	65	80	7.4	48	59	750	455	17.9
ERAL4-90	615 165 384 0	Sq. 1/2	15	70	90	11	51.6	66	690	552	21.7
ERAL4-110	615 165 385 0	Sq. 1/2	20	90	110	14.7	66	81	540	552	21.7
ERAL4-120	615 165 386 0	Sq. 1/2	25	115	120	18.4	85	88.4	380	552	21.7
ERAL4-140	615 165 387 0	Sq. 1/2	30	125	140	22	92	103	360	554	21.8
ERAL4-170	615 165 388 0	Sq. 1/2	35	150	170	26	110.5	125	300	554	21.8
ERAL4-225	615 165 389 0	Sq. 3/4	60	200	225	44	147	166	220	604	23.8
ERAL6-135	615 165 390 0	Sq. 1/2	30	125	135	22	92	100	640	639	25.2
ERAL6-170	615 165 441 0	Sq. 1/2	30	150	170	22	110	125	520	639	25.2
ERAL6-280	615 165 391 0	Sq. 3/4	50	250	280	37	184	206	300	661	26
ERAL6-350	615 165 392 0	Sq. 3/4	75	300	350	55	221	258	250	702	27.6
ERAL6-480	615 165 393 0	Sq. 3/4	100	400	480	73	295	354	190	702	27.6



In-line electric nutrunners

MODEL	PART NUMBER	OUTPUT DRIVE	TORQUE						ROTATIONAL SPEED	LENGTH	
			MIN.	RECOM MENDED	MAX.	MIN.	RECOM MENDED	MAX.		mm	in.
		in.	Nm	Nm	Nm	ft.lb	ft.lb	ft.lb	rpm		
ERD5J	615 165 060 0	Hex. 1/4 F	0.5	6	8	0.37	4.4	5.9	2070	379	14.9
ERDL1.5-12	615 165 366 0	Hex. 1/4 F	2	10	12	1.5	7.4	8.8	1586	365	14.4
ERDL1.5-20	615 165 367 0	Hex. 1/4 F	3	15	20	2.2	11	14.7	1586	365	14.4
ERDL1.5-30	615 165 368 0	Sq. 3/8	5	20	30	3.7	14.7	22	1586	357	14
ERDL2-40	615 165 369 0	Sq. 3/8	7	30	40	5.2	22	29.5	1159	382	15
ERDL2-50	615 165 370 0	Sq. 3/8	8	40	50	5.9	29.5	36.9	898	382	15
ERDL4-60	615 165 407 0	Sq. 3/8	20	50	60	14.7	36.8	44.2	1030	475	18.7
ERDL4-80	615 165 394 0	Sq. 1/2	20	70	80	14.7	51.6	59	650	475	18.7
ERDL4-135	615 165 395 0	Sq. 1/2	30	120	135	22.1	88.4	99.6	400	502	19.8
ERDL6-170	615 165 396 0	Sq. 1/2	40	150	170	29.5	110.5	125.3	530	590	23.2
ERDL6-220	615 165 397 0	Sq. 3/4	50	200	220	36.8	147.4	162	380	597	23.5
ERDL6-250	615 165 398 0	Sq. 3/4	60	250	250	44.2	184	184	290	597	23.5



Accessories: see page 50



MultiCVIL II - Main Features

MULTICHANNEL SYSTEM

Drive up to 32 fixtured spindles

One CVIL Master +
x times CVIL Slave

Through CVIPC2000 (to Master only)

Cycles Phases management

- 31 different cycles
- Combines up to 20 phases in a fastening cycle

Data collection

- CVIPC2000
- CVINET WEB

Fieldbuses

- By additional modules
- By Ethernet ports
- Flexible mapping

Isagraf, embedded PLC software to manage:

- Assembly station
- HMI

FIXTURED SPINDLES

- From 1 to 1900Nm
- EME straight
- EMEOF with Offset for close center distance application
- EMEL "L" shape reduces the height of the tool

Torque transducer

- High accuracy
- A10 class
- Digital communication between the tool and controller
- Memory chip with all characteristics of the tool: transducer sensitivity, gear ratio, maintenance info, etc...

One of best TS (torque/speed) ratio on the market

Resolver based long life brushless motor

50 or 60mm telescopic stroke

ONE CABLE

- **Motor power**
- **Digital connection of the transducer and memory device**
- **Up to 45 meters**
- **Design to be used in robot applications**



Flexibility of tightening process

EASY PROGRAMMING OF THE TIGHTENING SEQUENCE WITH FULL SYNCHRONIZATION

Run Down phase

Spindle 1-2-3-4-5-6-7-8-9-10

Final Speed phase

Spindle 1-2

Final Speed phase

Spindle 3-4-5-6

Final Speed phase

Spindle 7-8-9-10

Automatic Repair Action

Reverse all spindles and retry once

Jump to phase 2

End of the cycle

Reporting



CVIPC

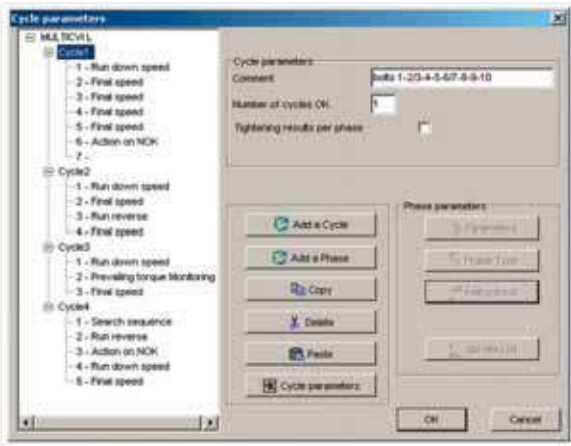

MAIN FUNCTIONS

MultiCVIL II

Number of channels 1 to 32

Number of cycles 31

Number of phases 20

Batch count 999

Bar code reading via RS232 port

Tightening results

Torque + Angle + Date

+ Time + Report up to 32 000

Number of curves (per channel) 10

Tightening strategies

Torque control + angle monitoring ✓

Angle control + torque monitoring ✓

T control + (Angle + torque rate) monitoring... ✓

Angle control + (Torque + torque rate) monitoring... ✓

Yield point strategy ✓

Stall torque ✓

Prevailing torque..... ✓

Current monitoring ✓

Reverse at Angle control ✓

Tightening connectivity

Input/Output..... 8/8

RS232 port OK

Ethernet RJ45..... 8 sockets

Fieldbuses Optional module

Embedded PLC software..... OK

IP54 Optional module

Emergency stop..... 2 channels

Multi display of tightening curves for joint analysis in real time

CVINET

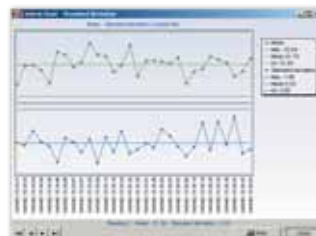
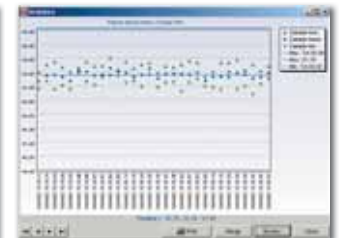
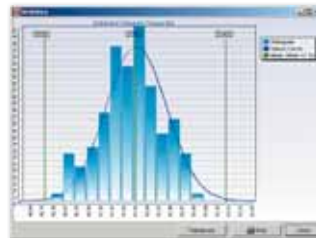
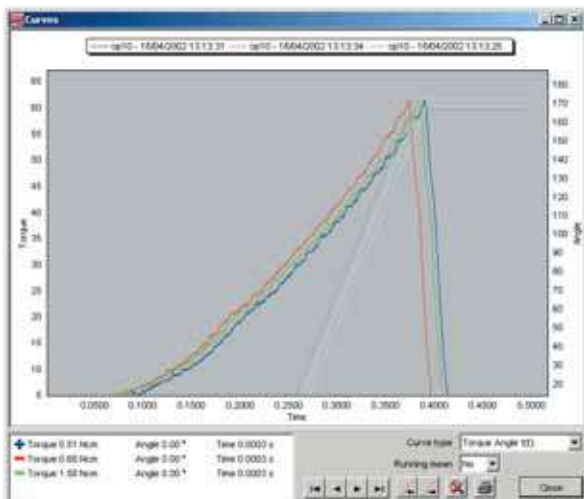

Controllers - MultiCVIL II



MODEL	PART NUMBER	CONSUMPTION (CURRENT)		MAINS SUPPLY	WIDTH		DIMENSIONS HEIGHT		DEPTH		WEIGHT	
		115V	230V		mm	in.	mm	in.	mm	in.	kg	lb.
CVIL II M (Master)	615 932 682 0	4A	2A	Single phase	130	5.1	278	10.9	291	11.5	5.9	13
CVIL II S (Slave)	615 932 683 0	4A	2A	Single phase	130	5.1	278	10.9	291	11.5	5.9	13
Multicombox	615 929 044 0											

OPTIONAL ACCESSORIES

	PART NO.
• IP54 option	615 932 684 0
Fieldbus module	
Ethernet IP Module	615 927 594 0
Profi bus DP Module	615 927 595 0
Profi net Module	615 927 596 0
Devicenet Module	615 927 599 0
MODBUS TCP Slave	615 927 615 0

Kit version

One CVIL-Master n.CVIL-Slaves Software CVIPC 2000 + Power cord Multicombox

Contact your Desoutter representative for assistance



Also available:
Specially designed a frame to secure controllers and ensure safe and tidy wiring

Turn Key Solution

One CVIL-Master n.CVIL-Slaves Software CVIPC 2000 + Network cables & Power cord One power box supply with E Stop - Ethernet switches Multicombox - Circuit breakers

Powerbox depending on power supply

Fixtured electric spindles

High durability of EME tools

- Long life gear boxes
- Brushless motor
- High output torque transducer for a larger torque range

MODEL	PART NUMBER	SQUARE DRIVE	TORQUE RANGE		ROTATIONAL SPEED	MIN. CENTRE DISTANCE		LENGTH	
			in.	Nm		ft.lb	rpm	mm	in.
EME35-10J	615 165 423 0	3/8	1-8	0.7-5.9	2067	43.2	1.7	283	11.1
EME35-20J	615 165 424 0	3/8	4-15	2.1-11	2067	43.2	1.7	308	12.1
EME38-10J	615 165 425 0	3/8	9-30	6.6-22	1287	43.2	1.7	355	14
EME38-20J	615 165 426 0	3/8	10-45	7.4-33	1092	43.2	1.7	355	14
EME51-10J	615 165 427 0	1/2	20-70	15-52	650	51.2	2.0	374	14.7
EME51-20J	615 165 428 0	1/2	30-135	22-99	403	51.2	2.0	401	15.8
EME60-10J	615 165 429 0	1/2	20-95	15-70	923	60.2	2.4	431	16.9
EME60-20J	615 165 430 0	3/4	50-175	37-129	507	60.2	2.4	431	16.9
EME60-30J	615 165 431 0	3/4	70-250	52-184	299	60.2	2.4	467	18.4
EME80-10J	615 165 432 0	3/4	80-300	59-221	286	80.2	3.2	494	19.5
EME80-20J	615 165 433 0	3/4	120-450	88-221	195	80.2	3.2	494	19.5
EME80-30J	615 165 434 0	1	180-650	133-479	130	80.2	3.2	494	19.5
EME80-40J	615 165 435 0	1	220-800	162-590	91	80.2	3.2	494	19.5
EME80-50J	615 165 436 0	1	220-1000	162-737	72	80.2	3.2	494	19.5
EME106-10J	615 165 437 0	1	430-1500	317-1105	52	106.2	4.2	564	22.2
EME106-20J	615 165 438 0	1	540-1900	398-1400	39	106.2	4.2	564	22.2



EMEL shape for close access

MODEL	PART NUMBER	SQUARE DRIVE	TORQUE RANGE		ROTATIONAL SPEED	MIN. CENTRE DISTANCE		LENGTH	
			in.	Nm		ft.lb	rpm	mm	in.
EMEL38-20J	615 165 517 0	3/8	10-45	7.4-33.2	1092	43.2	1.7	140.5	5.5
EMEL51-20J	615 165 518 0	1/2	30-135	22-99.5	403	51.2	2.0	166	6.5
EMEL60-20J	615 165 519 0	3/4	50-175	37-129	481	60.2	2.4	178	7
EMEL60-30J	615 165 520 0	3/4	70-250	52-184	312	60.2	2.4	178	7
EMEL80-40J	615 165 521 0	1	220-800	162-590	91	80.2	3.2	241	9.5



EME Offset with torque transducer in line with the output shaft

Increase access by using smallest CC distances offered

MODEL	PART NUMBER	SQUARE DRIVE	TORQUE RANGE		ROTATIONAL SPEED	MIN. CENTRE DISTANCE		LENGTH	
			in.	Nm		ft.lb	rpm	mm	in.
EME24-20 OF	615 165 512 0	3/8	4-20	2.9-15	1225	24	0.95	375.2	14.8
EME26-50 OF	615 165 513 0	3/8	7-50	5.2-40	985	26	1.02	387.5	15.2
EME30-80 OF	615 165 514 0	1/2	10-80	7.4-59	580	30	1.18	414.3	16.3
EME36-140 OF	615 165 515 0	1/2	19-140	14-103	375	36	1.42	454.4	17.7
EME40-180 OF	615 165 516 0	3/4	25-180	18-133	475	40	1.57	481.7	18.9
EME44-300 OF	615 165 602 0	3/4	80-300	59-221	217	45	1.77	632.5	24.9



Accessories: see page 51



Accessories

ERP / ERAL / ERDL

ACCESSORIES INCLUDED

ITEM	PART NO.	
	ERP	ERAL / ERDL
1 Side handle	467033	
2 Suspension bail	467003	
3 Horizontal bail ERAL - ERDL1.5 / 2		615 396 562 0
4 Reaction bar ring ERDL1.5 / 2		615 396 551 5
4 Reaction bar ERDL4		615 595 259 0
4 Reaction bar ERDL6		615 396 297 0
4 Reaction bar ERAL6- 350/-480		615 396 302 0

OPTIONAL ACCESSORIES

ITEM	PART NO.	
	ERP	ERAL / ERDL
5 Long lever start (included with ERD5J)		615 396 584 0
6 2nd lever start ERAL-ERDL1.5 / 2		615 396 553 0
7 High resistance side handle ERP	615 397 012 0	
7 Side reaction handle ERAL-ERDL1.5 / ERDL2		615 396 554 0
8 Suspension ring ERAL1.5-2		615 571 063 0
8 Suspension ring ERAL4		615 571 070 0
8 Suspension ring ERAL6		615 571 064 0
9 Reaction bar ring for angle heads		615 396 622 0
9 Reaction bar ring ERAL4-140/170 / ERAL6-135/170		615 396 227 0
9 Reaction bar ring ERAL4-225 / ERAL6-135 / 170		615 396 230 0
10 Rotary connector 90° ER		615 396 299 0
• Extension 200mm ERA(D)L1.5-2		615 396 865 0
• Extension 200mm ERA(D)L 4		615 396 866 0
11 Mounting plate with telescopic spindle ERDL1.5 / ERDL2		615 396 547 0
12 Plastic cover ERP.S	615 573 074 0	
12 Plastic cover ERP.L	615 573 075 0	
12 Plastic cover ERP.LT	615 573 076 0	
13 Plastic cover AH1 for ERAL1.5-15 / 25 / ERAL2-30 / 40		615 573 064 0
13 Plastic cover AH2 for ERAL2-60		615 573 065 0
13 Plastic cover AH3 for ERAL2-80		615 573 066 0
14 Plastic cover AH4 for ERAL4-90 / 110 / 120		615 573 069 0
14 Plastic cover AH5 for ERAL4-140 / 170 / ERAL6-135		615 573 070 0
14 Plastic cover AH6 for ERAL4-225		615 573 071 0
15 Plastic cover for ERDL1.5 / 2		615 573 067 0

Dessouter Tool Holster

16 DTH TWIN (single) without rail	615 811 411 0
17 DTH TWIN rail kit with 2 Twin holders	615 811 412 5
18 DTH TWIN stand kit with base & 2 Twin holders	615 811 413 5



Cable for ERP / ERAL / ERDL

Cable length:	2.5m (8.2ft)	5m (16ft)	10m (32.8ft)	15m (49.2ft)	20m (65.6ft)	25m (82ft)	30m (98ft)
• Nutrunners cable		615 917 492 0	615 917 494 0	615 917 495 0			
• Heavy duty nutrunner cable	615 917 570 0	615 917 571 0	615 917 572 0				
• Heavy duty extension cable		615 917 083 0	615 917 084 0	615 917 085 0	615 917 086 0	615 917 087 0	615 917 088 0

Socket Tray

• Socket tray (sockets not included)				615 936 005 0
Cable length:	1m (3.3ft)	5m (16ft)	10m (32.8ft)	15m (49.2ft)
• Cable for sockets tray	615 917 241 0	615 917 242 0	615 917 244 0	615 917 245 0

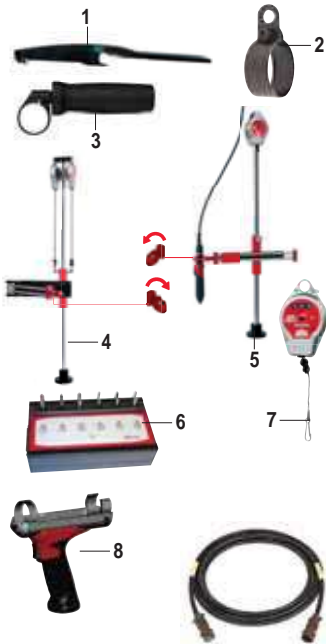

ERS / ERSA / ERSF

OPTIONAL ACCESSORIES

ITEM	PART NO.
1 Long lever Kit	615 321 254 0
2 Suspension yoke kit	615 791 080 0
3 Reaction handle	615 397 016 0
4 D53-25 Linear arm (tool clamp included) - (see pages 136-141)	615 810 702 0
4 D53-25X Linear arm, extended reach (tool clamp included) - (see pages 136-141)	615 810 703 0
5 D53-25S Folder arm (tool clamp included) - (see pages 136-141)	615 810 708 0
6 Bit Tray	615 929 025 0
7 Spring suspension balancer	50522
8 Pistol grip kit for ERS	615 390 059 0

Extension cable for ERS tools

Cable length:	5m (16.4ft)	10m (32.8ft)
• Extension cable	615 917 222 0	615 917 224 0

EME / EMEL

OPTIONAL ACCESSORIES

Transducer-holder for EME tool	PART NO.
• 3/8" square drive EME35/EME38	615 396 426 0
• 1/2" square drive EME51/EME60.10	615 396 427 0
• 3/4" square drive EME60.20/EME60.30	615 396 428 0
• 3/4" square drive EME80.10/EME80.20	615 396 429 0
• 1" square drive EME80.30/40/50 / EME106	615 396 430 0



EME adaptation on existing application (separated cable torque + motor cable)

	PART NO.
• EME adaptation on old cable	615 917 539 0

Cable for EME tools - MultiCVIL II & CVIL II

Cable length:	5m (16.4ft)	10m (32.8ft)	15m (49.2ft)	20m (65.6ft)	25m (82ft)	30m (98.4ft)
• Tool cable	615 917 541 0	615 917 542 0	615 917 543 0			
• Extension cable	615 917 083 0	615 917 084 0	615 917 085 0	615 917 086 0	615 917 087 0	615 917 088 0



Protocol, Software

MODEL	PART NUMBER
Reporting to TOOLSNET OPEN PROTOCOL 5 licences	615 927 577 0
Reporting to TOOLSNET OPEN PROTOCOL 10 licences	615 927 578 0
Reporting to TOOLSNET OPEN PROTOCOL 25 licences	615 927 579 0
Reporting to TOOLSNET OPEN PROTOCOL 50 licences	615 927 580 0

MODEL	PART NUMBER
OPEN PROTOCOL 5 licences	615 927 581 0
OPEN PROTOCOL 10 licences	615 927 582 0
OPEN PROTOCOL 25 licences	615 927 583 0
OPEN PROTOCOL 50 licences	615 927 584 0

MODEL	PART NUMBER
CVI PC2000 standard 1 install	615 927 522 0
CVI PC2000 standard 5 install	615 927 526 0
CVI PC2000 standard 25 install	615 927 537 0

MODEL	PART NUMBER
CVI PC2000 advanced 1 install	615 927 523 0
CVI PC2000 advanced 5 install	615 927 535 0
CVI PC2000 advanced 25 install	615 927 538 0





CVIC Range

Current controlled

Easy to integrate

Small size and smooth design for a simple installation

Speed up the set up time by using the self learning process
Provides automatic set up for the tool to optimize your fastening process

Multi torque capability

Replace multiple pneumatic tools with one electric tool per station



Fastening quality guaranteed in all your products

Set up a batch count to ensure all bots are tightened with correct strategy

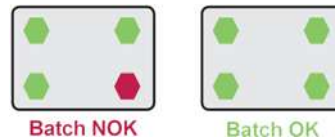

Quality of tightening

Control torque and angle with multi phases strategies

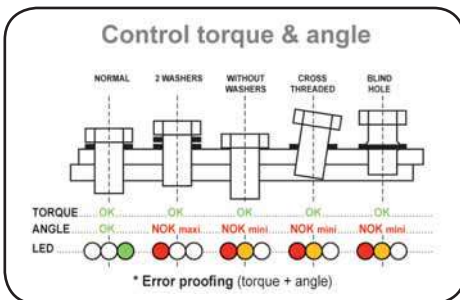

Advanced ergonomics

Maximize your operators' comfort with ergo stop and direct reporting led in the controller and on the tool



Open to peripherals

Increase your assembly quality and process through barcode reader, socket tray or bit tray
Control tightening order with our positioning system



Technical features

CVIC Range

MAIN FUNCTIONS	NORMAL		ECP HIGH TORQUE	
	L STANDARD	H ADVANCED	L STANDARD	H ADVANCED
Quick cycle with self-learning of the joint	✓	✓		
Number of cycles in the controller	1	15	1	15
Number of phases	15	15	15	15
Batch count (999 OK reports)	✓	✓	✓	✓

TIGHTENING RESULTS	5000 to 20000 according configuration			
Torque + Angle + Date + Time + Report				

TYPES OF PHASES IN A CYCLE				
Search Sequence	✓	✓		
Run Down speed	✓	✓	✓	✓
Final speed	✓	✓	✓	✓
Run reverse	✓	✓		
Action or NOK	✓	✓		
Prevailing torque monitoring	✓	✓		

FINAL SPEED STRATEGIES				
Torque control + Angle monitoring	✓	✓	✓	✓
Angle control + Torque monitoring	✓	✓	✓	✓

DISPLAY AND PROGRAMMING				
Display				
LCD display	✓	✓	✓	✓
Keyboard				
8 button keypad	✓	✓	✓	✓
Reports				
LEDs	6	6	6	6
PC Software Windows				
CVIPC2000 *: program cycles, collect, display and save results, run statistics, curves				
Connection 'point to point' (RS232)	✓	✓	✓	✓
Connection through ethernet	✓	✓	✓	✓

**All CVIPC2000 versions are compatible with CVICs*

MAINTENANCE				
Access to all tool parameters (tool memory)	✓	✓	✓	✓
Autotest of the complete system	✓	✓	✓	✓
Spindle rotation test	✓	✓	✓	✓
Input/Output selection	✓	✓	✓	✓
Date of the last maintenance operation	✓	✓	✓	✓
Total and partial cycle counters	✓	✓	✓	✓

PERIPHERALS				
Input/Output	8/8	8/8	8/8	8/8
Serial port RS232 (PC transfer, Bar code, Report output)	✓	✓	✓	✓
Ethernet connection (CVIPC2000 / CVInet)	✓	✓	✓	✓

MODEL				
CONTROLLER for low torque tools	CVIC II L-2	CVIC II H-2		
CONTROLLER for the other tools	CVIC II L-4	CVIC II H-4	CVIC II L-4	CVIC II H-4

MAINS SUPPLY				
Single-phase, automatic switching 110V/230V	✓	✓	✓	✓

Controllers - CVIC

Electric current control



CVIC II-L2
CVIC II-H2



CVIC II-L4
CVIC II-H4



MODEL	PART NUMBER	TOOLS	CONSUMPTION (current)		MAINS SUPPLY	WIDTH		DIMENSIONS HEIGHT		DEPTH		WEIGHT	
			115V	230V		mm	in.	mm	in.	mm	in.	kg	lb.

CVIC II CONTROLLERS

CVIC II-L2	615 932 676 0	ECS / ECPL(T) / ECD5 / MC35-10 / ECA15	4A	2A	Single-phase	130	5.1	278	10.9	291	11.5	5	11
CVIC II-H2	615 932 677 0	ECS / ECPL(T) / ECD5 / MC35-10 / ECA15	4A	2A	100 to 250 V	130	5.1	278	10.9	291	11.5	5	11
CVIC II-L4	615 932 678 0	Other tools	8A	4A	Single-phase	130	5.1	278	10.9	291	11.5	5	11
CVIC II-H4	615 932 679 0	Other tools	8A	4A	100 to 250 V	130	5.1	278	10.9	291	11.5	5	11

START-UP KIT to be ordered with the controller
Including: **Power cable and plug**

PLUG	DESCRIPTION	PART NO.
A	European	615 917 201 0
B	US	615 917 203 0
C	UK	615 917 202 0
D	Chinese	615 917 206 0

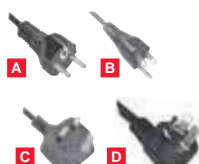

OPTIONAL ACCESSORIES

	PART NO.
• PC cable Length 2m (78.7")	615 917 047 0
• Printer cable Length 2m (78.7")	615 917 011 0
• CVIPC2000 for CVIS/CVIC 1 Installation	615 927 521 0
• CVIPC2000 for CVIS/CVIC 5 Installations	615 927 534 0
• CVI-net 1 controller	615 927 555 0

Torque Range

Performances of Portable electric nutrunners ECS, ECSA and ECP Series

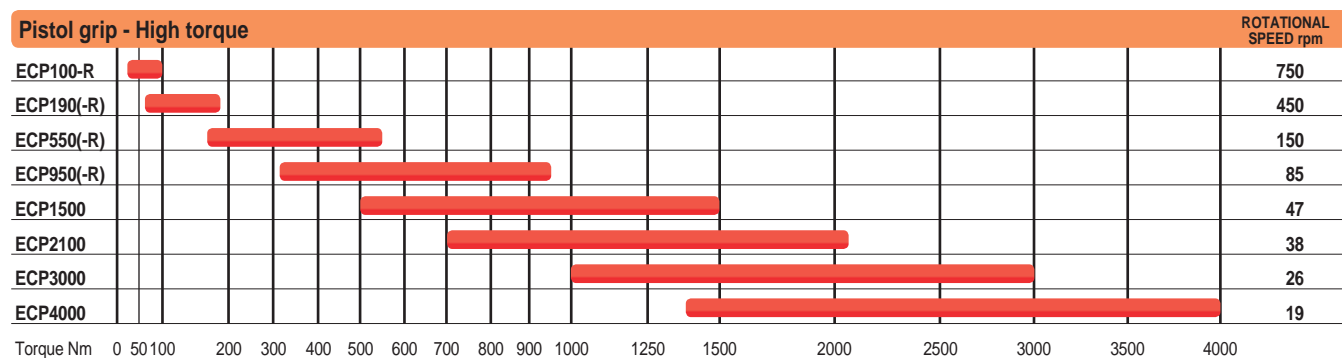
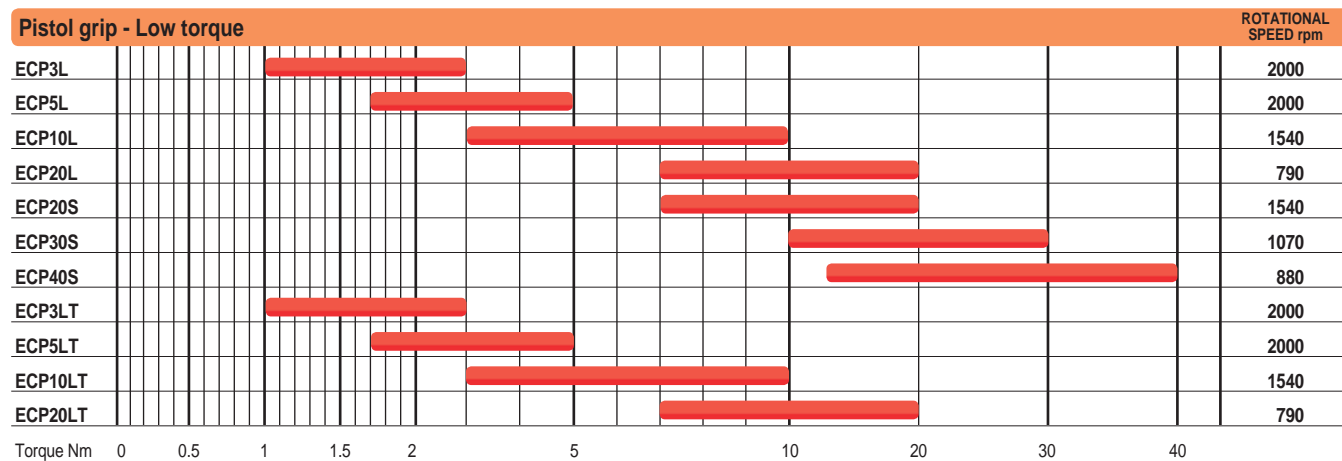
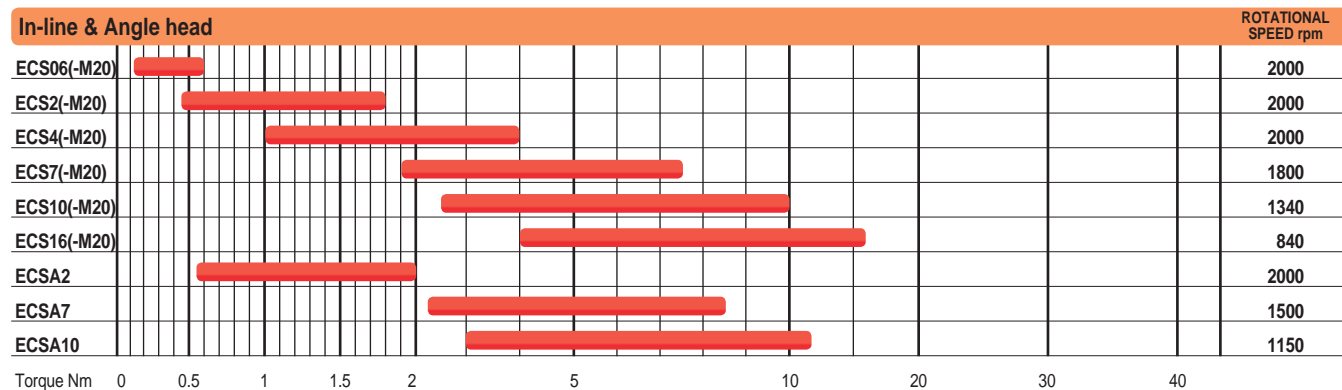

Torque Range

Performances of Portable electric nutrunners ECA and ECD Series

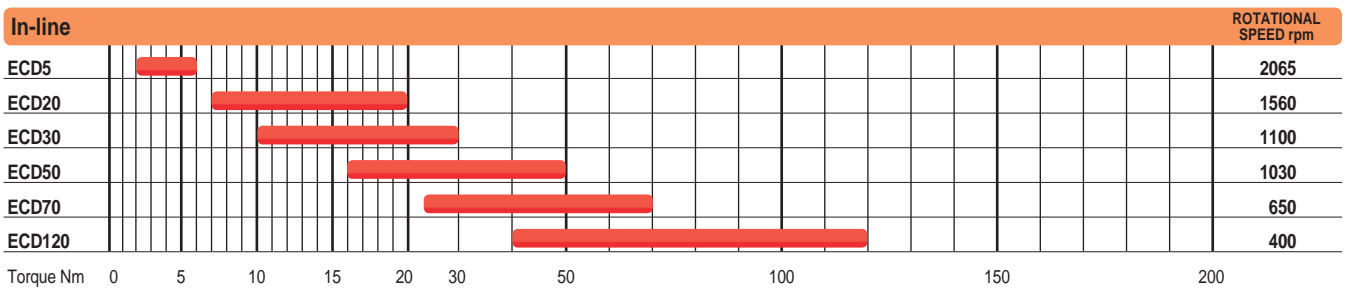
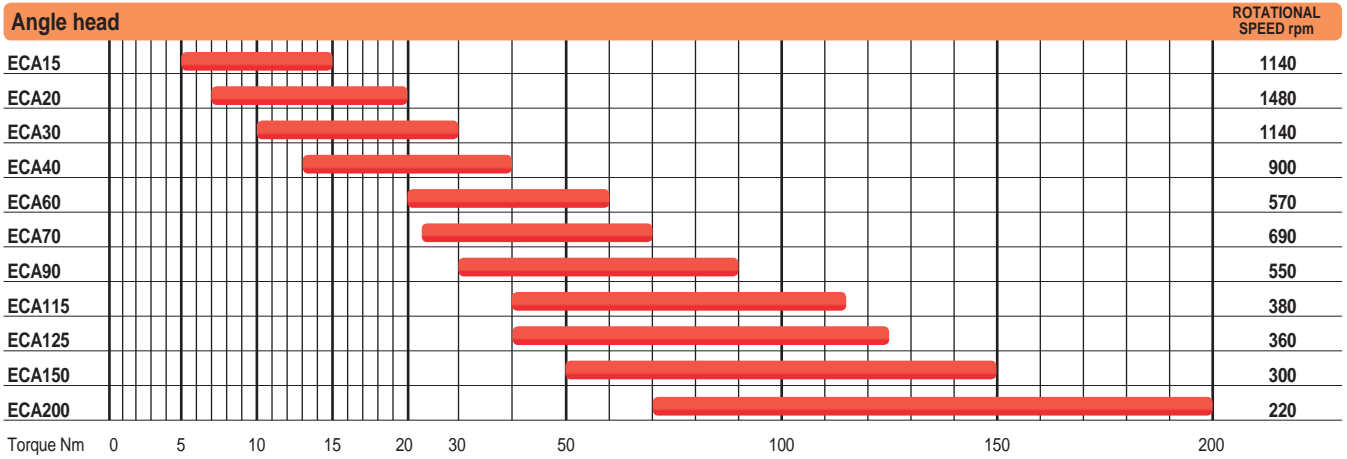

Performances of Fixtured electric spindles ECSF and MC Series

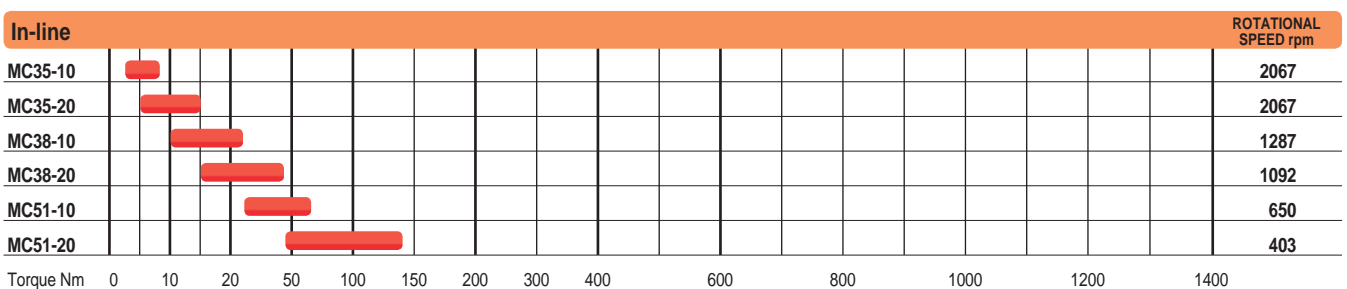
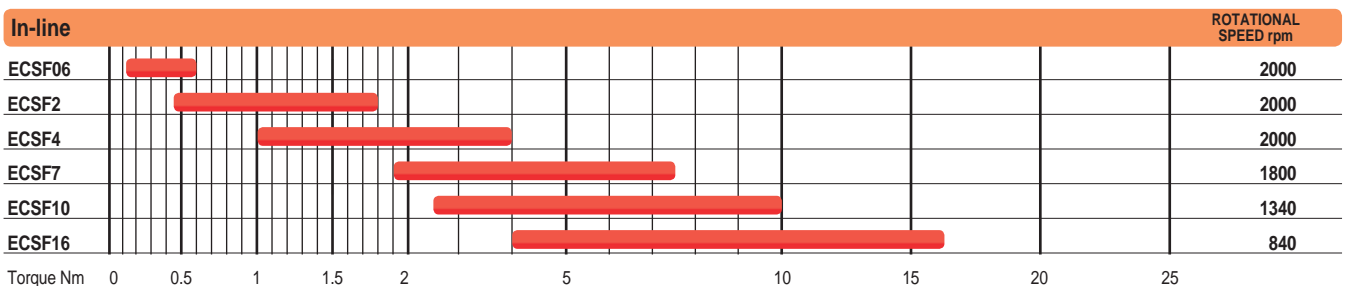

Electric Screwdrivers - CVIC

0.12 to 16 Nm (1.1 to 141.6 in.lb) - 840 to 2000 rpm

The ECS series offers outstanding torque accuracy and operator ergonomics, making it the ideal choice for assembly operations that require a high level of quality



Improve your joint visibility



A



B



Adapt your tool with accessories



C



OK



NOK



BATCH OK

Get the best tightening feedback directly on the tool

Accessories: see pages 68-69

PIC REF	MODEL	PART NUMBER	OUTPUT HEX	TORQUE RANGE				ROTATIONAL SPEED	LENGTH		WEIGHT	
				MIN.	MAX	MIN	MAX.		mm	in.	kg	lb.
			in.	Nm	Nm	in.lb	in.lb	rpm				
ELECTRIC SCREWDRIVERS - IN-LINE												
A	ECS06	615 165 442 0	Hex. 1/4 F	0.12	0.6	1.1	5.3	2000	285	11.2	0.6	1.3
A	ECS2	615 165 443 0	Hex. 1/4 F	0.45	1.8	4	15.9	2000	285	11.2	0.6	1.3
A	ECS4	615 165 445 0	Hex. 1/4 F	1	4	8.8	35.4	2000	285	11.2	0.6	1.3
A	ECS7	615 165 446 0	Hex. 1/4 F	1.9	7.5	16.8	66.4	1800	285	11.2	0.7	1.5
A	ECS10	615 165 444 0	Hex. 1/4 F	2.5	10	22.1	88.5	1340	285	11.2	0.7	1.5
A	ECS16	615 165 459 0	Hex. 1/4 F	4	16	35.4	141.6	840	285	11.2	0.7	1.5
ELECTRIC SCREWDRIVERS - IN-LINE												
B	ECS06-M20	615 165 454 0	Hex. 1/4 F	0.12	0.6	1.1	5.3	2000	285	11.2	0.6	1.3
B	ECS2-M20	615 165 455 0	Hex. 1/4 F	0.45	1.8	4	15.9	2000	285	11.2	0.6	1.3
B	ECS4-M20	615 165 456 0	Hex. 1/4 F	1	4	8.8	35.4	2000	285	11.2	0.6	1.3
B	ECS7-M20	615 165 457 0	Hex. 1/4 F	1.9	7.5	16.8	66.4	1800	285	11.2	0.7	1.5
B	ECS10-M20	615 165 458 0	Hex. 1/4 F	2.5	10	22.1	88.5	1340	285	11.2	0.7	1.5
B	ECS16-M20	615 165 460 0	Hex. 1/4 F	4	16	35.4	141.6	840	285	11.2	0.7	1.5
ELECTRIC SCREWDRIVERS - ANGLE HEAD												
C	ECSA2	615 165 447 0	Hex. 1/4 F	0.55	2.2	4.9	19.5	2000	329	12.9	0.6	1.3
C	ECSA7	615 165 448 0	Hex. 1/4 F	2.2	8.5	19.5	75.2	1500	329	12.9	0.7	1.5
C	ECSA10	615 165 449 0	Hex. 1/4 F	3	11.5	26.6	101.8	1150	329	12.9	0.7	1.5

Pistol grip electric nutrunners - CVIC

1 to 40 Nm (0.7 to 29.1 ft.lb) - 790 to 2000 rpm



A



B



C



D

Accessories: see pages 68-69 

PIC REF	MODEL	PART NUMBER	OUTPUT DRIVE	TORQUE RANGE		ROTATIONAL SPEED AT		LENGTH		WEIGHT	
				in.	Nm	ft.lb	rpm/230 V	rpm/110 V	mm	in.	kg
A	ECP3L	615 165 199 0	Hex. 1/4F	1.0-3.0	0.7-2.2	2000	2000	196	7.7	1.0	2.2
A	ECP5L	615 165 200 0	Hex. 1/4F	1.7-5.0	1.3-3.7	2000	2000	196	7.7	1.0	2.2
A	ECP10L	615 165 201 0	Hex. 1/4F	3.0-10	2.2-7.4	1540	1540	196	7.7	1.1	2.4
A	ECP20L	615 165 202 0	Hex. 1/4F	7.0-20	5.2-15	790	790	196	7.7	1.1	2.4
B	ECP20S	615 165 203 0	Hex. 1/4F	7.0-20	5.2-15	1540	1540	221	8.7	1.2	2.6
B	ECP30S	615 165 204 0	Sq. 3/8	10-30	7.4-22	1070	1070	217	8.5	1.2	2.6
C	ECP40S	615 165 262 0	Sq. 3/8	13-40	9.6-29	880	880	263	10.4	2.1	4.5
D	ECP3LT	615 165 231 0	Hex. 1/4F	1.0-3	0.7-2.2	2000	2000	196	7.7	1.0	2.2
D	ECP5LT	615 165 232 0	Hex. 1/4F	1.7-5	1.3-3.7	2000	2000	196	7.7	1.0	2.2
D	ECP10LT	615 165 233 0	Hex. 1/4F	3.0-10	2.2-7.4	1540	1540	196	7.7	1.1	2.4
D	ECP20LT	615 165 234 0	Hex. 1/4F	7.0-20	5.2-15	790	790	196	7.7	1.1	2.4

Electric High Torque Pistol Grip - CVIC

30 to 4000 Nm (22 to 2950 ft.lb) - 19 to 750 rpm

For your quality-critical applications
 Impact and impulse tools have been a production favourite for many years
 This innovative electric pistol tool allows you to have total quality control without sacrificing productivity

Offering all benefits of Electric Brushless Tools
 Maintenance free motor
 Less than 70 dB(A)
 Environment friendly (no air, no oil)
 Repeatability and no need to re-torque
 One Tool = up to 15 different torque settings



PIC REF	MODEL	PART NUMBER	SQUARE DRIVE	TORQUE RANGE				ROTATIONAL SPEED	LENGTH		WEIGHT	
				MIN.	MAX.	MIN.	MAX.		mm	in.	kg	lb.
			in.	Nm	Nm	ft.lb	ft.lb	rpm				
NON REVERSIBLE												
A	ECP190	615 165 399 0	1/2	60	190	44	140	450	314	12.4	3.0	6.6
A	ECP550	615 165 400 0	3/4	175	550	129	405	150	351	13.8	3.7	8.1
A	ECP950	615 165 401 0	1	310	950	228	700	85	379	14.9	4.0	8.8
B	ECP1500	615 165 524 0	1	500	1500	368	1105	47	413	16.3	6.9	15.2
C	ECP2100	615 165 525 0	1-1/2	700	2100	516	1548	38	485	19.1	14.2	31.3
C	ECP3000	615 165 526 0	1-1/2	1000	3000	737	2212	26	485	19.1	14.2	31.3
C	ECP4000	615 165 527 0	1-1/2	1330	4000	980	2950	19	485	19.1	14.2	31.3
REVERSIBLE												
D	ECP100-R	615 165 523 0	1/2	30	100	22	73	750	328	12.9	3.4	7.5
D	ECP190-R	615 165 451 0	1/2	60	190	44	140	450	328	12.9	3.4	7.5
D	ECP550-R	615 165 452 0	3/4	175	550	129	405	150	365	14.4	4.3	9.5
D	ECP950-R	615 165 453 0	1	310	950	228	700	85	395	15.6	4.6	10.2

Electric High Torque Pistol Grip - CVIC

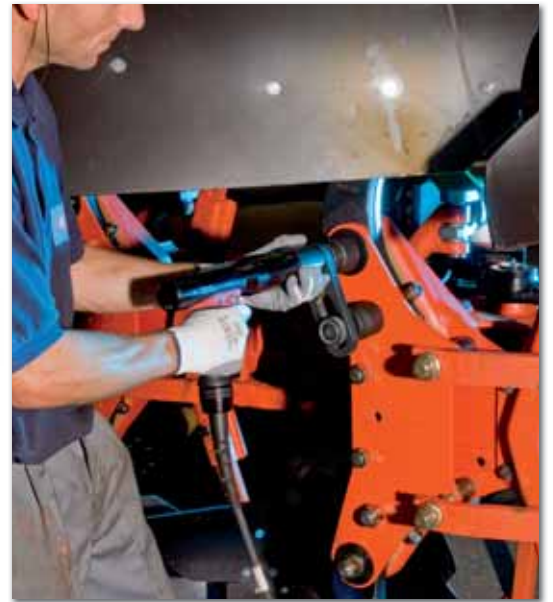

OPTIONAL ACCESSORIES

	1 STRAIGHT REACTION BAR	2 BLANK REACTION BAR	3 S TYPE REACTION BAR	4 SLIDING DRIVE REACTION BAR	5 SUSPENSION BAIL	6 PROTECTION SLEEVE
ECP100-R / ECP190 / ECP190-R	615 596 009 5	615 596 010 0	615 596 011 0	N/A	615 571 072 0	615 573 206 0
ECP550 / ECP550-R	615 596 012 5	615 596 013 0	615 596 015 0	615 596 014 0	615 571 072 0	615 573 206 0
ECP950 / ECP950-R	615 596 016 5	615 596 017 0	615 596 019 0	615 596 018 0	615 571 072 0	615 573 206 0
ECP1500	615 596 109 5	615 596 110 0	615 596 112 0	615 596 111 0	615 571 072 0	615 573 206 0
ECP2100 / ECP3000 / ECP4000	N/A	INCLUDED	N/A	N/A	N/A	615 573 206 0



Angle head electric nutrunners - CVIC

5 to 200 Nm (3.7 to 147 ft.lb) - 200 to 1480 rpm



MODEL	H		Ø1		Ø2	
	mm	in.	mm	in.	mm	in.
ECA15	45.5	1.8	28	1.10	27	1.06
ECA20 - ECA30	45.5	1.8	28	1.10	27	1.06
ECA40	51.5	2.0	35	1.40	27	1.06
ECA60	57.5	2.3	40	1.60	30.5	1.20
ECA70- ECA90- ECA115	66.0	2.6	45	1.77	37	1.46
ECA125 - ECA150	69.0	2.7	50	1.97	42	1.65
ECA200	86.0	3.4	60	2.36	42	1.65

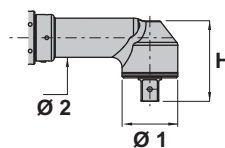

Accessories: see pages 68-69

PIC REF	MODEL	PART NUMBER	SQUARE DRIVE	TORQUE RANGE		ROTATIONAL SPEED AT		LENGTH		WEIGHT	
				in.	Nm	ft.lb	rpm/230 V	rpm/110 V	mm	in.	kg
A	ECA15	615 165 192 0	3/8	5-15	3.7-11	1140	1140	406	16.0	1.3	2.9
A	ECA20	615 165 100 0	3/8	7-20	5.2-15	1480	1480	431	16.9	1.7	3.7
A	ECA30	615 165 101 0	3/8	10-30	7.4-22	1140	1140	431	16.9	1.7	3.7
B	ECA40	615 165 102 0	3/8	13-40	9.6-29	900	900	441	17.4	1.8	4.0
B	ECA60	615 165 103 0	3/8	20-60	14.7-44	570	570	453	17.8	1.9	4.2
C	ECA70	615 165 104 0	1/2	23-70	16.9-52	690	690	538	21.2	3.3	7.3
C	ECA90	615 165 105 0	1/2	30-90	22.1-66	550	550	538	21.2	3.3	7.3
C	ECA115	615 165 106 0	1/2	39-115	28.7-85	380	380	538	21.2	3.3	7.3
C	ECA125	615 165 188 0	1/2	40-125	29.5-92	360	360	541	21.3	3.6	7.9
C	ECA150	615 165 189 0	1/2	50-150	36.8-111	300	300	541	21.3	3.6	7.9
D	ECA200	615 165 190 0	3/4	70-200	51.6-147	200	200	591	23.3	3.8	8.4

In-line electric Nutrunners - CVIC

2 to 120 Nm (1.5 to 88 ft.lb) - 400 to 2065 rpm



A



B



C

Accessories: see pages 68-69 

PIC REF	MODEL	PART NUMBER	OUTPUT DRIVE	TORQUE RANGE		ROTATIONAL SPEED AT		LENGTH		WEIGHT	
				in.	Nm	ft.lb	rpm/230 V	rpm/110 V	mm	in.	kg
A	ECD5	615 165 068 0	Hex 1/4	2-6	1.5-4.4	2065	2065	346	13.6	1.0	2.4
B	ECD20	615 165 093 0	Hex 1/4	7-20	5.2-15	1560	1560	388	15.3	1.5	3.3
B	ECD30	615 165 094 0	Sq 3/8	10-30	7.4-22	1100	1100	380	15.0	1.5	3.3
C	ECD50	615 165 095 0	Sq 3/8	16-50	11.8-37	1030	1030	456	17.9	2.6	5.7
C	ECD70	615 165 096 0	Sq 1/2	23-70	16.9-52	650	650	461	18.1	2.6	5.7
C	ECD120	615 165 097 0	Sq 1/2	40-120	29.5-88	400	400	488	19.2	3.1	6.8

Fixtured electric spindles - CVIC

0.12 to 16 Nm (1.1 to 141.6 in.lb) - 840 to 2000 rpm



A



Offset head for application with close centers
(minimum 19mm)



Automatically adjust the stroke for multispindle
applications with spring loaded shafts



Mount your spindle easily on a support
using the adapted flange

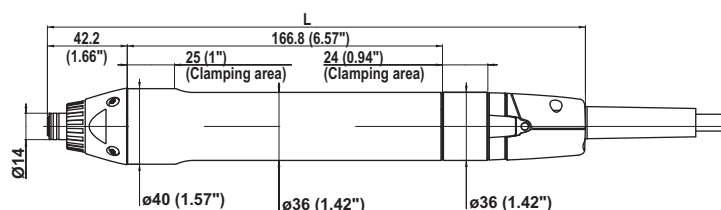

Accessories: see page 68

PIC REF	MODEL	PART NUMBER	OUTPUT HEX	TORQUE RANGE		ROTATIONAL SPEED	LENGTH L		WEIGHT	
				Nm	in.lb		mm	in.	kg	lb.
A	ECSF06	615 165 501 0	Hex. 1/4 F	0.12-0.6	1.1-5.3	2000	285	11.2	0.6	1.3
A	ECSF2	615 165 502 0	Hex. 1/4 F	0.45-1.8	4.0-15.9	2000	285	11.2	0.6	1.3
A	ECSF4	615 165 503 0	Hex. 1/4 F	1.0-4.0	8.8-35.4	2000	285	11.2	0.6	1.3
A	ECSF7	615 165 504 0	Hex. 1/4 F	1.9-7.5	16.8-66.4	1800	285	11.2	0.7	1.5
A	ECSF10	615 165 505 0	Hex. 1/4 F	2.5-10	22.1-88.5	1340	285	11.2	0.7	1.5
A	ECSF16	615 165 506 0	Hex. 1/4 F	4.0-16	35.4-141.6	840	285	11.2	0.7	1.5

Fixtured electric spindles - CVIC

2.5 to 135 Nm (1.8 to 99 ft.lb) - 403 to 2067 rpm



A



B

Accessories: see page 69 

For MC.tools with Offset heads, please contact your local Desoutter sales engineer for more information

PIC REF	MODEL	PART NUMBER	SQUARE DRIVE	TORQUE RANGE		ROTATIONAL SPEED AT		TELESCOPIC		MIN CENTRE DISTANCE		LENGTH		WEIGHT	
			in.	Nm	ft.lb	rpm/230 V	rpm/110 V	mm	in.	mm	in.	mm	in.	kg	lb.
A	MC35-10	615 165 107 0	3/8	2.5-8	1.8-5.9	2067	2067	50	1.97	43.2	1.7	276	10.9	1.7	3.7
A	MC35-20	615 165 108 0	3/8	5-15	3.7-11	2067	2067	50	1.97	43.2	1.7	301	11.8	2.0	4.4
A	MC38-10	615 165 109 0	3/8	10-30	7.4-22	1287	1287	50	1.97	43.2	1.7	347	13.7	2.0	4.4
A	MC38-20	615 165 110 0	3/8	15-45	11-33	1092	1092	50	1.97	43.2	1.7	347	13.7	2.0	4.4
B	MC51-10	615 165 111 0	1/2	25-70	18-52	650	650	50	1.97	51.2	2.0	366	14.4	2.9	6.4
B	MC51-20	615 165 112 0	1/2	45-135	33-99	403	403	50	1.97	51.2	2.0	393	15.4	3.5	7.7

Posco 500 Positioning system

Posco 500 – Error proofing solution with positioning system

Cost effective error proofing

Comprised of a control unit and encoder equipped tool stand, the Posco 500 system ensures that operators perform tightening operations in the right sequence at the right torque, with the right tool in the right position

Increased operator versatility

Because it guides the operator step by step, it reduces the amount of training each operator requires and allows operators to move between operations without impacting the level of quality

Flexibility and control

Used in conjunction with an encoder equipped tool stand, the system ensures that the tool is positioned properly during the operation. The ability to use digital input and output signals will confirm to your PLC that the job is done

Easy programming

The Posco 500 system lets you program a sequence of operations by "self learning mode" and ensures that the steps are completed in the right order and in the right conditions



Tool stand with X/Y

Digital absolute encoder

Analogical absolute encoder

Optional bittray



Controller for electric tools

LINEAR ARM	PART NO.
D53-5 X/Y-axle	615 397 874 0
D53-12 X/Y-axle	615 397 875 0
D53-25 X/Y-axle	615 397 876 0
D53-50 X/Y-axle	615 397 877 0
D53-100 X/Y-axle	615 397 878 0
SWIVEL ARM	PART NO.
D53-5 S X/Y-axle	615 397 879 0
D53-12 S X/Y-axle	615 397 880 0
D53-25 S X/Y-axle	615 397 881 0
D53-50 S X/Y-axle	615 397 882 0
D53-100 S X/Y-axle	615 397 883 0

More on Stand D53 (S) X/Y See "Accessories Catalog"

CABLE	PART NO.
Cable Posco 500 / I-O CVI	615 917 534 0
Cable Posco 500 / Bit-Tray	615 917 533 0
Cable Bit-Tray / I-O CVI	615 917 535 0
Cable Y RS232	615 917 536 0
I/O Adaptor for CVIx II controllers	615 919 003 0
SOFTWARES & LICENCES	PART NO.
Barcode license	615 927 571 0
Advanced Programming Licence	615 927 572 0
PC Connection licence 1 User	615 927 573 0
PC Connection licence 5 Users	615 927 574 0
PC Connection licence 10 Users	615 927 575 0
FAS support licence	615 936 048 0
POSCO 500 BOX	PART NO.
Posco 500 controller desk	615 932 656 0
Posco 500 controller desk with I/O ext	615 932 658 0
Posco500 controller wall with I/O ext	615 932 659 0
AC/DC adapter 90-260V/24V 30W	615 936 047 0
I/O add-on board	615 929 026 0
OTHERS	PART NO.
Bit tray module	615 929 025 0
Mounted set	615 930 777 0

Positioning system - POSCO

The POSCO Vision implements position monitoring and safety operation through operator guidance by a TFT color display
The entire assembly process can be programmed, controlled and monitored

Visualization

Display of the process and the parts



POSCO VISION Control Panel

High Flexibility

Every project is independent

Selection of operation

- Intelligent rotary knob
- Integrated button
- External Keyboard

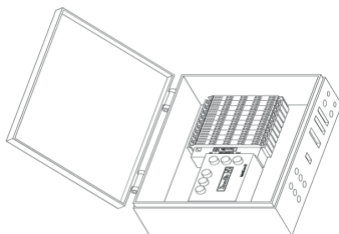

Posco Vision MultiCon

Up to 3 tool stand
2 RS-232 port
Network connection



I/O Expander

Up to 64 inputs and outputs

POSCO VISION	PART NO.
Posco Vision Control panel	615 932 710 0
Posco Vision MultiCon	615 932 711 0
Posco Vision I/O Expander	615 932 712 0
Posco Vision Can Cable 3m (9.8 ft)	615 917 506 0
Posco Vision cable Com 4m (13.1 ft)	615 917 507 0

COMPLETE BOX	PART NO.
Posco Vision complet Box 16 I/O	615 932 713 0
Posco Vision complet Box 64 I/O	615 932 714 0

LICENCE SOFTWARE	PAR NO.
Posco Vision encodeurs Port2	615 927 621 0
Posco Vision encodeurs Port3	615 927 622 0
Posco Vision RS3232 Port3	615 927 623 0
Posco Vision RS3232 Port4	615 927 624 0
Posco Vision Visualisation	615 927 625 0
Posco Vision MES (BDE)	615 927 626 0
Posco Vision PC Software	615 927 628 0
Posco Vision Barcode	615 927 629 0

Accessories

ECS / ECP / ECA / ECD



ACCESSORIES INCLUDED

ITEM	PART NO.
1 Side handle for ECP.L/S/LT versions	467033
2 Fixed suspension bail for ECP.LT	467003
2 Fixed suspension bail for ECS	205 049 537 3
3 Stationary suspension bail for ECA15/20/30/40/60 / ECD	615 571 056 0
3 Stationary suspension bail for ECA90/115/125/150/200	615 571 050 0
• Socket ball retainer 3/8" for ECA15/20/30/40/60	615 770 028 0
4 Reaction bar for ECD20/30	615 396 191 0
4 Reaction bar for ECD50/70/120	615 595 259 0



OPTIONAL ACCESSORIES

ITEM	PART NO.
6 Reaction handle for ECS	615 397 016 0
7 High resistance Side handle for ECP L/S/LT versions	615 397 012 0
8 Rotary right angle tool connector for EC	615 396 300 0
9 Stationary suspension bail for ECSA	615 571 080 0
• Suspension bail on a swivel for ECP L/S	615 396 121 0
9 Suspension bail on a swivel for ECP HT	615 571 072 0
10 Suspension bail on a swivel for ECA20/30/40/60 / ECD5/20/30	615 396 228 0
10 Suspension bail on a swivel for ECA70/90/115/125/150/200 / ECD5	615 396 229 0
• Top cable length 4m for ECP.LT	615 917 420 0
• Reaction bar ring for ECD20/30	615 396 191 0
11 Reaction bar ring for ECA60	615 396 226 0
11 Reaction bar ring for ECA70/90/115/125/150	615 396 227 0
• Reaction bar ring for ECA200	615 396 230 0
12 Long lever start for ECA / ECD	615 396 584 0
• Tool clamp for ECD5	615 396 616 0
• Tool clamp for ECS	615 396 616 0
13 Protection sleeve for ECP HT	615 573 206 0
14 Pistol grip kit for ECS	615 390 059 0

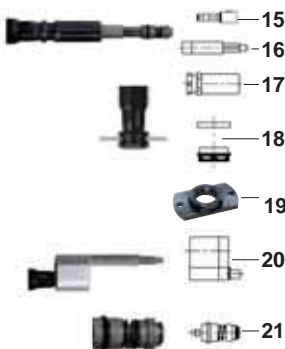

Spring Loaded Shafts and Bearings Support for ECS-M20/ECSF

15 Bit Adaptor	103782
16 Spring Loaded Shaft 25mm (1") stroke, 3/8" Sq Drive	108342
17 Shaft Support and Nose Mount	108412

Nose Mounts for ECS-M20/ECSF

18 Nose Mount	205 052 876 3
19 Flange	205 052 875 3

Offset Head and Spring Loaded Shaft for ECS-M20/ECSF

16 Spring loaded shaft 25mm (1") stroke, 3/8" square drive	108352
20 Offset Head, Offset 30mm (1.18")	384993

Screwdriver Bit Adaptor for ECS/ECSA/ECS-M20/ECSF

21 3/8" Square to 1/4" HexPower Adaptor	108322
---	--------

ECS / ECP / ECA / ECD



Cable for ECP / ECA / ECD

Cable length:	3m (9.8ft)	5m (16ft)	10m (32.8ft)	15m (49.2ft)
• Nutrunners cable	615 917 461 0	615 917 462 0	615 917 464 0	615 917 465 0
• Extension cable for ECS also		615 917 222 0	615 917 224 0	

Sockets Tray & Bits Tray

• Socket tray (sockets not supplied)				615 936 005 0
• Bit tray (bits not included)				615 929 025 0

Cable length:	1m (3.3ft)	2m (6.4ft)	5m (16ft)	10m (32.8ft)	15m (49.2ft)
• Cable for socket tray	615 917 241 0		615 917 242 0	615 917 244 0	615 917 245 0
• Cable for bit tray		615 917 535 0			

Reporting Box

• Reporting Box					615 936 001 0
-----------------	--	--	--	--	---------------

MC

OPTIONAL ACCESSORIES

PART NO.

• Motor/in-line connector assembly kit for MC35-10 to MC51-20	615 396 198 0
---	---------------

Transducer-holder from MC tool

• 3/8" square drive MC35/MC38	615 396 426 0
• 1/2" square drive MC51-10	615 396 427 0

Cable for MC tools

Cable length:	5m (16ft)	10m (32.8ft)	15m (49.2ft)
• Tool cable	615 917 232 0	615 917 234 0	615 917 235 0
• Tool extension cable	615 917 222 0	615 917 224 0	



Advanced controller for SLB screwdrivers

Flexible speed

- Adjustment between High/Low

Slow start Phase included

Legend
 Sp Speed during slow start phase
 Rc Duration of the slow start phase
 a Nominal free speed of tool
 t Time

Protection of The parameters

- Setting locked by key

Batch counting

- Incremental or decremental counting up to 99
- Sequence up to 5 batches

Universal

- Compatible with all the SLB range



INPUTS AND OUTPUTS FOR PLC COMMUNICATION

Input: Batch Enable
Batch Clear

Output: Tightening OK
Tightening NOK
Batch OK

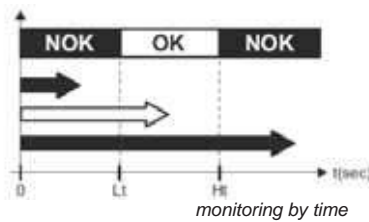

START-UP KIT to be ordered with the controller

Including: **Power cable and plug**

PLUG	DESCRIPTION	PART NO.
A	European	615 917 201 0
B	US	615 917 203 0
C	UK	615 917 202 0
D	Chinese	615 917 206 0

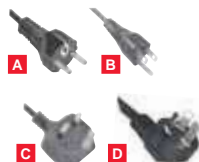

PIC REF	MODEL	PART NUMBER	LENGHT		DIMENSIONS WIDHT		HEIGHT		WEIGHT		VOLTAGE VAC	COMPATIBLE TOOLS
			mm	In	mm	In	mm	In	kg	lb		
A	ESP1	615 932 635 0	160	6.3	75	2.95	55	2.17	0.50	1.1	100-240	SLB003/012/020
B	ESP1-HT	615 932 637 0	213	8.4	131	5.20	65	2.60	1.80	3.9	100-240	SLB030/050
C	ESP1-A	615 932 662 0	247	9.7	130	5.12	100	3.93	2.40	5.3	100-240	ALL SLB RANGE



Low Voltage Screwdriver with clutch shut off - SLB



Flexibility

Installation by clamping in the top or in the front by a torque fixing ring

ESD Certification

Dedicated version for Electrostatic discharge component protection

Productivity

- Speed up to 2000 rpm
- Maintenance free thanks to brushless motor

Ergonomy

- Soft Rubber grip
- Low noise level <70dB(A)

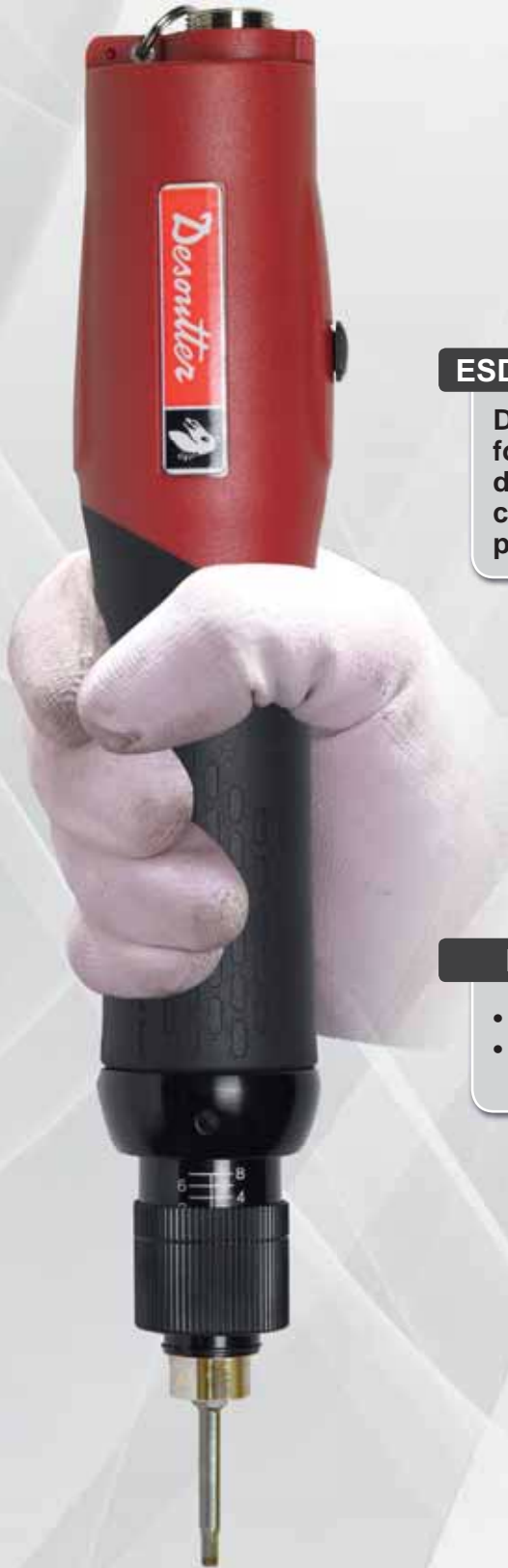

Standard & ESD Version - SLB



0.02 to 4.9 Nm (0.18 to 44.4 in.lb) - 750 to 2000 rpm



A



E



B



F



C



G



D



H



I

Accessories: see page 79

PIC REF	MODEL	PART NUMBER	OUTPUT HEX	FREE SPEED		TORQUE RANGE		LENGTH		WEIGHT		VOLTAGE VDC	CONTROLLER
				in	Hi rpm	Lo rpm	Nm	in.lb	mm	in	kg		
LEVER START - LOW VOLTAGE - CLUTCH CONTROL - SHUT OFF													
I	SLB003-L1000-S4Q	615 165 625 0	1/4	1000	750	0.02-0.35	0.18-3.1	182	7.2	0.38	0.34	32	ESP1
A	SLB012-L1000-S4Q-NE	615 165 713 0	1/4	1000	750	0.15-1.2	1.33-10.6	245	9.6	0.58	1.28	32	ESP1
E	SLB012-L1000-S4Q	615 165 565 0	1/4	same performance and characteristics with ESD compatibility									
A	SLB012-L2000-S4Q-NE	615 165 714 0	1/4	2000	1500	0.15-1.2	1.33-10.6	245	9.6	0.58	1.28	32	ESP1
E	SLB012-L2000-S4Q	615 165 566 0	1/4	same performance and characteristics with ESD compatibility									
A	SLB020-L1000-S4Q-NE	615 165 715 0	1/4	1000	750	0.29-1.9	2.57-16.8	245	9.6	0.58	1.28	32	ESP1
E	SLB020-L1000-S4Q	615 165 567 0	1/4	same performance and characteristics with ESD compatibility									
B	SLB030-L1000-S4Q-NE	615 165 720 0	1/4	1000	750	1.00-2.9	8.80-25.7	283	11.1	0.80	1.76	40	ESP1-HT
F	SLB030-L1000-S4Q	615 165 619 0	1/4	same performance and characteristics with ESD compatibility									
B	SLB030-L2000-S4Q-NE	615 165 719 0	1/4	2000	1500	1.00-2.9	8.80-25.7	283	11.1	0.80	1.76	40	ESP1-HT
F	SLB030-L2000-S4Q	615 165 620 0	1/4	same performance and characteristics with ESD compatibility									
B	SLB050-L1000-S4Q-NE	615 165 721 0	1/4	1000	750	2.00-4.9	17.7-44.4	283	11.1	0.80	1.76	40	ESP1-HT
F	SLB050-L1000-S4Q	615 165 621 0	1/4	same performance and characteristics with ESD compatibility									
PUSH START - LOW VOLTAGE - CLUTCH CONTROL - SHUT OFF													
C	SLB012-A1000-S4Q-NE	615 165 716 0	1/4	1000	750	0.15-1.2	1.33-10.6	245	9.6	0.58	1.28	32	ESP1
G	SLB012-A1000-S4Q	615 165 568 0	1/4	same performance and characteristics with ESD compatibility									
C	SLB012-A2000-S4Q-NE	615 165 717 0	1/4	2000	1500	0.15-1.2	1.33-10.6	245	9.6	0.58	1.28	32	ESP1
G	SLB012-A2000-S4Q	615 165 569 0	1/4	same performance and characteristics with ESD compatibility									
C	SLB020-A1000-S4Q-NE	615 165 718 0	1/4	1000	750	0.29-1.9	2.57-16.8	245	9.6	0.58	1.28	32	ESP1
G	SLB020-A1000-S4Q	615 165 570 0	1/4	same performance and characteristics with ESD compatibility									
D	SLB030-A1000-S4Q-NE	615 165 722 0	1/4	1000	750	1.00-2.9	8.80-25.7	283	11.1	0.80	1.76	40	ESP1-HT
H	SLB030-A1000-S4Q	615 165 622 0	1/4	same performance and characteristics with ESD compatibility									
D	SLB030-A2000-S4Q-NE	615 165 723 0	1/4	2000	1500	1.00-2.9	8.80-25.7	283	11.1	0.80	1.76	40	ESP1-HT
H	SLB030-A2000-S4Q	615 165 623 0	1/4	same performance and characteristics with ESD compatibility									
D	SLB050-A1000-S4Q-NE	615 165 724 0	1/4	1000	750	2.00-4.9	17.7-44.4	283	11.1	0.80	1.76	40	ESP1-HT
H	SLB050-A1000-S4Q	615 165 624 0	1/4	same performance and characteristics with ESD compatibility									

NE = No ESD Conformity

High value, simple solution - SLK

Flexible

- Integrated ring for quick installation of vertical suspension bail
- Tool-free torque adjustment
- Reverse action switch with stop position

Productive

- Ventilation slots for cool operation
- Linear torque adjustment with external chuck

Easy to maintain

- Simple maintenance thanks to quick brush replacement
- Spare brushes included

Comfortable

- Long, rounded trigger with easy access for operator's hand
- Soft rubber grip provides non-slip operation
- Flared shape and conical cross section give superior hand comfort during operation
- Finger stop reduces risk of hand slip off and allows the operator to quickly position hand on the tool and remain focussed on the application.



ESD CERTIFIED



Adapted to electronics and appliance assembly. Special dedicated SLK* low-voltage screwdrivers are ESD certified to ensure protection of electronic components.

* Certified models/ SLK022, SLK031, SLK047

Low Voltage screwdrivers - SLK

0.02 to 4.7 Nm (0.18 to 41.6 in.lb) - 530 to 1000 rpm



Power Controllers

PIC REF	MODEL	PART NUMBER	DESCRIPTION	WIDTH		DIMENSIONS HEIGHT		DEPTH		WEIGHT	
				mm	in.	mm	in.	mm	in.	kg	lb
E	ESP1	615 932 635 0	1 screwdriver - Input 100-240V	75	2.95	55	2.17	160	6.30	0.5	1.1
F	ESP2	615 932 636 0	2 screwdrivers - Input 100-240V	118	4.65	85	3.35	210	8.27	2.5	5.5

START-UP KIT to be ordered with the controller
Including: **Power cable and plug**

PLUG	DESCRIPTION	PART NO.
A	European	615 917 201 0
B	US	615 917 203 0
C	UK	615 917 202 0
D	Chinese	615 917 206 0

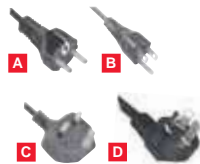

Recommended duty cycle, maximum 15 screws per minute

Accessories: see page 79

PIC REF	MODEL	PART NUMBER	OUTPUT HEX	FREE SPEED			TORQUE RANGE		LENGTH		WEIGHT		VOLTAGE VDC	CONTROLLER	ESD
				in.	Hi rpm	Lo rpm	Nm	in.lb	mm	in.	kg	lb			

PUSH START - LOW VOLTAGE - CLUTCH CONTROL - SHUT OFF

A	SLK011-A1000-S4Q	615 165 257 0	1/4	1000	700	0.10-1.18	0.88-10.4	218	8.6	0.48	1.06	24 or 32	ESP1 or 2	NO
A	SLK015-A1000-S4Q	615 165 258 0	1/4	1000	700	0.29-1.57	2.57-13.9	218	8.6	0.48	1.06	24 or 32	ESP1 or 2	NO
•	SLK017-A1000-S4Q	615 165 562 0	1/4	1000	700	0.39-1.76	3.45-15.6	260	10.2	0.60	1.32	24 or 32	ESP1 or 2	NO
•	SLK022-A1000-S4Q*	615 165 473 0	1/4	1000	700	0.60-2.25	5.31-19.9	308	12.1	0.69	1.52	24 or 32	ESP1 or 2	YES
•	SLK023-A750-S4Q	615 165 563 0	1/4	750	520	0.59-2.35	5.22-20.8	260	10.2	0.60	1.32	24 or 32	ESP1 or 2	NO
•	SLK029-A530-S4Q	615 165 564 0	1/4	530	370	0.78-2.94	6.9-26.0	260	10.2	0.60	1.32	24 or 32	ESP1 or 2	NO
•	SLK031-A750-S4Q*	615 165 474 0	1/4	750	500	1.00-3.14	8.85-27.8	308	12.1	0.69	1.52	24 or 32	ESP1 or 2	YES
•	SLK047-A530-S4Q*	615 165 475 0	1/4	530	350	1.50-4.70	13.28-41.6	308	12.1	0.69	1.52	24 or 32	ESP1 or 2	YES

LEVER START - LOW VOLTAGE - CLUTCH CONTROL - SHUT OFF

B	SLK003-L1000-S4Q	615 165 252 0	1/4	1000	700	0.02-0.34	0.18-3.01	224	8.8	0.27	0.59	24 or 32	ESP1 or 2	NO
B	SLK007-L1000-S4Q	615 165 253 0	1/4	1000	700	0.05-0.69	0.44-6.11	224	8.8	0.27	0.59	24 or 32	ESP1 or 2	NO
B	SLK010-L670-S4Q	615 165 254 0	1/4	670	470	0.10-0.98	0.88-8.67	224	8.8	0.27	0.59	24 or 32	ESP1 or 2	NO
•	SLK011-L1000-S4Q	615 165 255 0	1/4	1000	700	0.10-1.18	0.88-10.4	239	9.4	0.48	1.06	24 or 32	ESP1 or 2	NO
•	SLK015-L1000-S4Q	615 165 256 0	1/4	1000	700	0.29-1.57	2.57-13.9	239	9.4	0.48	1.06	24 or 32	ESP1 or 2	NO
•	SLK017-L1000-S4Q	615 165 559 0	1/4	1000	700	0.39-1.76	3.45-15.6	260	10.2	0.60	1.32	24 or 32	ESP1 or 2	NO
C	SLK022-L1000-S4Q*	615 165 470 0	1/4	1000	700	0.60-2.25	5.31-19.9	308	12.1	0.70	1.55	24 or 32	ESP1 or 2	YES
•	SLK023-L750-S4Q	615 165 560 0	1/4	750	520	0.59-2.35	5.22-20.8	260	10.2	0.60	1.32	24 or 32	ESP1 or 2	NO
•	SLK029-L530-S4Q	615 165 561 0	1/4	530	370	0.78-2.94	6.9-26.0	260	10.2	0.60	1.32	24 or 32	ESP1 or 2	NO
•	SLK031-L750-S4Q*	615 165 471 0	1/4	750	500	1.00-3.14	8.85-27.8	308	12.1	0.70	1.55	24 or 32	ESP1 or 2	YES
•	SLK047-L530-S4Q*	615 165 472 0	1/4	530	350	1.50-4.70	13.28-41.6	308	12.1	0.70	1.55	24 or 32	ESP1 or 2	YES

ESP C / ESP CA

Advanced controller SLC range



Auto stop after elapsed time and auto reverse

OK/NOK with rehit protection

I/O for integration with PLC for multiple functions

Easy to use Flexible keypad Multi languages

Speed control at all steps of operation: start, rundown and final phase

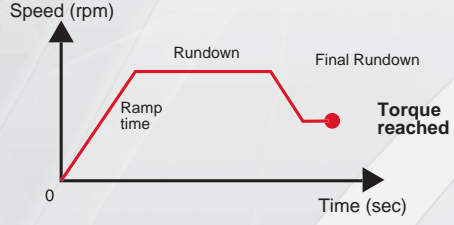

Replace several tools by one

- Multi torque strategy

User friendly interface

- Avoid time and Energy lost in programming

Automatic sequence Up to 8 programs

POKE YOKE & Fastening Assurance System

I/O for integration with PLC & multiple functions

USB key Results saving Statistics

High Torque Phase (HLT) For all Self Tapping/ Cutting applications

START-UP KIT to be ordered with the controller Including: **Power cable and plug**

PLUG	DESCRIPTION	PART NO.
A	European	615 917 201 0
B	US	615 917 203 0
C	UK	615 917 202 0
D	Chinese	615 917 206 0



PIC REF	MODEL	PART NUMBER	TORQUE RANGE		SUPPLY VOLTAGE	WIDTH		DIMENSIONS HEIGHT		DEPTH		WEIGHT	
			Nm	in.lb		mm	in.	mm	in.	mm	in.	kg	lb
A	ESP C 220V	615 165 480 0	0.5-15	4.4-132.7	AC 230V 50Hz	195	7.7	89	3.5	154	6.0	3.4	7.4
A	ESP C 110V	615 165 484 0	0.5-15	4.4-132.7	AC 120V 60Hz	195	7.7	89	3.5	154	6.0	3.4	7.4
A	ESP C LT 220V	615 165 481 0	0.5-7.0	4.4-61.9	AC 230V 50Hz	195	7.7	89	3.5	154	6.0	3.4	7.4
A	ESP C LT 110V	615 165 485 0	0.5-7.0	4.4-61.9	AC 120V 60Hz	195	7.7	89	3.5	154	6.0	3.4	7.4
B	ESP CA 220V	615 165 482 0	-	-	AC 230V 50 Hz	208	8.2	120	4.7	206	8.1	3.4	7.5
B	ESP CA LT 220V	615 165 483 0	-	-	AC 230V 50 Hz	208	8.2	120	4.7	206	8.1	3.4	7.5
B	ESP CA 110V	615 165 486 0	-	-	AC 120V 60 Hz	208	8.2	120	4.7	206	8.1	3.4	7.5
B	ESP CA LT 110V	615 165 487 0	-	-	AC 120V 60 Hz	208	8.2	120	4.7	206	8.1	3.4	7.5

High power screwdrivers - SLC

Torque Range

Performance of Electric Screwdrivers - Series SLC

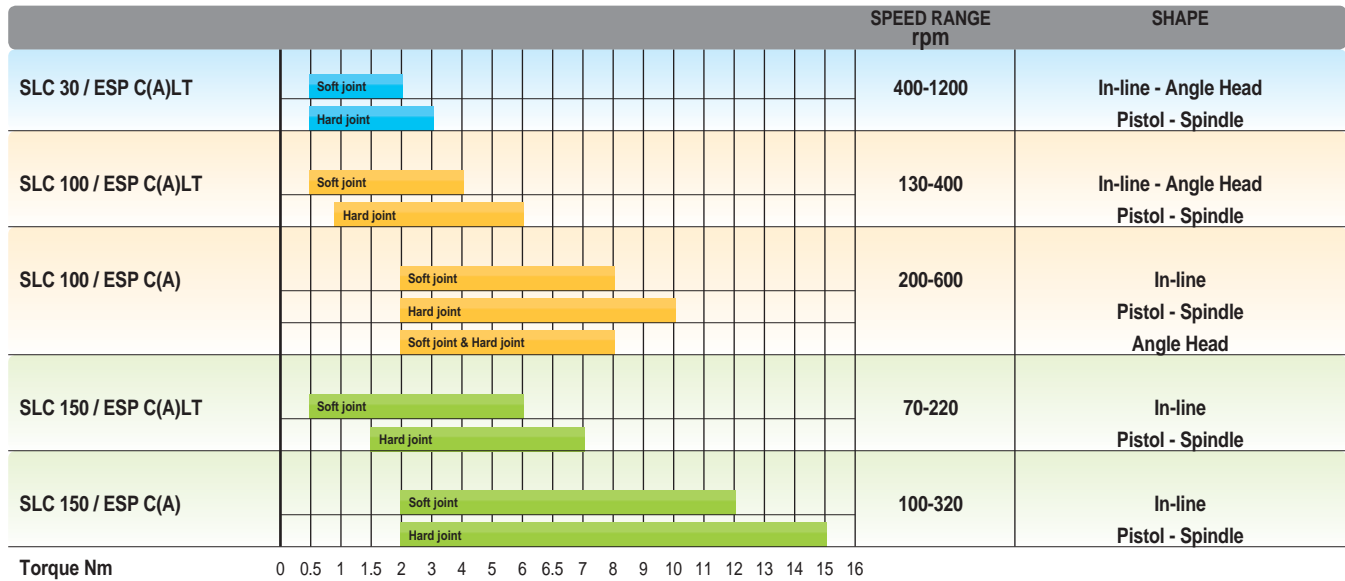

In-line and Angle head screwdrivers - SLC



0.5 to 15 Nm (4.4 to 132.7 in.lb) - 70 to 1200 rpm

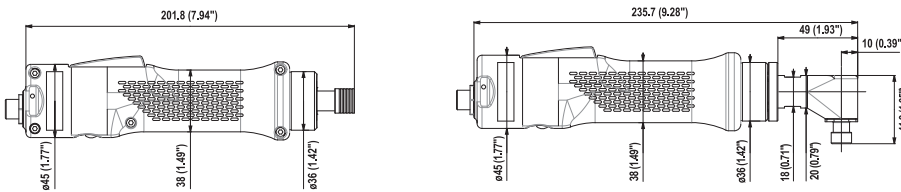

Accessories: see page 79

PIC REF	MODEL	PART NUMBER	OUTPUT HEX	FREE SPEED	TORQUE RANGE				WEIGHT		CONTROLLER	
					SOFT	TORQUE SOFT	HARD	HARD	kg	lb		
				in.	rpm	Nm	in.lb	Nm	in.lb	kg	lb	
IN-LINE - LOW VOLTAGE - CURRENT CONTROL - SHUT OFF												
A	SLC030-L1200-C4Q	615 165 500 0	1/4	400-1200	0.5-2	4.4-17.7	0.6-3	5.3-26.5	0.5	1.1	ESP C(A) LT	
A	SLC100-L600-C4Q	615 165 466 0	1/4	130-400	0.5-4	4.4-35.4	0.8-6	7.1-53.1	0.5	1.1	ESP C(A) LT	
A	SLC100-L600-C4Q	615 165 466 0	1/4	200-600	2.0-8	17.7-70.8	2.0-10	17.7-88.5	0.5	1.1	ESP C(A)	
A	SLC150-L320-C4Q	615 165 467 0	1/4	70-220	0.5-6	4.4-53.1	1.5-7	13.3-61.9	0.5	1.1	ESP C(A) LT	
A	SLC150-L320-C4Q	615 165 467 0	1/4	100-320	2.0-12	17.7-106.2	2.0-15	17.7-132.7	0.5	1.1	ESP C(A)	
ANGLE HEAD - LOW VOLTAGE - CURRENT CONTROL - SHUT OFF												
B	SLC030-L1200-C90A4H	615 165 478 0	1/4	400-1200	0.5-2	4.4-17.7	0.6-3	5.3-26.5	0.7	1.5	ESP C(A) LT	
B	SLC100-L600-C90A4H	615 165 479 0	1/4	130-400	0.5-4	4.4-35.4	0.8-6	7.1-53.1	0.7	1.5	ESP C(A) LT	
B	SLC100-L600-C90A4H	615 165 479 0	1/4	200-600	2.0-8	17.7-70.8	2.0-10	17.7-88.5	0.7	1.5	ESP C(A)	

Pistol grip screwdrivers - SLC

0.5 to 15 Nm (4.4 to 132.7 in.lb) - 70 to 1200 rpm

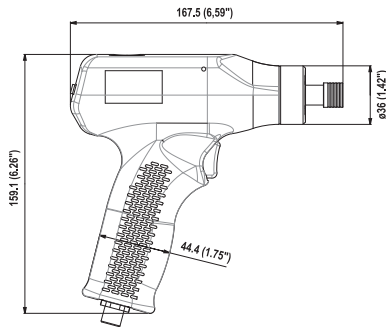

PIC REF	MODEL	PART NUMBER	OUTPUT HEX	FREE SPEED	TORQUE RANGE		TORQUE RANGE		WEIGHT		CONTROLLER
			in.	rpm	SOFT Nm	SOFT in.lb	HARD Nm	HARD in.lb	kg	lb	
PISTOL GRIP - LOW VOLTAGE - CURRENT CONTROL - SHUT OFF											
A	SLC030-P1200-C4Q	615 165 488 0	1/4	400-1200	0.5-2	4.4-17.7	0.6-3	5.3-26.5	0.6	1.3	ESP C(A) LT
A	SLC100-P600-C4Q	615 165 462 0	1/4	130-400	0.5-4	4.4-35.4	0.8-6	7.1-53.1	0.6	1.3	ESP C(A) LT
			1/4	200-600	2.0-8	17.7-70.8	2.0-10	17.7-88.5	0.6	1.3	ESP C(A)
A	SLC150-P320-C4Q	615 165 463 0	1/4	70-220	0.5-6	4.4-53.1	1.5-7	13.3-61.9	0.6	1.3	ESP C(A) LT
			1/4	100-320	2.0-12	17.7-106.2	2.0-15	17.7-132.7	0.6	1.3	ESP C(A)
PISTOL GRIP WITH TOP CONNECTOR - CURRENT CONTROL - SHUT OFF											
B	SLC030-T1200-C4Q	615 165 489 0	1/4	400-1200	0.5-2	4.4-17.7	0.6-3	5.3-26.5	0.6	1.3	ESP C(A) LT
B	SLC100-T600-C4Q	615 165 464 0	1/4	130-400	0.5-4	4.4-35.4	0.8-6	7.1-53.1	0.6	1.3	ESP C(A) LT
			1/4	200-600	2.0-8	17.7-70.8	2.0-10	17.7-88.5	0.6	1.3	ESP C(A)
B	SLC150-T320-C4Q	615 165 465 0	1/4	70-220	0.5-6	4.4-53.1	1.5-7	13.3-61.9	0.6	1.3	ESP C(A) LT
			1/4	100-320	2.0-12	17.7-106.2	2.0-15	17.7-132.7	0.6	1.3	ESP C(A)

SLC - Automation - Remote start

0.5 to 15 Nm (4.4 to 132.7 in.lb) - 70 to 1200 rpm

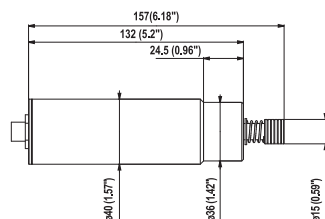

PIC REF	MODEL	PART NUMBER	OUTPUT HEX	FREE SPEED	TORQUE RANGE		TORQUE RANGE		WEIGHT		CONTROLLER
			in.	rpm	SOFT Nm	SOFT in.lb	HARD Nm	HARD in.lb	kg	lb	
AUTOMATION - REMOTE START											
A	SLC030-F1200-C4Q	615 165 490 0	1/4	400-1200	0.5-2	4.4-17.7	0.6-3	5.3-26.5	0.5	1.1	ESP C(A) LT
A	SLC100-F600-C4Q	615 165 468 0	1/4	130-400	0.5-4	4.4-35.4	0.8-6	7.1-53.1	0.5	1.1	ESP C(A) LT
			1/4	200-600	2.0-8	17.7-70.8	2.0-10	17.7-88.5	0.5	1.1	ESP C(A)
A	SLC150-F320-C4Q	615 165 469 0	1/4	70-220	0.5-6	4.4-53.1	1.5-7	13.3-61.9	0.5	1.1	ESP C(A) LT
			1/4	100-320	2.0-12	17.7-106.2	2.0-15	17.7-132.7	0.5	1.1	ESP C(A)

SLB / SLK / SLC

ACCESSORIES INCLUDED

ITEM	SLB	SLK	SLC
• Suspension bail			615 360 222 0
• Torque fixing ring for SLB003	615 225 053 0		
• Torque fixing ring for SLB012/020	615 225 104 0		
• Torque fixing ring for SLB030/050	615 225 105 0		
• Tool / Controller cable L = 2.5m (8.2ft)	-		615 360 223 0
• Cable L = 1.83m (6ft)	615 397 416 0	615 360 001 0	

OPTIONAL ACCESSORIES

ITEM	SLB	SLK	SLC
1 Side Handle		615 396 861 0	615 397 016 0
2 Color ring (3)			615 397 008 5
3 Torque fixing ring for SLK003 / 007 / 010		615 225 053 0	
3 Torque fixing ring for SLK011 / 015		615 225 054 0	
3 Torque fixing ring for SLK017 / 023 / 029		615 225 096 0	
3 Torque fixing ring for SLK022 / 031 / 047		615 225 090 0	
4 Adaptor for SLK003 / 007 / 010		615 225 065 0	
4 Adaptor for SLK011 / 015		615 225 066 0	
4 Adaptor for SLK022 / 031 / 047		438963	
• Kit of 3 color fixing ring for SLK022 / 031 / 047		615 225 091 0	
• Cable extension L = 2m (6.6ft)			615 917 593 0
5 Spiral cable L = 2m (6.6ft)			615 917 594 0
• M20 adaptor			615 567 132 0
• Cable L = 2.74m (9ft)		615 360 217 0	
6 Slow-start control module - SSCM1		615 932 644 0	
7 Control Box	615 165 627 0		
8 Pistol grip (Trigger) for SLB030/050	615 397 918 0		
8 Pistol grip (Push) for SLB030/050	615 397 919 0		
8 Pistol grip (Push) for SLB012/020	77562		
• Cable, 10m (32.8 ft)	615 360 379 0		
• Wall fixing plate for ESP1-HT	615 571 085 5		
• Clamp ring for SLB012/020	615 397 814 0		
• Clamp ring for SLB030/050	615 397 815 0		
• Adaptor M20 SLB012/020	615 548 151 5		
• Adaptor M20 SLB 030/050	615 548 152 5		
9 Angle head for SLB012/020	615 398 033 0		
9 Angle head for SLB030/050	615 398 034 0		
10 Bit tray			615 936 068 0
11 Switch box			615 936 069 0
Spring Loaded Shafts and Bearings Support for ECS-M20/ECSF			
12 Bit Adaptor			103782
13 Spring Loaded Shaft 25mm (1") stroke, 3/8" Sq Drive			108342
14 Shaft Support and Nose Mount			108412
Nose Mounts for ECS-M20/ECSF			
15 Nose Mount			205 052 876 3
16 Flange			205 052 875 3
Offset Head and Spring Loaded Shaft for ECS-M20/ECSF			
13 Spring loaded shaft 25mm (1") stroke, 3/8" square drive			108352
17 Offset Head, Offset 30mm (1.18")			384993
Screwdriver Bit Adaptor for ECS/ECSA/ECS-M20/ECSF			
18 3/8" Square to 1/4" HexPower Adaptor			108322
Balancers and Holster			
19 Spring Suspension Balancer		50522	50522
20 Reaction Free Self Lock Balancer		54422	54422
21 Bench Mounted Swing Arm		66542	66542
22 Tool holster DTH-42		107892	107892
Bench Stands (for more information, see pages 136-143)			
23 D53-12 Linear arm, (tool clamp included)	615 810 701 0	615 810 701 0	615 810 701 0
23 D53-25 Linear arm, (tool clamp included)	615 810 702 0	615 810 702 0	615 810 702 0
23 D53-25X Linear arm, (tool clamp included)	615 810 703 0	615 810 703 0	615 810 703 0
24 D53-12S Folder arm, (tool clamp included)	615 810 707 0	615 810 707 0	615 810 707 0
24 D53-25S Folder arm, (tool clamp included)	615 810 708 0	615 810 708 0	615 810 708 0
25 D57 Balancing Arm		408903	408903
25 D57X Balancing Arm, extended reach		408913	408913
26 D58 Balancing Arm with Swivel		408923	408923
• Tool clamp (nose mount)		615 396 614 0	615 396 614 0
• Tool clamp (top mount)			615 396 629 0
Telescopic Reaction Arm			
27 TRA12 Telescopic Reaction Arm		See page 141	
27 TRA25 Telescopic Reaction Arm		See page 141	





Pneumatic fastening tools

Shut Off, Non Shut Off, Direct Drive, Automatic Reverse



T shape grip for better balance to enhance operator comfort

Powerful, efficient, Dryline™ motor

Clutch and motor prolonging tool life

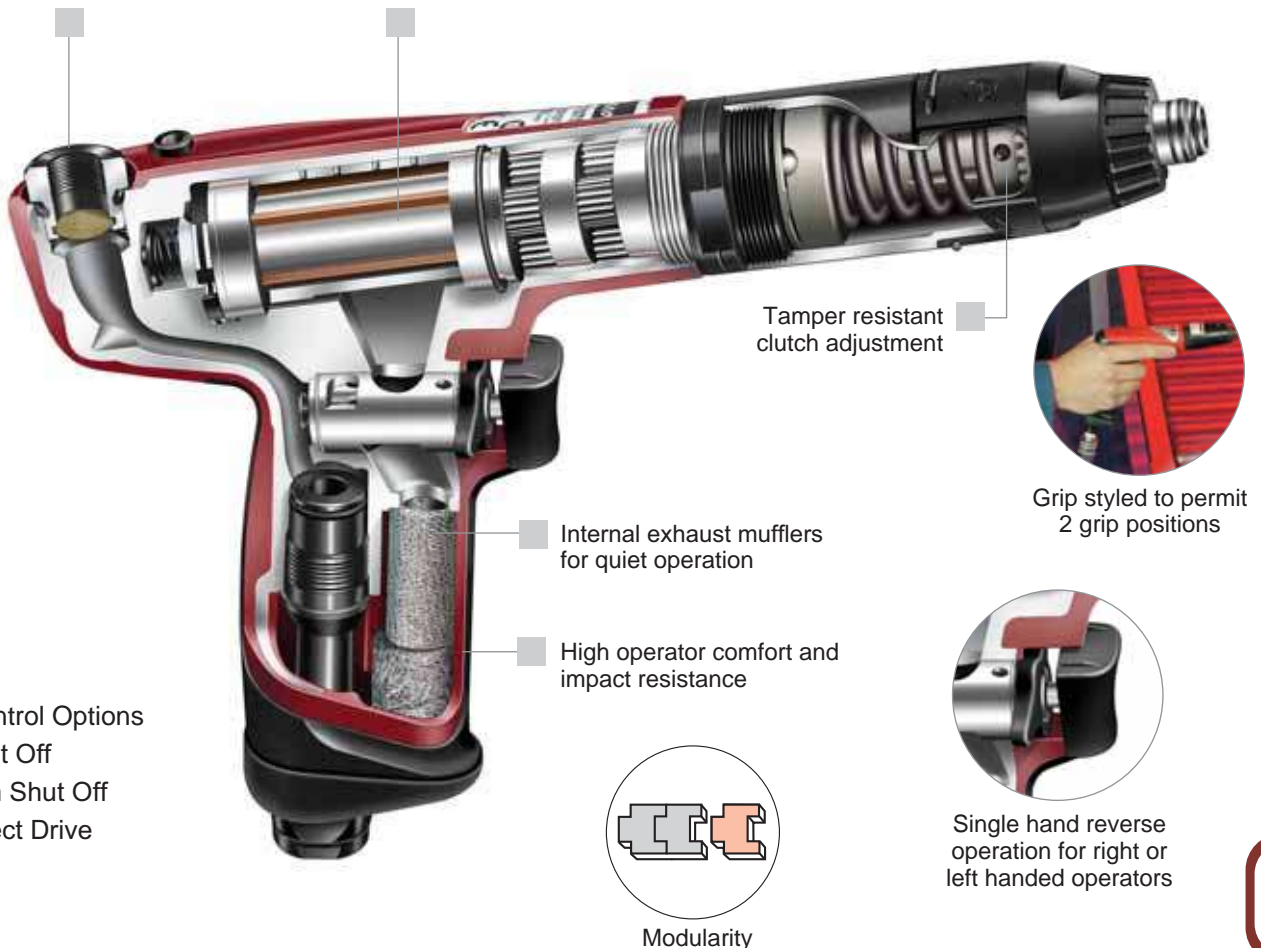





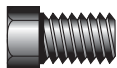
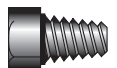
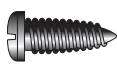
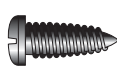
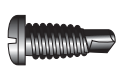
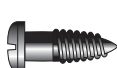

Tool Selection

Criteria

- Type of Fastener/Component
- Joint integrity
- Torque Required
- Tool Orientation and Operator Reference
- Productivity
- Access

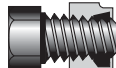
Type of Fastener/Component

FASTENER/COMPONENT	RECOMMENDED TOOL TYPE
Machine Screw / Nut 	Shut Off / Impulse / Non Shut Off
Thread Rolling / Forming 	Shut Off / HLT / Impulse / Direct Drive
Self Tapping 	Non Shut Off / HLT / Direct Drive
Self Tapping in Plastic / Thin Materials 	Shut Off / HLT
Self Drilling 	Non Shut Off / HLT / Direct Drive
Wood Screws 	Non Shut Off / Direct Drive

FASTENER/COMPONENT	RECOMMENDED TOOL TYPE
Screws with Adhesive 	HLT / Non Shut Off / Impulse
Self Lock Nuts 	HLT / Non Shut Off / Impulse
Misaligned Holes 	HLT
Variable Size Holes 	HLT
Fragile Components 	HLT / Low Voltage Screwdrivers



Tool Selection

Fastener Torque Values

ISO	MACHINE SCREWS					THREAD FORMING/ ROLLING SCREWS
	4.6	5.8	8.8	10.9	12.9	8.8
THREAD SIZE	RECOMMENDED TORQUE (Nm)					RECOMMENDED TORQUE (Nm)
M1.6	0.07	0.12	0.19	–	–	–
M2	0.15	0.24	0.38	–	–	0.5
M2.2	0.19	0.31	0.51	–	–	–
M2.5	0.28	0.48	0.77	–	–	–
M3	0.51	0.85	1.4	1.9	2.3	1.4
M3.5	0.80	1.34	2.2	3.0	3.6	–
M4	1.20	2.00	3.2	4.5	5.4	3.2
M5	2.40	4.00	6.4	9.0	10.7	6.5
M6	4.10	6.80	10.9	15.3	18.3	11
M8	9.80	16.3	26.1	36.8	44.1	26
M10	19.3	32.2	51.5	72	86.9	52
M12	33.6	56.0	90	126	151	91
M14	53.0	89.0	142	200	239	–
M16	82.0	136	218	307	368	–
M18	114	190	304	428	513	–
M20	160	266	426	598	718	–
M22	215	358	573	806	967	–

SELF TAPPING/DRILLING SCREWS	
THREAD SIZE	RECOMMENDED TORQUE (Nm)
ST2.2 (B2)	0.2
ST2.9 (B4)	1.0
ST3.5 (B6)	1.8
ST4.2 (B8)	2.9
ST4.8 (B10)	4.2
ST5.5 (B12)	6.7
ST6.3 (B14)	9.1

Conversion Factors

Nm x 141.6 = oz in
 Nm x 8.851 = in lb
 Nm x 0.73756 = ft lb
 Nm x 0.102 = kgf m/kpm
 Nm x 10.2 = kgf cm

Torque figures should be used as a guide only
 Table assumes fasteners are new, lightly lubricated and of a standard finish
 For lock nuts with a nylon insert, +10%
 Torque values are recommended values for a working pressure of 6,3 bar (90 PSIG)

For non metric threads please use the following data as a guide.

Recommended Maximum Torque Values – UNC Threads

THREAD SIZE	QUALITY P		QUALITY S		QUALITY T	
	Nm	ft.lb	Nm	ft.lb	Nm	ft.lb
1/4	5.43	4	10.3	7.6	11	8.2
5/16	11.2	8.3	21.3	15.7	23	16.9
3/8	19.9	14.7	37.9	27.9	40	30.2
7/16	31.9	23.5	60.7	44.8	65	48.31
1/2	48.8	36	92.7	68.4	100	73.8
9/16	70.4	51.9	134	98.8	144	106
5/8	97.4	71.8	185	136.4	200	147.5
3/4	178	131.3	338	249.3	364	268.5
7/8	279	205.8	530	391	572	422
1	418	308.3	795	586	858	633
1 1/8	593	437.4	1126	830	1216	897
1 1/4	837	617.3	1591	1173	1717	1266
1 3/8	1096	808.4	2083	1536	2248	1658
1 1/2	1456	1074	2767	2041	2987	2203

Recommended Maximum Torque Values – UNF Threads

THREAD SIZE	QUALITY P		QUALITY S		QUALITY T	
	Nm	ft.lb	Nm	ft.lb	Nm	ft.lb
1/4	6.3	4.6	11.9	8.8	12.9	9.5
5/16	12.5	9.2	23.8	17.5	25.7	18.9
3/8	22.7	16.7	43.2	31.9	46.6	34.4
7/16	35.9	26.5	68.2	50.3	73.6	54.3
1/2	55.4	40.9	105	77.4	114	84
9/16	79	58.3	150	111	162	119
5/8	111	81.9	210	155	227	167
3/4	195	144	370	273	399	294
7/8	309	228	587	433	634	468
1	459	339	873	644	942	695
1 1/8	667	492	1267	934	1368	1009
1 1/4	925	682	1757	1296	1896	1398
1 3/8	1252	923	2378	1754	2567	1893
1 1/2	1642	1211	3119	2300	3367	2482

Quality P = approximately ISO 4.6

Quality S/T = approximately ISO 8.8

Quality S = ANSI Grade 5



Productivity and Ergonomics

Access



90° Angle Heads



45° Angle Heads



Crowfoot
Open Ended Wrenches

Ergonomic Benefits

- Lightweight
- Short Length
- Light Start Load

Pistol options of 'P' or 'T' style to suit the application and operator preference

'Warm feel' friction grip



Single hand reverse operation for right and left handed operators without any modification

Contoured grip

Correct grip orientation

Tapered nose for improved visibility

Tamper resistant clutch adjustment



Contoured grip

Friction grip

Thrust bump

Tamper resistant clutch adjustment

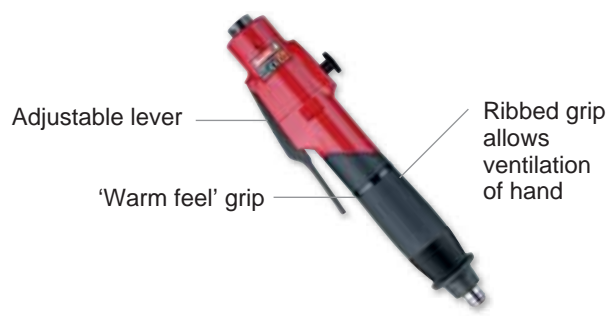

Adjustable lever

'Warm feel' grip

Ribbed grip allows ventilation of hand

For low vibration exposure and high productivity, select shut off tools where possible

Tool orientation and Operator preference



P Shape

Self Tapping/Forming/Cutting Screws
Multi orientation
Top air inlet
Requires balanced tool

Use P Shape - arm in line with body of tool for thrust
Use P Shape - allows wrist to rotate into position
Can only use T Shape
Use T Shape - especially with screwfeeder

Button Reverse versus Rotary Reverse

Rapid Reverse Required
Thread Chasing/Cleaning
Rivnuts/Threaded Fasteners
Long Periods in Reverse

Use button reverse
Use button reverse (auto reverse for blind holes)
Use auto reverse tools
Use rotary reverse

Push Start versus Lever Start

Fast Cycle Rate
Single Hand Operation Required
Need to Align/Position Components First

Use push start
Use push start
Use lever start or push + trigger start (SBP/SDP only)

Modularity

SD Series



Modularity, a concept for all Desoutter pneumatic screwdrivers range

Screwdriver Torque Ranges

Torque output of the range of shut off and non shut off screwdrivers is controlled by the type of spring in the clutch assembly

The overall torque range, together with that of the factory fitted spring on a soft joint to ISO5393 are listed in the tables on the following pages. The chart below provides an indication of the torque ranges for the optional colour coded clutch springs together with their respective part numbers (some are included with certain tools) As a general rule, the tool should be fitted with a spring which ensures the torque required falls within 20 to 80% of the operating range

Please note that the torque range of specific speed tools may alter slightly from that shown below and for this reason the chart should be used as a guide only

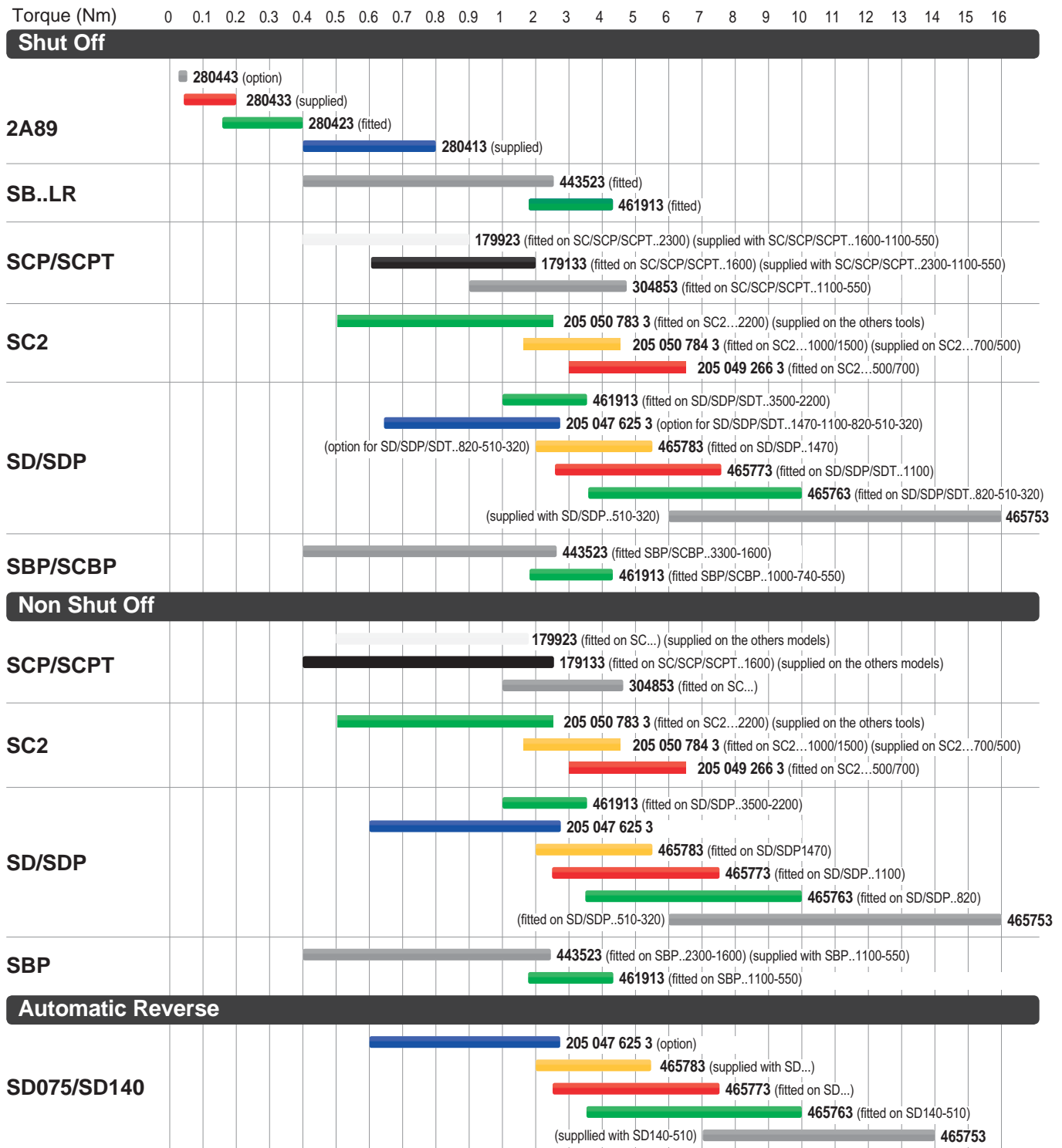

Tool Types and Torque Ranges

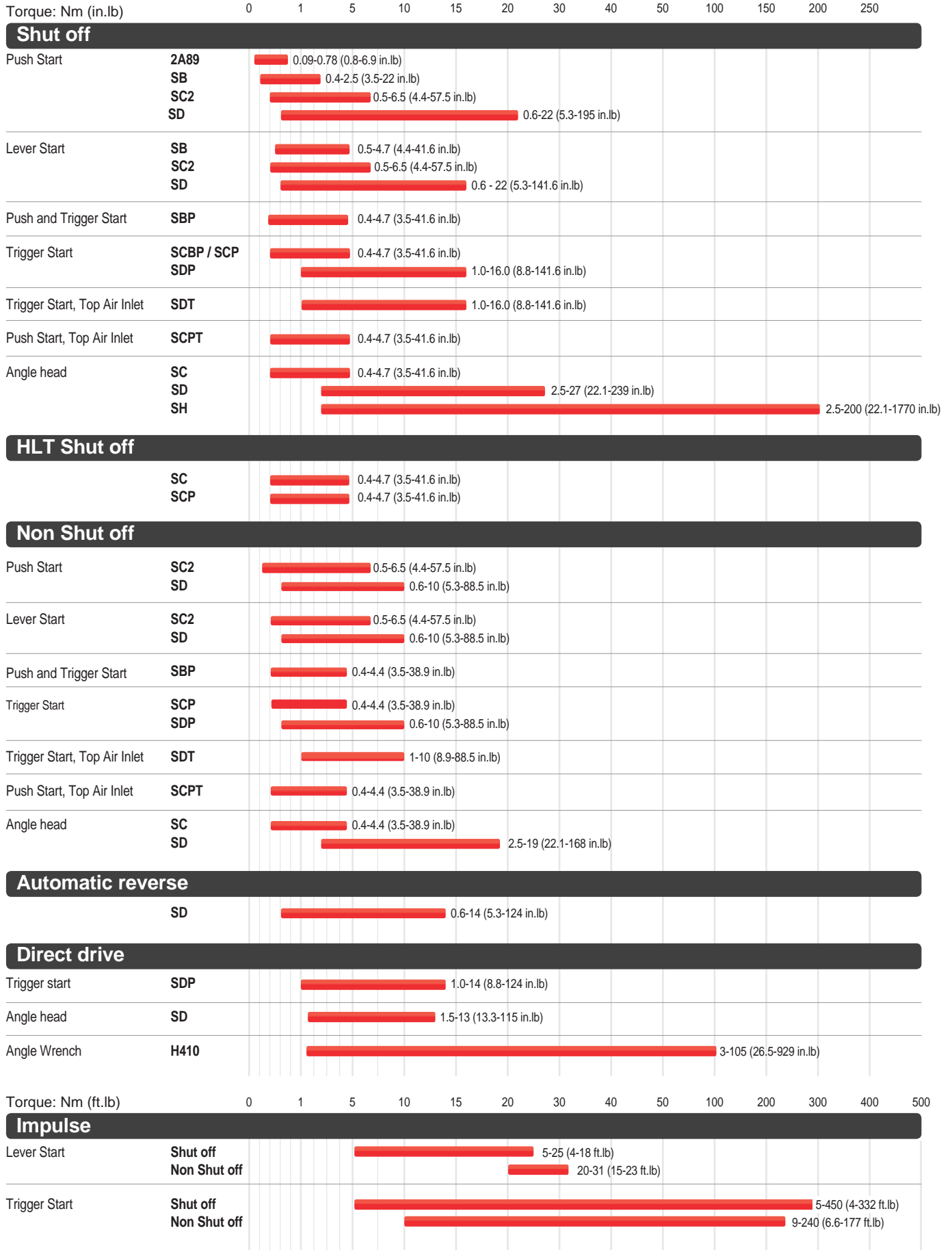

Screwdrivers - Shut off - Push start

0.09 to 16 Nm (0.8 to 142 in.lb) - 320 to 3500 rpm



Model	ø A mm (in.)	ø B mm (in.)	L mm (in.)
2A89..	27 (1.06)		178 (7)
SB..	32 (1.26)	36 (1.42)	197 (7.76)
SC2		37.4 (1.47)	245 (9.65)
SD023..3500	38.7 (1.52)	44 (1.73)	227 (8)
SD035..2200	38.7 (1.52)	44 (1.73)	227 (8)
SD055..1470	38.7 (1.52)	44 (1.73)	253 (10)
SD075..1100	38.7 (1.52)	44 (1.73)	253 (10)
SD100..820	38.7 (1.52)	44 (1.73)	253 (10)
SD140..510	38.7 (1.52)	44 (1.73)	253 (10)
SD160..320	38.7 (1.52)	44 (1.73)	253 (10)

Accessories: see page 104

Types B to C, 1/4" double ended and 5mm bit holder optional

PIC REF	MODEL	PART NUMBER	FREE SPEED	OUTPUT HEX	TORQUE RANGE		FITTED SPRING		WEIGHT		AIR FLOW		AIR INLET	HOSE INT. Ø	
					Nm	in.lb	Nm	in.lb	kg	lb.	l/s	cfm	in.	mm	in.
A	2A89-A-1300	1225434	1300	3mm	0.09-0.56	0.8-4.9	0.15-0.43	1.3-3.8	0.21	0.62	2.2	4.7	M5	3	1/8
A	2A89-A-700	1225514	700	3mm	0.09-0.75	0.8-6.6	0.15-0.43	1.3-3.8	0.21	0.62	2.2	4.7	M5	3	1/8
A	2A89-A-400	1225694	400	3mm	0.09-0.78	0.8-6.9	0.15-0.43	1.3-3.8	0.21	0.62	2.2	4.7	M5	3	1/8
A	2A89-A-1300	1223154	1300	1/4	0.09-0.56	0.8-4.9	0.15-0.43	1.3-3.8	0.21	0.62	2.2	4.7	M5	3	1/8
A	2A89-A-700	1223234	700	1/4	0.09-0.75	0.8-6.6	0.15-0.43	1.3-3.8	0.21	0.62	2.2	4.7	M5	3	1/8
A	2A89-A-400	1223314	400	1/4	0.09-0.78	0.8-6.9	0.15-0.43	1.3-3.8	0.21	0.62	2.2	4.7	M5	3	1/8
B	SB011-AB1600-S4Q	1460644	1600	1/4	0.4-1.1	3.5-9.7	0.4-1.1	3.5-9.7	0.42	0.93	4.1	8.7	1/8	5	3/16
B	SB015-AB1100-S4Q	1460634	1100	1/4	0.4-1.5	3.5-13	0.4-1.5	3.5-13	0.42	0.93	4.1	8.7	1/8	5	3/16
B	SB025-AB750-S4Q	1460624	750	1/4	0.4-2.5	3.5-22	0.4-2.5	3.5-22	0.42	0.93	4.1	8.7	1/8	5	3/16
B	SB025-AB500-S4Q	1460684	500	1/4	0.4-2.5	3.5-22	0.4-2.5	3.5-22	0.42	0.93	4.1	8.7	1/8	5	3/16
C	SB011-AR1600-S4Q	1460524	1600	1/4	0.4-1.1	3.5-9.7	0.4-1.1	3.5-9.7	0.42	0.93	4.1	8.7	1/8	5	3/16
C	SB015-AR1100-S4Q	1460514	1100	1/4	0.4-1.5	3.5-13	0.4-1.5	3.5-13	0.42	0.93	4.1	8.7	1/8	5	3/16
C	SB025-AR750-S4Q	1460504	750	1/4	0.4-2.5	3.5-22	0.4-2.5	3.5-22	0.42	0.93	4.1	8.7	1/8	5	3/16
C	SB025-AR500-S4Q	1460564	500	1/4	0.4-2.5	3.5-22	0.4-2.5	3.5-22	0.42	0.93	4.1	8.7	1/8	5	3/16
D	SC2-025-A2200-S4Q	205 147 269 4	2200	1/4	0.5-2.5	4.4-22	0.5-2.5	4.4-22.1	0.69	1.52	7.0	14.8	1/4	6	1/4
D	SC2-035-A1500-S4Q	205 147 268 4	1450	1/4	0.5-3.5	4.4-30.8	1.7-3.5	15.0-30.9	0.69	1.52	7.0	14.8	1/4	6	1/4
D	SC2-045-A1000-S4Q	205 147 267 4	1000	1/4	0.5-4.5	4.4-39.6	1.7-4.5	15.0-39.8	0.69	1.52	7.0	14.8	1/4	6	1/4
D	SC2-055-A700-S4Q	205 147 266 4	700	1/4	0.5-5.5	4.4-48.4	3.0-5.5	26.5-48.6	0.69	1.52	7.0	14.8	1/4	6	1/4
D	SC2-065-A500-S4Q	205 147 265 4	480	1/4	0.5-6.5	4.4-57.2	3.0-6.5	26.5-57.5	0.69	1.52	7.0	14.8	1/4	6	1/4
E	SD023-AB3500-S4Q	1462834	3500	1/4	1.0-2.3	8.9-20.3	1.0-2.3	8.9-20.3	0.73	1.61	8.7	18.4	1/4	10	3/8
E	SD035-AB2200-S4Q	1462824	2200	1/4	1.0-3.5	8.9-31	1.0-3.5	8.9-31	0.73	1.61	8.7	18.4	1/4	10	3/8
E	SD055-AB1470-S4Q	1462814	1470	1/4	0.6-5.5	5.3-48.7	2.0-5.5	17.7-48.7	0.89	1.96	8.7	18.4	1/4	10	3/8
E	SD075-AB1100-S4Q	1462804	1100	1/4	0.6-7.5	5.3-66.4	2.5-7.5	22.0-66.4	0.89	1.96	8.7	18.4	1/4	10	3/8
E	SD100-AB820-S4Q	1462794	820	1/4	0.6-10	5.3-88.5	3.5-10	31.0-88.5	0.89	1.96	8.7	18.4	1/4	10	3/8
E	SD140-AB510-S4Q	1462784	510	1/4	0.6-14	5.3-124	3.5-10	31.0-88.5	0.89	1.96	8.7	18.4	1/4	10	3/8
E	SD160-AB320-S4Q	1462774	320	1/4	0.6-16	5.3-142	3.5-10	31.0-88.5	0.89	1.96	8.7	18.4	1/4	10	3/8
F	SD023-AR3500-S4Q	1462764	3500	1/4	1.0-2.3	8.9-20.4	1.0-2.3	8.9-20.4	0.73	1.61	8.7	18.4	1/4	10	3/8
F	SD035-AR2200-S4Q	1462754	2200	1/4	1.0-3.5	8.9-31	1.0-3.5	8.9-31	0.73	1.61	8.7	18.4	1/4	10	3/8
F	SD055-AR1470-S4Q	1462744	1470	1/4	0.6-5.5	5.3-48.7	2.0-5.5	17.7-48.7	0.89	1.96	8.7	18.4	1/4	10	3/8
F	SD075-AR1100-S4Q	1462734	1100	1/4	0.6-7.5	5.3-66.4	2.5-7.5	22.1-66.4	0.89	1.96	8.7	18.4	1/4	10	3/8
F	SD100-AR820-S4Q	1462724	820	1/4	0.6-10	5.3-88.5	3.5-10	31.0-88.5	0.89	1.96	8.7	18.4	1/4	10	3/8
F	SD140-AR510-S4Q	1462714	510	1/4	0.6-14	5.3-124	3.5-10	31.0-88.5	0.89	1.96	8.7	18.4	1/4	10	3/8
F	SD160-AR320-S4Q	1462704	320	1/4	0.6-16	5.3-142	3.5-10	31.0-88.5	0.89	1.96	8.7	18.4	1/4	10	3/8

Screwdrivers - Shut off - Lever start

0.4 to 16 Nm (3.5 to 142 in.lb) - 320 to 3500 rpm



Easy integration with FAS3000 or POSCO



See page 66



See page 92

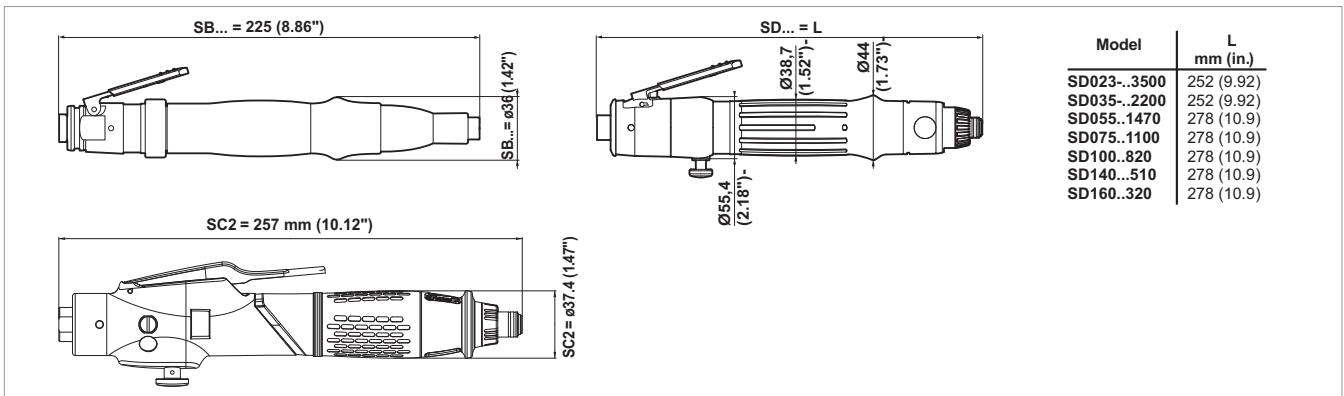

Accessories: see page 104

PIC REF	MODEL	PART NUMBER	FREE SPEED	OUTPUT HEX	TORQUE RANGE		FITTED SPRING		WEIGHT		AIR FLOW	AIR INLET	HOSE INT. Ø		
					Nm	in.lb	Nm	in.lb	kg	lb.	l/s	cfm	in.	mm	in.
A	SB021-LR2000-S4Q	205 147 509 4	2000	1/4	0.5-2.1	4.4-18.6	0.5-2.1	4.4-18.6	0.61	1.34	7.3	15.5	1/8	6	1/4
A	SB021-LR1400-S4Q	205 147 508 4	1400	1/4	0.5-2.1	4.4-18.6	0.5-2.1	4.4-18.6	0.61	1.34	7.3	15.5	1/8	6	1/4
A	SB043-LR1050-S4Q	205 147 507 4	1050	1/4	0.4-4.3	3.5-38	0.4-2.1	3.5-18.6	0.61	1.34	7.3	15.5	1/8	6	1/4
A	SB047-LR500-S4Q	205 147 506 4	500	1/4	0.4-4.7	3.5-41.6	0.4-2.1	3.5-18.6	0.61	1.34	7.3	15.5	1/8	6	1/4
B	SC2-025-L2200-S4Q	205 147 283 4	2200	1/4	0.5-2.5	4.4-22	0.5-2.5	4.4-22.1	0.69	1.52	7.0	14.8	1/4	6	1/4
B	SC2-035-L1500-S4Q	205 147 282 4	1450	1/4	0.5-3.5	4.4-30.8	1.7-3.5	15.0-30.9	0.69	1.52	7.0	14.8	1/4	6	1/4
B	SC2-045-L1000-S4Q	205 147 281 4	1000	1/4	0.5-4.5	4.4-39.6	1.7-4.5	15.0-39.8	0.69	1.52	7.0	14.8	1/4	6	1/4
B	SC2-055-L700-S4Q	205 147 280 4	700	1/4	0.5-5.5	4.4-48.4	3.0-5.5	26.5-48.6	0.69	1.52	7.0	14.8	1/4	6	1/4
B	SC2-065-L500-S4Q	205 147 279 4	480	1/4	0.5-6.5	4.4-57.2	3.0-6.5	26.5-57.5	0.69	1.52	7.0	14.8	1/4	6	1/4
C	SD023-LB3500-S4Q	1463094	3500	1/4	1.0-2.3	8.9-20.4	1.0-2.3	8.9-20.4	0.76	1.67	8.7	18.4	1/4	10	3/8
C	SD035-LB2200-S4Q	1463084	2200	1/4	1.0-3.5	8.9-31	1.0-3.5	8.9-31	0.76	1.67	8.7	18.4	1/4	10	3/8
C	SD055-LB1470-S4Q	1463074	1470	1/4	0.6-5.5	5.3-48.7	2.0-5.5	17.7-48.7	0.92	2.03	8.7	18.4	1/4	10	3/8
C	SD075-LB1100-S4Q	1463064	1100	1/4	0.6-7.5	5.3-66.4	2.5-7.5	22.1-66.4	0.92	2.03	8.7	18.4	1/4	10	3/8
C	SD100-LB820-S4Q	1463054	820	1/4	0.6-10	5.3-88.5	3.5-10	31.0-88.5	0.92	2.03	8.7	18.4	1/4	10	3/8
C	SD140-LB510-S4Q	1463044	510	1/4	0.6-14	5.3-124	3.5-10	31.0-88.5	0.92	2.03	8.7	18.4	1/4	10	3/8
C	SD160-LB320-S4Q	1463034	320	1/4	0.6-16	5.3-142	3.5-10	31.0-88.5	0.92	2.03	8.7	18.4	1/4	10	3/8
D	SD023-LR3500-S4Q	1463024	3500	1/4	1.0-2.3	8.9-20.4	1.0-2.3	8.9-20.4	0.76	1.67	8.7	18.4	1/4	10	3/8
D	SD035-LR2200-S4Q	1463014	2200	1/4	1.0-3.5	8.9-31	1.0-3.5	8.9-31	0.76	1.67	8.7	18.4	1/4	10	3/8
D	SD055-LR1470-S4Q	1463004	1470	1/4	0.6-5.5	5.3-48.7	2.0-5.5	17.7-48.7	0.92	2.03	8.7	18.4	1/4	10	3/8
D	SD075-LR1100-S4Q	1462994	1100	1/4	0.6-7.5	5.3-66.4	2.5-7.5	22.1-66.4	0.92	2.03	8.7	18.4	1/4	10	3/8
D	SD100-LR820-S4Q	1462984	820	1/4	0.6-10	5.3-88.5	3.5-10	31.0-88.5	0.92	2.03	8.7	18.4	1/4	10	3/8
D	SD140-LR510-S4Q	1462974	510	1/4	0.6-14	5.3-124	3.5-10	31.0-88.5	0.92	2.03	8.7	18.4	1/4	10	3/8
D	SD160-LR320-S4Q	1462964	320	1/4	0.6-16	5.3-142	3.5-10	31.0-88.5	0.92	2.03	8.7	18.4	1/4	10	3/8

Screwdrivers - Shut off - Pistol grip

0.4 to 16 Nm (3.5 to 142 in.lb) - 180 to 3500 rpm



Model	ØA		L	
	mm (in.)	mm (in.)	mm (in.)	mm (in.)
SBP..	31 (1.22)	182 (7.17)		
SCBP..	31 (1.22)	182 (7.17)		
SCP...	34 (1.34)	228 (8.97)		
SCPT...	34 (1.34)	230 (9.06)		
SDP023..3400	36 (1.42)	194 (7.64)		
SDP035..2100	36 (1.42)	194 (7.64)		
SDP055..1400	36 (1.42)	220 (8.66)		
SDP075..1050	36 (1.42)	220 (8.66)		
SDP100..780	36 (1.42)	220 (8.66)		
SDP140..490	36 (1.42)	220 (8.66)		
SDP160..300	36 (1.42)	220 (8.66)		
SDP045..180	36 (1.42)	220 (8.66)		

Model	L	
	mm (in.)	mm (in.)
SDT023..3500	212 (8.35)	
SDT035..1100	212 (8.35)	
SDT035..2200	212 (8.35)	
SDT055..1470	238 (9.37)	
SDT075..1100	238 (9.37)	
SDT100..800	238 (9.37)	
SDT140..510	238 (9.37)	
SDT160..320	238 (9.37)	

Types D and E, Top air inlet

Accessories: see page 104

PIC REF	MODEL	PART NUMBER	FREE SPEED	OUTPUT HEX	TORQUE RANGE		FITTED SPRING		WEIGHT		AIR FLOW		AIR INLET		HOSE INT. Ø	
			rpm	in.	Nm	in.lb	Nm	in.lb	kg	lb.	l/s	cfm	in.	mm	in.	

PUSH AND TRIGGER START

A	SBP021-T2300-S4Q	1462144	2300	1/4	0.4-2.1	3.5-18.6	0.4-2.1	3.5-18.6	0.82	1.81	6.5	13.8	1/8	6	1/4
A	SBP021-T1600-S4Q	1462154	1600	1/4	0.4-2.1	3.5-18.6	0.4-2.1	3.5-18.6	0.82	1.81	6.5	13.8	1/8	6	1/4
A	SBP043-T1100-S4Q	1462164	1100	1/4	0.4-4.3	3.5-38	1.8-4.3	15.9-38.0	0.82	1.81	6.5	13.8	1/8	6	1/4
A	SBP047-T550-S4Q	1462174	550	1/4	0.4-4.7	3.5-41.6	1.8-4.7	15.9-41.5	0.82	1.81	6.5	13.8	1/8	6	1/4

TRIGGER START

A	SCBP021-T2300-S4Q	1466374	2300	1/4	0.4-2.1	3.5-18.6	0.4-2.1	3.5-18.6	0.82	1.81	6.5	13.8	1/8	6	1/4
A	SCBP021-T1600-S4Q	1466364	1600	1/4	0.4-2.1	3.5-18.6	0.4-2.1	3.5-18.6	0.82	1.81	6.5	13.8	1/8	6	1/4
A	SCBP043-T1100-S4Q	1466354	1100	1/4	0.4-4.3	3.5-38	1.8-4.3	15.9-38	0.82	1.81	6.5	13.8	1/8	6	1/4
A	SCBP044-T740-S4Q	1466344	740	1/4	0.4-4.4	3.5-39	1.8-4.4	15.9-39	0.82	1.81	6.5	13.8	1/8	6	1/4
A	SCBP047-T550-S4Q	1466334	550	1/4	0.4-4.7	3.5-41.6	1.8-4.7	15.9-41.6	0.82	1.81	6.5	13.8	1/8	6	1/4
B	SCP021-T2300-S4Q	1456734	2300	1/4	0.4-2.1	3.5-18.6	0.4-0.9	3.5-7.9	0.86	1.89	6.5	13.8	1/8	6	1/4
B	SCP021-T1600-S4Q	1456744	1600	1/4	0.4-2.1	3.5-18.6	0.6-2.1	5.3-18.6	0.86	1.89	6.5	13.8	1/8	6	1/4
B	SCP043-T1100-S4Q	1456754	1100	1/4	0.4-4.3	3.5-38	0.9-4.3	7.9-38	0.86	1.89	6.5	13.8	1/8	6	1/4
B	SCP047-T550-S4Q	1456764	550	1/4	0.4-4.7	3.5-41.6	0.9-4.7	7.9-41.6	0.86	1.89	6.5	13.8	1/8	6	1/4
C	SDP023-T3400-S4Q	1465784	3400	1/4	1.0-2.3	8.9-20.3	1.0-2.3	8.9-20.3	0.9	1.98	9.0	19.1	1/4	10	3/8
C	SDP035-T2100-S4Q	1465564	2100	1/4	1.0-3.5	8.9-31	1.0-3.5	8.9-31	0.9	1.98	9.0	19.1	1/4	10	3/8
C	SDP055-T1400-S4Q	1465554	1400	1/4	1.0-5.5	8.9-48.7	1.0-5.5	8.9-48.7	1.0	2.20	9.0	19.1	1/4	10	3/8
C	SDP075-T1050-S4Q	1465544	1050	1/4	0.6-7.5	5.3-66.4	2.5-7.5	22.1-66.4	1.0	2.20	9.0	19.1	1/4	10	3/8
C	SDP100-T780-S4Q	1465534	780	1/4	0.6-10	5.3-88.5	3.5-10	31.0-88.5	1.0	2.20	9.0	19.1	1/4	10	3/8
C	SDP140-T490-S4Q	1465524	490	1/4	0.6-14	5.3-124	3.5-10	31.0-88.5	1.0	2.20	9.0	19.1	1/4	10	3/8
C	SDP160-T300-S4Q	1465514	300	1/4	0.6-16	5.3-142	3.5-10	31.0-88.5	1.0	2.20	9.0	19.1	1/4	10	3/8
C	SDP045-T180-S4Q	205 146 706 4	180	1/4	1.5-4.5	13.3-39.8	1.5-4.5	13.3-39.8	1.0	2.20	9.0	19.1	1/4	10	3/8
D	SDT023-T3500-S4Q	1465784	3500	1/4	1.0-2.3	8.9-20.3	1.0-2.3	8.9-20.3	1.1	2.42	9.0	19.1	1/4	10	3/8
D	SDT035-T1100-S4Q	205 147 623 4	1100	1/4	1.0-3.5	8.9-31	1.0-3.5	8.9-31	1.0	2.20	9.0	19.1	1/4	10	3/8
D	SDT035-T2200-S4Q	1465774	2200	1/4	1.0-3.5	8.9-31	1.0-3.5	8.9-31	1.1	2.42	9.0	19.1	1/4	10	3/8
D	SDT055-T1470-S4Q	1465764	1470	1/4	2.0-5.5	17.7-48.7	2.0-5.5	17.7-48.7	1.1	2.42	9.0	19.1	1/4	10	3/8
D	SDT075-T1100-S4Q	1465754	1100	1/4	2.5-7.5	22.1-66.4	2.5-7.5	22.1-66.4	1.1	2.42	9.0	19.1	1/4	10	3/8
D	SDT100-T820-S4Q	1465744	820	1/4	3.5-10	31.0-88.5	3.5-10	31.0-88.5	1.1	2.42	9.0	19.1	1/4	10	3/8
D	SDT140-T510-S4Q	1465734	510	1/4	3.5-14	31.0-124	3.5-10	31.0-88.5	1.1	2.42	9.0	19.1	1/4	10	3/8
D	SDT160-T320-S4Q	1465724	320	1/4	3.5-16	31.0-142	3.5-10	31.0-88.5	1.1	2.42	9.0	19.1	1/4	10	3/8

PUSH START, TOP AIR INLET

E	SCPT021-A2300-S4Q	1458974	2300	1/4	0.4-2.1	3.5-18.6	0.4-0.9	3.5-7.9	0.86	1.89	6.5	13.8	1/8	6	1/4
E	SCPT021-A1600-S4Q	1458934	1600	1/4	0.4-2.1	3.5-18.6	0.6-2.1	5.3-18.6	0.86	1.89	6.5	13.8	1/8	6	1/4
E	SCPT043-A1100-S4Q	1458894	1100	1/4	0.4-4.3	3.5-38	0.9-4.3	7.9-38.0	0.86	1.89	6.5	13.8	1/8	6	1/4
E	SCPT047-A550-S4Q	1458854	550	1/4	0.4-4.7	3.5-41.6	0.9-4.7	7.9-41.6	0.86	1.89	6.5	13.8	1/8	6	1/4

Screwdrivers - Shut off HLT

0.4 to 4.7 Nm (3.5 to 41.6 in.lb) - 550 to 1600 rpm



A



B

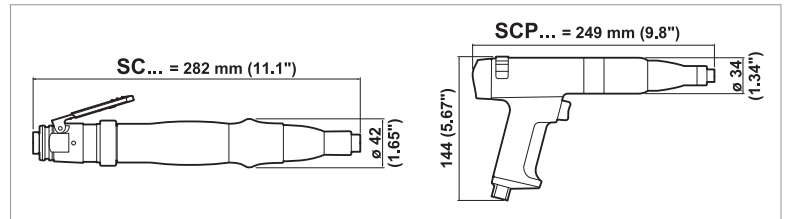

TYPICAL HLT CYCLE

- 1 Tool starts to cut/form thread – direct drive
- 2 Thread is cut/formed, rundown continues – direct drive
- 3 Depth stop touches component, drive engages clutch
- 4 Final torque achieved, clutch operates and air supply is shut off

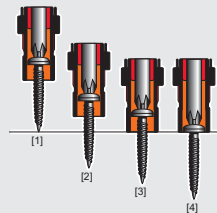

Depth stop changes tool from direct drive to clutch operation

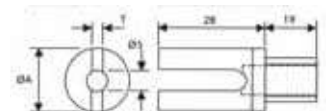
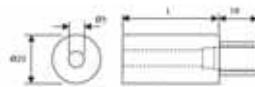
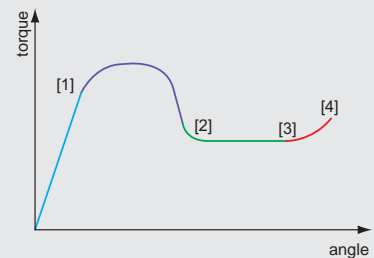

DEPTH STOPS

PIC REF	PART NUMBER	LENGTH
		mm
C	440833	28
C	440843	48
C	440853	127

PIC REF	PART NUMBER	T	ØA
		mm	mm
D	440863*	5	25

* Supplied with tools

Accessories: see page 104

PIC REF	MODEL	PART NUMBER	FREE SPEED	OUTPUT HEX	TORQUE RANGE		FITTED SPRING		WEIGHT		AIR FLOW	AIR INLET	HOSE INT. Ø		
			rpm	in.	Nm	in.lb	Nm	in.lb	kg	lb.	l/s	cfm	in.	mm	in.
A	SC009-L1600-HLT4M	1459644	1600	1/4	0.4-0.9	3.5-7.9	0.4-0.9	3.5-7.9	0.79	1.74	7	15.4	1/8	6	1/4
A	SC021-L1600-HLT4M	1459614	1600	1/4	0.6-2.1	5.3-18.6	0.6-2.1	5.3-18.6	0.79	1.74	7	15.4	1/8	6	1/4
A	SC022-L1100-HLT4M	1459654	1100	1/4	0.6-2.1	5.3-18.6	0.6-2.1	5.3-18.6	0.79	1.74	7	15.4	1/8	6	1/4
A	SC022-L550-HLT4M	1459664	550	1/4	0.6-2.1	5.3-18.6	0.6-2.1	5.3-18.6	0.79	1.74	7	15.4	1/8	6	1/4
A	SC043-L1100-HLT4M	1459624	1100	1/4	0.9-4.3	7.9-38.0	0.9-4.3	7.9-38.0	0.79	1.74	7	15.4	1/8	6	1/4
A	SC047-L550-HLT4M	1459634	550	1/4	0.9-4.7	7.9-41.6	0.9-4.7	7.9-41.6	0.79	1.74	7	15.4	1/8	6	1/4
B	SCP009-T1600-HLT4M	1459704	1600	1/4	0.4-0.9	3.5-7.9	0.4-0.9	3.5-7.9	1.00	2.20	7	15.4	1/8	6	1/4
B	SCP021-T1600-HLT4M	1459714	1600	1/4	0.6-2.1	5.3-18.6	0.6-2.1	5.3-18.6	1.00	2.20	7	15.4	1/8	6	1/4
B	SCP022-T1100-HLT4M	1459724	1100	1/4	0.6-2.1	5.3-18.6	0.6-2.1	5.3-18.6	1.00	2.20	7	15.4	1/8	6	1/4
B	SCP043-T1100-HLT4M	1459734	1100	1/4	0.9-4.3	7.9-38.0	0.9-4.3	7.9-38.0	1.00	2.20	7	15.4	1/8	6	1/4
B	SCP047-T550-HLT4M	1459754	550	1/4	0.9-4.7	7.9-41.6	0.9-4.7	7.9-41.6	1.00	2.20	7	15.4	1/8	6	1/4

FAS3000 - Fastening Assurance System

The FAS3000 – Fastening Assurance System provides the ability to verify that all the fasteners in an assembly have been correctly fastened without the level of investment usually associated with assembly control systems and additional inspection

Features

- Automatic and quick calibration
- 8 programs for different fastener profiles
- Up to 250 fasteners per program
- OK and Not OK visual indicators for each fastener
- Audible error warning for Not OK
- 'Group Cycle Complete' visual indicator
- Manual lockable reset switch
- Password protection of parameters
- 4 output sockets for interfacing with other equipment including inputs as well as output signals
- EMC approved

Coded error messages

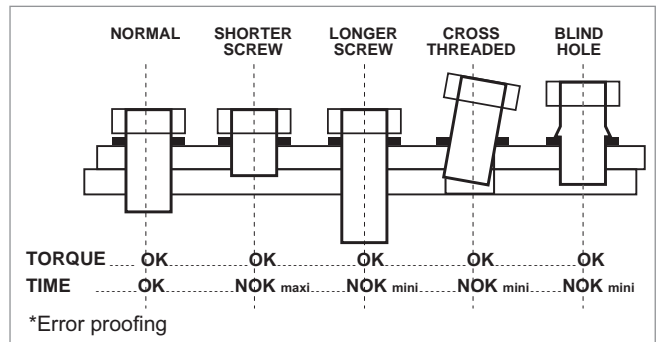

START-UP KIT

to be ordered with the FAS3000

PART NO.

POWER CABLE AND PLUG

LENGTH

ITEM	LENGTH	PART NO.
A Power Cable European	2m (6.56ft)	615 917 201 0
B Power Cable USA	2m (6.56ft)	615 917 203 0
C Power Cable English	2m (6.56ft)	615 917 202 0

ACCESSORIES INCLUDED

ITEM	LENGTH	PART NO.
D Sensor Assembly	2m (6.56ft)	205 047 908 3
E Sensor electric cord	5m (16.4ft)	205 047 964 3

OPTIONAL ACCESSORIES

ITEM	PART NO.
1 Male Stud Elbow M5-D4	615 746 083 0
2 Male Stud M5-D4	615 746 144 0
3 Tube connector D4-D4	615 746 145 0
• M5 Straight Fitting	444973
• M5 Elbow Fitting	444983

MODEL	PART NUMBER	LENGTH		DIMENSIONS WIDTH		HEIGHT		WEIGHT		SUPPLY VOLTAGE
		mm	in.	mm	in.	mm	in.	kg	lb.	
FAS3000	205 146 677 4	317	12.5	161	6.4	87	3.4	3	6.6	AC220-240V, 50Hz & AC110-120V, 60Hz

By comparing the timing of pneumatic signals from a shut off screwdriver with set parameters, the fastening cycle can be monitored and output signals generated for OK and NOK

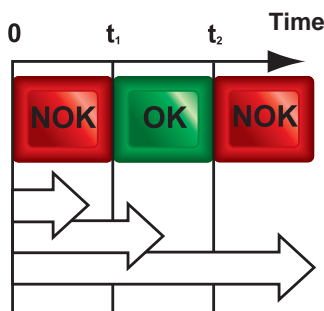

OPERATING SEQUENCE

t_1 = Minimum time

t_2 = Maximum time

Clutch operated before minimum time, lever/trigger released before minimum time

Indicates crossed thread, screw too short, thread too short, too many washers
Clutch operated within time limits - OK

Clutch operated after maximum time Screw too long, no thread in component, stripped thread, no washers on assembly

Screwdrivers - Fastening Assurance System

0.4 to 27 Nm (3.5 to 239 in.lb) - 320 to 3500 rpm



For using D and E tools with FAS3000, order FAS control top devices:
 FAS Control Top Rotary Reverse P.N. **465093**
 FAS Control Top Button Reverse P.N. **465043**

PIC REF	MODEL	PART NUMBER	FREE SPEED	OUTPUT HEX	TORQUE RANGE		FITTED SPRING		WEIGHT		AIR FLOW		AIR INLET		HOSE INT. Ø	
					rpm	in.	Nm	in.lb	Nm	in.lb	kg	lb.	l/s	cfm	in.	mm
PISTOL GRIP																
A	SCP021-T2300-FAS4Q	1461124	2300	1/4	0.4-2.1	3.5-18.6	0.4-0.9	3.5-7.9	0.93	2.0	6.0	12.6	1/8	6	1/4	
A	SCP021-T1600-FAS4Q	1461134	1600	1/4	0.4-2.1	3.5-18.6	0.6-2.1	5.3-18.6	0.93	2.0	6.0	12.6	1/8	6	1/4	
A	SCP043-T1100-FAS4Q	1461144	1100	1/4	0.4-4.3	3.5-38	0.9-4.3	7.9-38	0.93	2.0	6.0	12.6	1/8	6	1/4	
A	SCP047-T550-FAS4Q	1461154	550	1/4	0.4-4.7	3.5-41.6	0.9-4.7	7.9-41.6	0.93	2.0	6.0	12.6	1/8	6	1/4	
T SHAPE TOOLS																
B	SDT023-T3500-S4Q	1465784	3500	1/4	1.0-2.3	8.9-20.4	1.0-2.3	8.9-20.3	1.10	2.4	9.0	19.1	1/4	10	3/8	
B	SDT035-T1100-S4Q	205 147 623 4	1100	1/4	1.0-3.5	8.9-31	1.0-3.5	8.9-31	1.00	2.2	9.0	19.1	1/4	10	3/8	
B	SDT035-T2200-S4Q	1465774	2200	1/4	1.0-3.5	8.9-31	1.0-3.5	8.9-31	1.10	2.4	9.0	19.1	1/4	10	3/8	
B	SDT055-T1470-S4Q	1465764	1470	1/4	2.0-5.5	17.7-48.7	2.0-5.5	17.7-48.7	1.10	2.4	9.0	19.1	1/4	10	3/8	
B	SDT075-T1100-S4Q	1465754	1100	1/4	2.5-7.5	22.1-66.4	2.5-7.5	22.1-66.4	1.10	2.4	9.0	19.1	1/4	10	3/8	
B	SDT100-T800-S4Q	1465744	820	1/4	3.5-10	31.0-88.5	3.5-10	31.0-88.5	1.10	2.4	9.0	19.1	1/4	10	3/8	
B	SDT140-T510-S4Q	1465734	510	1/4	3.5-14	31.0-124	3.5-10	31.0-88.5	1.10	2.4	9.0	19.1	1/4	10	3/8	
B	SDT160-T320-S4Q	1465724	320	1/4	3.5-16	31.0-142	3.5-10	31.0-88.5	1.10	2.4	9.0	19.1	1/4	10	3/8	
IN-LINE TOOLS																
C	SC2-025-L2200-S4Q	205 147 283 4	2200	1/4	0.5-2.5	4.4-22	0.5-2.5	4.4-22.1	0.69	1.5	7.0	14.8	1/4	6	1/4	
C	SC2-035-L1500-S4Q	205 147 282 4	1450	1/4	0.5-3.5	4.4-30.8	1.7-3.5	15-30.9	0.69	1.5	7.0	14.8	1/4	6	1/4	
C	SC2-045-L1000-S4Q	205 147 281 4	1000	1/4	0.5-4.5	4.4-39.6	1.7-4.5	15-39.8	0.69	1.5	7.0	14.8	1/4	6	1/4	
C	SC2-055-L700-S4Q	205 147 280 4	700	1/4	0.5-5.5	4.4-48.4	3-5.5	26.5-48.6	0.69	1.5	7.0	14.8	1/4	6	1/4	
C	SC2-065-L500-S4Q	205 147 279 4	480	1/4	0.5-6.5	4.4-57.2	3-6.5	26.5-57.5	0.69	1.5	7.0	14.8	1/4	6	1/4	
D	SD023-LB3500-S4Q	1463094	3500	1/4	1-2.3	8.9-20.4	1-2.3	8.9-20.4	0.76	1.7	8.7	18.4	1/4	10	3/8	
D	SD035-LB2200-S4Q	1463084	2200	1/4	1-3.5	8.9-31	1-3.5	8.9-31	0.76	1.7	8.7	18.4	1/4	10	3/8	
D	SD055-LB1470-S4Q	1463074	1470	1/4	0.6-5.5	5.3-48.7	2-5.5	17.7-48.7	0.92	2.0	8.7	18.4	1/4	10	3/8	
D	SD075-LB1100-S4Q	1463064	1100	1/4	0.6-7.5	5.3-66.4	2.5-7.5	22.1-66.4	0.92	2.0	8.7	18.4	1/4	10	3/8	
D	SD100-LB820-S4Q	1463054	820	1/4	0.6-10	5.3-88.5	3.5-10	31-88.5	0.92	2.0	8.7	18.4	1/4	10	3/8	
D	SD140-LB510-S4Q	1463044	510	1/4	0.6-14	5.3-124	3.5-10	31-88.5	0.92	2.0	8.7	18.4	1/4	10	3/8	
D	SD160-LB320-S4Q	1463034	320	1/4	0.6-16	5.3-142	3.5-10	31-88.5	0.92	2.0	8.7	18.4	1/4	10	3/8	
D	SD023-LR3500-S4Q	1463024	3500	1/4	1-2.3	8.9-20.4	1-2.3	8.9-20.4	0.76	1.7	8.7	18.4	1/4	10	3/8	
D	SD035-LR2200-S4Q	1463014	2200	1/4	1-3.5	8.9-31	1-3.5	8.9-31	0.76	1.7	8.7	18.4	1/4	10	3/8	
D	SD055-LR1470-S4Q	1463004	1470	1/4	0.6-5.5	5.3-48.7	2-5.5	17.7-48.7	0.92	2.0	8.7	18.4	1/4	10	3/8	
D	SD075-LR1100-S4Q	1462994	1100	1/4	0.6-7.5	5.3-66.4	2.5-7.5	22.1-66.4	0.92	2.0	8.7	18.4	1/4	10	3/8	
D	SD100-LR820-S4Q	1462984	820	1/4	0.6-10	5.3-88.5	3.5-10	31-88.5	0.92	2.0	8.7	18.4	1/4	10	3/8	
D	SD140-LR510-S4Q	1462974	510	1/4	0.6-14	5.3-124	3.5-10	31-88.5	0.92	2.0	8.7	18.4	1/4	10	3/8	
D	SD160-LR320-S4Q	1462964	320	1/4	0.6-16	5.3-142	3.5-10	31-88.5	0.92	2.0	8.7	18.4	1/4	10	3/8	
ANGLE TOOLS																
E	SD070-LB1100-S90-A4H	1463254	1100	1/4	2.5-7	22.1-61.9	2.5-7	22.1-61.9	1.12	2.5	8.7	18.4	1/4	10	3/8	
E	SD070-LB820-S90-A4H	1463244	820	1/4	2.5-7	22.1-61.9	2.5-7	22.1-61.9	1.12	2.5	8.7	18.4	1/4	10	3/8	
E	SD070-LB510-S90-A4H	1463234	510	1/4	2.5-7	22.1-61.9	2.5-7	22.1-61.9	1.12	2.5	8.7	18.4	1/4	10	3/8	
E	SD070-LB320-S90-A4H	1463224	320	1/4	2.5-7	22.1-61.9	2.5-7	22.1-61.9	1.12	2.5	8.7	18.4	1/4	10	3/8	
E	SD070-LR1100-S90-A4H	1463294	1100	1/4	2.5-7	22.1-61.9	2.5-7	22.1-61.9	1.12	2.5	8.7	18.4	1/4	10	3/8	
E	SD070-LR820-S90-A4H	1463284	820	1/4	2.5-7	22.1-61.9	2.5-7	22.1-61.9	1.12	2.5	8.7	18.4	1/4	10	3/8	
E	SD070-LR510-S90-A4H	1463274	510	1/4	2.5-7	22.1-61.9	2.5-7	22.1-61.9	1.12	2.5	8.7	18.4	1/4	10	3/8	
E	SD070-LR320-S90-A4H	1463264	320	1/4	2.5-7	22.1-61.9	2.5-7	22.1-61.9	1.12	2.5	8.7	18.4	1/4	10	3/8	
E	SD070-LB1100-S90-A4S	1463374	1100	1/4 sq	2.5-7	22.1-61.9	2.5-7	22.1-61.9	1.11	2.4	8.7	18.4	1/4	10	3/8	
E	SD070-LB820-S90-A4S	1463364	820	1/4 sq	2.5-7	22.1-61.9	2.5-7	22.1-61.9	1.11	2.4	8.7	18.4	1/4	10	3/8	
E	SD070-LB510-S90-A4S	1463354	510	1/4 sq	2.5-7	22.1-61.9	2.5-7	22.1-61.9	1.11	2.4	8.7	18.4	1/4	10	3/8	
E	SD070-LB320-S90-A4S	1463344	320	1/4 sq	2.5-7	22.1-61.9	2.5-7	22.1-61.9	1.11	2.4	8.7	18.4	1/4	10	3/8	
E	SD070-LR1100-S90-A4S	1463414	1100	1/4 sq	2.5-7	22.1-61.9	2.5-7	22.1-61.9	1.11	2.4	8.7	18.4	1/4	10	3/8	
E	SD070-LR820-S90-A4S	1463404	820	1/4 sq	2.5-7	22.1-61.9	2.5-7	22.1-61.9	1.11	2.4	8.7	18.4	1/4	10	3/8	
E	SD070-LR510-S90-A4S	1463394	510	1/4 sq	2.5-7	22.1-61.9	2.5-7	22.1-61.9	1.11	2.4	8.7	18.4	1/4	10	3/8	
E	SD070-LR320-S90-A4S	1463384	320	1/4 sq	2.5-7	22.1-61.9	2.5-7	22.1-61.9	1.11	2.4	8.7	18.4	1/4	10	3/8	
E	SD072-LB1080-S90-A10S1463504	1080	3/8 sq	2.5-7.2	22.1-63.7	2.5-7.2	22.1-63.7	1.41	3.1	8.7	18.4	1/4	10	3/8		
E	SD095-LB800-S90-A10S	1463494	800	3/8 sq	3-9.5	26.5-84.0	3-9.5	26.5-84	1.41	3.1	8.7	18.4	1/4	10	3/8	
E	SD130-LB600-S90-A10S	1463484	600	3/8 sq	4.5-12	39.8-106	4.5-12	39.8-106	1.41	3.1	8.7	18.4	1/4	10	3/8	
E	SD209-LB370-S90-A10S	1463474	370	3/8 sq	6-19	53.1-168	6-19	53.1-168	1.50	3.3	8.7	18.4	1/4	10	3/8	
E	SD300-LB250-S90-A10S	1463464	250	3/8 sq	11-27	97.3-239	11-27	97.3-239	1.50	3.3	8.7	18.4	1/4	10	3/8	
E	SD072-LR1080-S90-A10S1463554	1080	3/8 sq	2.5-7.2	22.1-63.7	2.5-7.2	22.1-63.7	1.41	3.1	8.7	18.4	1/4	10	3/8		
E	SD095-LR800-S90-A10S	1463544	800	3/8 sq	3-9.5	26.5-84	3-9.5	26.5-84	1.41	3.1	8.7	18.4	1/4	10	3/8	
E	SD130-LR600-S90-A10S	1463534	600	3/8 sq	4.5-12	39.8-106	4.5-12	39.8-106	1.41	3.1	8.7	18.4	1/4	10	3/8	
E	SD209-LR370-S90-A10S	1463524	370	3/8 sq	6-19	53.1-168	6-19	53.1-168	1.50	3.3	8.7	18.4	1/4	10	3/8	
E	SD300-LR250-S90-A10S	1463514	250	3/8 sq	11-27	97.3-239	11-27	97.3-239	1.50	3.3	8.7	18.4	1/4	10	3/8	

Screwdrivers - Non Shut off - Push and Lever start

0.4 to 10 Nm (3.5 to 88.5 in.lb) - 510 to 3500 rpm

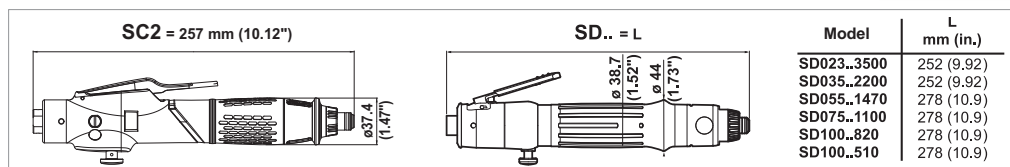

Types A, B and F - 5/16" hex bit holder optional

Accessories: see page 104

PIC REF	MODEL	PART NUMBER	FREE SPEED	OUTPUT HEX	TORQUE RANGE		FITTED SPRING		WEIGHT		AIR FLOW		AIR INLET		HOSE INT. Ø	
					Nm	in.lb	Nm	in.lb	kg	lb.	l/s	cfm	in.	mm	in.	

PUSH START

A	SC2-025-A2200-R4Q	205 147 276 4	2200	1/4	0.5-2.5	4.4-22.0	0.5-2.5	4.4-22.1	0.69	1.52	7.0	14.8	1/4	6	1/4
A	SC2-035-A1500-R4Q	205 147 275 4	1450	1/4	0.5-3.5	4.4-30.8	1.7-3.5	15.0-30.9	0.69	1.52	7.0	14.8	1/4	6	1/4
A	SC2-045-A1000-R4Q	205 147 274 4	1000	1/4	0.5-4.5	4.4-39.6	1.7-4.5	15.0-39.8	0.69	1.52	7.0	14.8	1/4	6	1/4
A	SC2-055-A700-R4Q	205 147 273 4	700	1/4	0.5-5.5	4.4-48.4	3.0-5.5	26.5-48.6	0.69	1.52	7.0	14.8	1/4	6	1/4
A	SC2-065-A500-R4Q	205 147 272 4	480	1/4	0.5-6.5	4.4-57.2	3.0-6.5	26.5-57.5	0.69	1.52	7.0	14.8	1/4	6	1/4
B	SD023-AB3500-R4Q	1462954	3500	1/4	1.0-2.3	8.9-20.3	1.0-2.3	8.9-20.3	0.73	1.61	8.7	18.4	1/4	10	3/8
B	SD035-AB2200-R4Q	1462944	2200	1/4	1.0-3.5	8.9-31.0	1.0-3.5	8.9-31.0	0.73	1.61	8.7	18.4	1/4	10	3/8
B	SD055-AB1470-R4Q	1462934	1470	1/4	0.6-5.5	5.3-48.7	2.0-5.5	17.7-48.7	0.89	1.96	8.7	18.4	1/4	10	3/8
B	SD075-AB1100-R4Q	1462924	1100	1/4	0.6-7.5	5.3-66.4	2.5-7.5	22.1-66.4	0.89	1.96	8.7	18.4	1/4	10	3/8
B	SD100-AB820-R4Q	1462914	820	1/4	0.6-10	5.3-88.5	3.5-10	31.0-88.5	0.89	1.96	8.7	18.4	1/4	10	3/8
B	SD100-AB510-R4Q	1462904	510	1/4	0.6-10	5.3-88.5	3.5-10	31.0-88.5	0.89	1.96	8.7	18.4	1/4	10	3/8
C	SD023-AR3500-R4Q	1462894	3500	1/4	1.0-2.3	8.9-20.3	1.0-2.3	8.9-20.3	0.73	1.61	8.7	18.4	1/4	10	3/8
C	SD035-AR2200-R4Q	1462884	2200	1/4	1.0-3.5	8.9-31.0	1.0-3.5	8.9-31.0	0.73	1.61	8.7	18.4	1/4	10	3/8
C	SD055-AR1470-R4Q	1462874	1470	1/4	0.6-5.5	5.3-48.7	2.0-5.5	17.7-48.7	0.89	1.96	8.7	18.4	1/4	10	3/8
C	SD075-AR1100-R4Q	1462864	1100	1/4	0.6-7.5	5.3-66.4	2.5-7.5	22.1-66.4	0.89	1.96	8.7	18.4	1/4	10	3/8
C	SD100-AR820-R4Q	1462854	820	1/4	0.6-10	5.3-88.5	3.5-10	31.0-88.5	0.89	1.96	8.7	18.4	1/4	10	3/8
C	SD100-AR510-R4Q	1462844	510	1/4	0.6-10	5.3-88.5	3.5-10	31.0-88.5	0.89	1.96	8.7	18.4	1/4	10	3/8

LEVER START

D	SC2-025-L2200-R4Q	205 147 290 4	2200	1/4	0.5-2.5	4.4-22.0	0.5-2.5	4.4-22.1	0.69	1.52	7.0	14.8	1/4	6	1/4
D	SC2-035-L1500-R4Q	205 147 289 4	1450	1/4	0.5-3.5	4.4-30.8	1.7-3.5	15.0-30.9	0.69	1.52	7.0	14.8	1/4	6	1/4
D	SC2-045-L1000-R4Q	205 147 288 4	1000	1/4	0.5-4.5	4.4-39.6	1.7-4.5	15.0-39.8	0.69	1.52	7.0	14.8	1/4	6	1/4
D	SC2-055-L700-R4Q	205 147 287 4	700	1/4	0.5-5.5	4.4-48.4	3.0-5.5	26.5-48.6	0.69	1.52	7.0	14.8	1/4	6	1/4
D	SC2-065-L500-R4Q	205 147 286 4	480	1/4	0.5-6.5	4.4-57.2	3.0-6.5	26.5-57.5	0.69	1.52	7.0	14.8	1/4	6	1/4
E	SD023-LB3500-R4Q	1463214	3500	1/4	1.0-2.3	8.9-20.3	1.0-2.3	8.9-20.3	0.76	1.67	8.7	18.4	1/4	10	3/8
E	SD035-LB2200-R4Q	1463204	2200	1/4	1.0-3.5	8.9-31.0	1.0-3.5	8.9-31.0	0.76	1.67	8.7	18.4	1/4	10	3/8
E	SD055-LB1470-R4Q	1463194	1470	1/4	0.6-5.5	5.3-48.7	2.0-5.5	17.7-48.7	0.92	2.03	8.7	18.4	1/4	10	3/8
E	SD075-LB1100-R4Q	1463184	1100	1/4	0.6-7.5	5.3-66.4	2.5-7.5	22.1-66.4	0.92	2.03	8.7	18.4	1/4	10	3/8
E	SD100-LB820-R4Q	1463174	820	1/4	0.6-10	5.3-88.5	3.5-10	31.0-88.5	0.92	2.03	8.7	18.4	1/4	10	3/8
E	SD100-LB510-R4Q	1463164	510	1/4	0.6-10	5.3-88.5	3.5-10	31.0-88.5	0.92	2.03	8.7	18.4	1/4	10	3/8
F	SD023-LR3500-R4Q	1463154	3500	1/4	1.0-2.3	8.9-20.3	1.0-2.3	8.9-20.3	0.76	1.67	8.7	18.4	1/4	10	3/8
F	SD035-LR2200-R4Q	1463144	2200	1/4	1.0-3.5	8.9-31.0	1.0-3.5	8.9-31.0	0.76	1.67	8.7	18.4	1/4	10	3/8
F	SD055-LR1470-R4Q	1463134	1470	1/4	0.6-5.5	5.3-48.7	2.0-5.5	17.7-48.7	0.92	2.03	8.7	18.4	1/4	10	3/8
F	SD075-LR1100-R4Q	1463124	1100	1/4	0.6-7.5	5.3-66.4	2.5-7.5	22.1-66.4	0.92	2.03	8.7	18.4	1/4	10	3/8
F	SD100-LR820-R4Q	1463114	820	1/4	0.6-10	5.3-88.5	3.5-10	31.0-88.5	0.92	2.03	8.7	18.4	1/4	10	3/8
F	SD100-LR510-R4Q	1463104	510	1/4	0.6-10	5.3-88.5	3.5-10	31.0-88.5	0.92	2.03	8.7	18.4	1/4	10	3/8

Screwdrivers - Non Shut Off - Pistol Grip

0.4 to 10 Nm (3.5 to 88.5 in.lb) - 300 to 3500 rpm

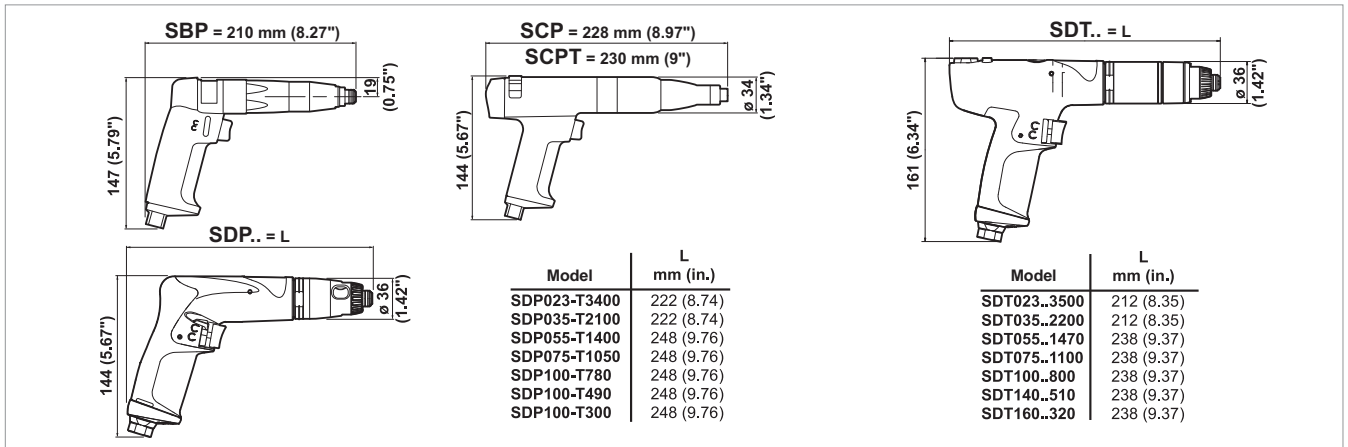

Accessories: see page 104

PIC REF	MODEL	PART NUMBER	FREE SPEED	OUTPUT HEX	TORQUE RANGE		FITTED SPRING		WEIGHT		AIR FLOW		AIR INLET		HOSE INT. Ø	
					Nm	in.lb	Nm	in.lb	kg	lb.	l/s	cfm	in.	mm	in.	
PUSH AND TRIGGER START																
A	SBP024-T2300-R4Q	1462184	2300	1/4	0.5-2.4	4.4-21.2	0.5-2.4	4.4-21.2	0.82	1.81	6.5	13.8	1/8	6	1/4	
A	SBP022-T1600-R4Q	1462194	1600	1/4	0.5-2.2	4.4-19.4	0.5-2.2	4.4-19.4	0.82	1.81	6.5	13.8	1/8	6	1/4	
A	SBP044-T1100-R4Q	1462204	1100	1/4	0.4-4.4	3.5-38.9	1.8-4.4	15.9-38.9	0.82	1.81	6.5	13.8	1/8	6	1/4	
A	SBP044-T550-R4Q	1462214	550	1/4	0.4-4.4	3.5-38.9	1.8-4.4	15.9-38.9	0.82	1.81	6.5	13.8	1/8	6	1/4	
TRIGGER START																
B	SCP024-T2300-R4Q	1456774	2300	1/4	0.5-2.4	4.4-21.2	0.5-1.8	4.4-15.9	0.86	1.89	6.5	13.8	1/8	6	1/4	
B	SCP022-T1600-R4Q	1456784	1600	1/4	0.5-2.2	4.4-19.4	0.8-2.2	7.1-19.4	0.86	1.89	6.5	13.8	1/8	6	1/4	
B	SCP044-T1100-R4Q	1456794	1100	1/4	0.4-4.4	3.5-38.9	1.3-4.4	11.5-38.9	0.86	1.89	6.5	13.8	1/8	6	1/4	
B	SCP044-T550-R4Q	1456804	550	1/4	0.4-4.4	3.5-38.9	1.0-4.4	8.9-38.9	0.86	1.89	6.5	13.8	1/8	6	1/4	
C	SDP023-T3400-R4Q	1465644	3400	1/4	1.0-2.3	8.8-20.3	1.0-2.3	8.9-20.3	0.90	1.98	9.0	19.1	1/4	10	3/8	
C	SDP035-T2100-R4Q	1465634	2100	1/4	1.0-3.5	8.8-31.0	1.0-3.5	8.9-31.0	0.90	1.98	9.0	19.1	1/4	10	3/8	
C	SDP055-T1400-R4Q	1465624	1400	1/4	1.0-5.5	8.8-48.6	1.0-5.5	8.9-48.6	1.00	2.20	9.0	19.1	1/4	10	3/8	
C	SDP075-T1050-R4Q	1465614	1050	1/4	0.6-7.5	5.3-66.3	2.5-7.5	22.1-66.3	1.00	2.20	9.0	19.1	1/4	10	3/8	
C	SDP100-T780-R4Q	1465604	780	1/4	0.6-10	5.3-88.5	3.5-10	31.0-88.5	1.00	2.20	9.0	19.1	1/4	10	3/8	
C	SDP100-T490-R4Q	1465594	490	1/4	0.6-10	5.3-88.5	3.5-10	31.0-88.5	1.00	2.20	9.0	19.1	1/4	10	3/8	
C	SDP100-T300-R4Q	1465584	300	1/4	0.6-10	5.3-88.5	3.5-10	31.0-88.5	1.00	2.20	9.0	19.1	1/4	10	3/8	
D	SDT023-T3500-R4Q	205 147 635 4	3500	1/4	1.0-2.3	8.9-20.3	1.0-2.3	8.9-20.3	1.10	2.42	9.0	19.1	1/4	10	3/8	
D	SDT035-T2200-R4Q	205 147 636 4	2200	1/4	1.0-3.5	8.9-31	1.0-3.5	8.9-31.0	1.10	2.42	9.0	19.1	1/4	10	3/8	
D	SDT055-T1470-R4Q	205 147 637 4	1470	1/4	2.0-5.5	17.7-48.7	2.0-5.5	17.7-48.7	1.10	2.42	9.0	19.1	1/4	10	3/8	
D	SDT075-T1100-R4Q	205 147 638 4	1100	1/4	2.5-7.5	22.1-66.4	2.5-7.5	22.1-66.4	1.10	2.42	9.0	19.1	1/4	10	3/8	
D	SDT100-T820-R4Q	205 147 639 4	820	1/4	3.5-10	31.0-88.5	3.5-10	31.0-88.5	1.10	2.42	9.0	19.1	1/4	10	3/8	
D	SDT100-T510-R4Q	205 147 644 4	510	1/4	3.5-10	31.0-88.5	3.5-10	31.0-88.5	1.10	2.42	9.0	19.1	1/4	10	3/8	
D	SDT100-T320-R4Q	205 147 641 4	320	1/4	3.5-10	31.0-88.5	3.5-10	31.0-88.5	1.10	2.42	9.0	19.1	1/4	10	3/8	
PUSH START, TOP AIR INLET																
E	SCPT024-A2300-R4Q	1458994	2300	1/4	0.5-2.4	4.4-21.2	0.5-1.8	4.4-15.9	0.86	1.89	6.5	13.8	1/8	6	1/4	
E	SCPT022-A1600-R4Q	1458954	1600	1/4	0.5-2.2	4.4-19.4	0.8-2.2	7.1-19.4	0.86	1.89	6.5	13.8	1/8	6	1/4	
E	SCPT044-A1100-R4Q	1458914	1100	1/4	0.4-4.4	3.5-38.9	1.3-4.4	11.5-38.9	0.86	1.89	6.5	13.8	1/8	6	1/4	

Screwdrivers - Direct drive Pistol grip

1 to 14 Nm (8.9 to 124 in.lb) - 490 to 3400 rpm



A

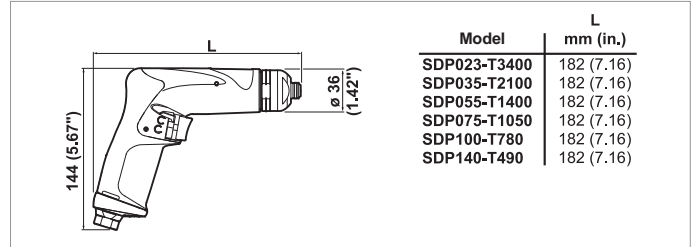

Accessories: see page 105

PIC REF	MODEL	PART NUMBER	FREE SPEED	OUTPUT HEX	TORQUE RANGE		WEIGHT		AIR FLOW		AIR INLET	HOSE INT. Ø	
			rpm	in.	Nm	in.lb	kg	lb.	l/s	cfm	in.	mm	in.
A	SDP023-T3400-D4Q	1465714	3400	1/4	1.0-2.3	8.9-20.3	0.8	1.76	9.0	19.1	1/4	10	3/8
A	SDP035-T2100-D4Q	1465704	2100	1/4	1.0-3.5	8.9-31.0	0.8	1.76	9.0	19.1	1/4	10	3/8
A	SDP055-T1400-D4Q	1465694	1400	1/4	1.0-5.5	8.9-48.6	0.8	1.76	9.0	19.1	1/4	10	3/8
A	SDP075-T1050-D4Q	1465684	1050	1/4	3.5-7.5	31-66.3	0.8	1.76	9.0	19.1	1/4	10	3/8
A	SDP100-T780-D4Q	1465674	780	1/4	3.5-10	31-88.5	0.8	1.76	9.0	19.1	1/4	10	3/8
A	SDP140-T490-D4Q	1465664	490	1/4	3.5-14	31-124	0.8	1.76	9.0	19.1	1/4	10	3/8

Screwdrivers - Left hand tightening - Shut off - Push start Automatic reverse

0.6 to 16 Nm (5.3 to 142 in.lb) - 320 to 1100 rpm



A



B

Tool shown with optional clutch HSG and bit adaptor

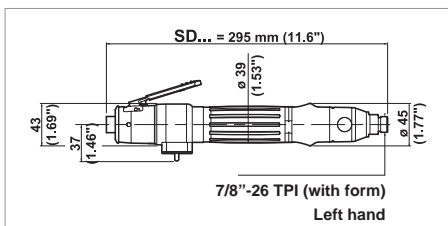
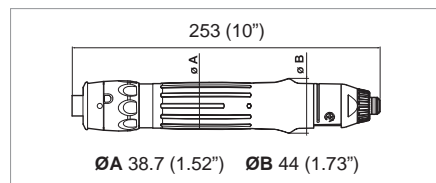

Applications

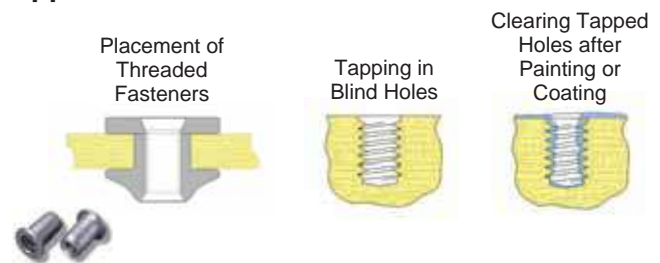

Accessories: see page 104 and 105

PIC REF	MODEL	PART NUMBER	FREE SPEED	OUTPUT HEX	TORQUE RANGE		FITTED SPRING		WEIGHT		AIR FLOW		AIR INLET	HOSE INT. Ø	
			rpm	in.	Nm	in.lb	Nm	in.lb	kg	lb.	l/s	cfm	in.	mm	in.
LEFT HAND TIGHTENING - SHUT OFF - PUSH START															
A	SD160L-AR320-S4Q	205 147 799 4	320	1/4	0.6-16	5.3-142	3.5-10	31-88.5	0.89	1.96	8.7	18.4	1/4	10	3/8
AUTOMATIC REVERSE															
B	SD140-LA510-S4	1464584	510	See	0.6-14	5.3-124			1.0	2.2	8.7	18.4	1/4	10	3/8
B	SD075-LA1100-S4	1464604	1100	Accessories	0.6-7.5	5.3-66.4			1.0	2.2	8.7	18.4	1/4	10	3/8

Screwdrivers - High torque & Torque Controlled

Shut off

9 to 22 Nm (27 to 195 in.lb) - 320 rpm



A



B

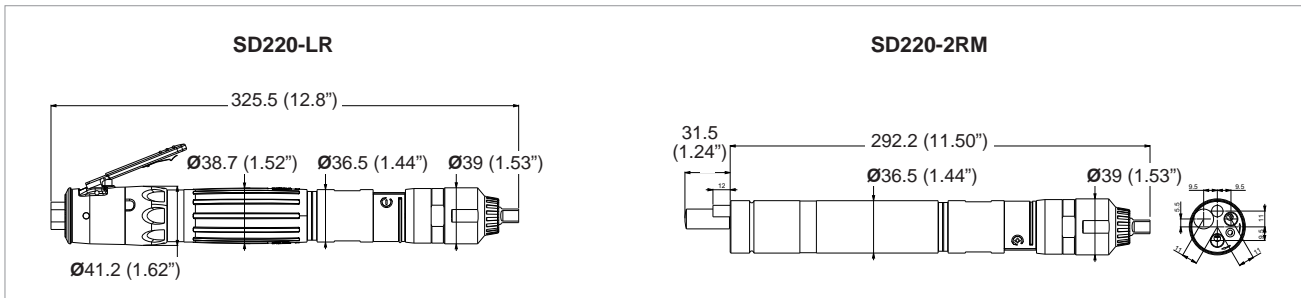

Accessories: see page 104 and 107

PIC REF	MODEL	PART NUMBER	FREE SPEED	OUTPUT DRIVE	TORQUE RANGE				WEIGHT		AIR FLOW		HOSE INT. Ø	
					HARD JOINT	SOFT JOINT	kg	lb	l/s	cfm	mm	in.		
			rpm	in.	Nm	in.lb	Nm	in.lb						
SCREWDRIVERS - LEVER START - SHUT OFF														
A	SD220-LR320-S4Q	205 147 937 4	320	1/4 Hex	9-16	27-142	9-16	27-142	1.4	3.1	8.7	18.4	10	3/8
A	SD220-LR320-S10S	205 147 979 4	320	3/8 Sq	9-22	27-198	9-19	27-168	1.4	3.1	8.7	18.4	10	3/8
AUTOMATION - REMOTE START - SHUT OFF - 2 WAY														
B	SD220-2RM320-S4Q	205 147 939 4	320	1/4 Hex	9-16	27-142	9-16	27-142	1.4	3.1	8.7	18.4	10	3/8
B	SD220-2RM320-S10S	205 147 941 4	320	3/8 Sq	9-22	27-198	9-19	27-168	1.4	3.1	8.7	18.4	10	3/8

* All models: Air inlet 1/4"BSP ** Pistol version and slower speed on request - Please contact your local Desoutter

Angle Head - Shut off

0.4 to 27 Nm (3.5 to 239 in.lb) - 170 to 2200 rpm

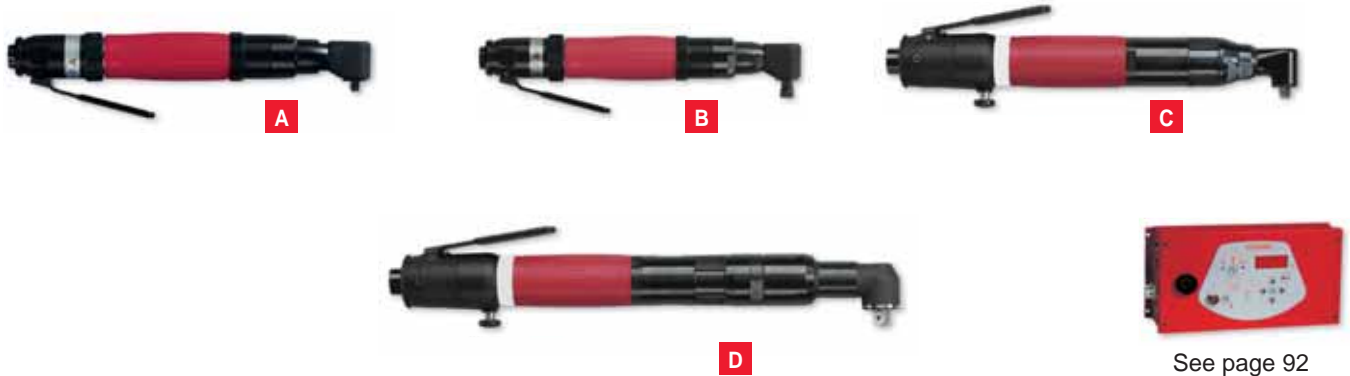

Accessories: see page 106



PIC REF	MODEL	PART NUMBER	FREE SPEED	OUTPUT DRIVE	TORQUE RANGE		FITTED SPRING		LENGTH		WEIGHT		AIR FLOW		AIR INLET	HOSE INT. Ø	
					Nm	in.lb	Nm	in.lb	mm	in.	kg	lb.	l/s	cfm	in.	mm	in.
TWO WAY																	
A	SC021-L2000-S90A4S	1459154	2000	1/4 sq	0.4-2.1	3.5-18.6	0.4-0.9	3.5-7.9	275	10.8	0.84	1.85	6.5	13.8	1/8	6	1/4
A	SC021-L1400-S90A4S	1459144	1400	1/4 sq	0.4-2.1	3.5-18.6	0.6-2.1	5.3-18.6	275	10.8	0.84	1.85	6.5	13.8	1/8	6	1/4
A	SC043-L950-S90A4S	1459134	950	1/4 sq	0.4-4.3	3.5-38	0.9-4.3	7.9-38	275	10.8	0.84	1.85	6.5	13.8	1/8	6	1/4
A	SC047-L500-S90A4S	1459124	500	1/4 sq	0.4-4.7	3.5-41.5	0.9-4.7	7.9-41.5	275	10.8	0.84	1.85	6.5	13.8	1/8	6	1/4
B	SC021-L2000-S90A4H	1459074	2000	1/4 hex	0.4-2.1	3.5-18.6	0.4-0.9	3.5-7.9	275	10.8	1.12	2.47	6.5	13.8	1/8	6	1/4
B	SC021-L1400-S90A4H	1459064	1400	1/4 hex	0.4-2.1	3.5-18.6	0.6-2.1	5.3-18.6	275	10.8	1.12	2.47	6.5	13.8	1/8	6	1/4
B	SC043-L950-S90A4H	1459054	950	1/4 hex	0.4-4.3	3.5-38	0.9-4.3	7.9-38	275	10.8	1.12	2.47	6.5	13.8	1/8	6	1/4
B	SC047-L500-S90A4H	1459044	500	1/4 hex	0.4-4.7	3.5-41.5	0.9-4.7	7.9-41.5	275	10.8	1.12	2.47	6.5	13.8	1/8	6	1/4
C	SD070-LB1100-S90-A4H	1463254	1100	1/4 hex	2.5-7	22-61.9	2.5-7	22-61.9	305	12.0	1.12	2.47	8.7	18.4	1/4	10	3/8
C	SD070-LB820-S90-A4H	1463244	820	1/4 hex	2.5-7	22-61.9	2.5-7	22-61.9	305	12.0	1.12	2.47	8.7	18.4	1/4	10	3/8
C	SD070-LB510-S90-A4H	1463234	510	1/4 hex	2.5-7	22-61.9	2.5-7	22-61.9	305	12.0	1.12	2.47	8.7	18.4	1/4	10	3/8
C	SD070-LB320-S90-A4H	1463224	320	1/4 hex	2.5-7	22-61.9	2.5-7	22-61.9	305	12.0	1.12	2.47	8.7	18.4	1/4	10	3/8
C	SD070-LR1100-S90-A4H	1463294	1100	1/4 hex	2.5-7	22-61.9	2.5-7	22-61.9	305	12.0	1.11	2.45	8.7	18.4	1/4	10	3/8
C	SD070-LR820-S90-A4H	1463284	820	1/4 hex	2.5-7	22-61.9	2.5-7	22-61.9	305	12.0	1.11	2.45	8.7	18.4	1/4	10	3/8
C	SD070-LR510-S90-A4H	1463274	510	1/4 hex	2.5-7	22-61.9	2.5-7	22-61.9	305	12.0	1.11	2.45	8.7	18.4	1/4	10	3/8
C	SD070-LR320-S90-A4H	1463264	320	1/4 hex	2.5-7	22-61.9	2.5-7	22-61.9	305	12.0	1.11	2.45	8.7	18.4	1/4	10	3/8
C	SD070-LB1100-S90-A4S	1463374	1100	1/4 sq	2.5-7	22-61.9	2.5-7	22-61.9	305	12.0	1.11	2.45	8.7	18.4	1/4	10	3/8
C	SD070-LB820-S90-A4S	1463364	820	1/4 sq	2.5-7	22-61.9	2.5-7	22-61.9	305	12.0	1.11	2.45	8.7	18.4	1/4	10	3/8
C	SD070-LB510-S90-A4S	1463354	510	1/4 sq	2.5-7	22-61.9	2.5-7	22-61.9	305	12.0	1.11	2.45	8.7	18.4	1/4	10	3/8
C	SD070-LB320-S90-A4S	1463344	320	1/4 sq	2.5-7	22-61.9	2.5-7	22-61.9	305	12.0	1.11	2.45	8.7	18.4	1/4	10	3/8
C	SD070-LR1100-S90-A4S	1463414	1100	1/4 sq	2.5-7	22-61.9	2.5-7	22-61.9	305	12.0	1.11	2.45	8.7	18.4	1/4	10	3/8
C	SD070-LR820-S90-A4S	1463404	820	1/4 sq	2.5-7	22-61.9	2.5-7	22-61.9	305	12.0	1.11	2.45	8.7	18.4	1/4	10	3/8
C	SD070-LR510-S90-A4S	1463394	510	1/4 sq	2.5-7	22-61.9	2.5-7	22-61.9	305	12.0	1.11	2.45	8.7	18.4	1/4	10	3/8
C	SD070-LR320-S90-A4S	1463384	320	1/4 sq	2.5-7	22-61.9	2.5-7	22-61.9	305	12.0	1.11	2.45	8.7	18.4	1/4	10	3/8
C	SD070-LR170-S90-A4S	205 146 705 4	170	1/4 sq	2.5-7	22-61.9	2.5-7	22-61.9	306	12.0	1.11	2.45	8.7	18.4	1/4	10	3/8
C	SD072-LB1080-S90-A10S	1463504	1080	3/8 sq	2.5-7.2	22-63.7	2.5-7.2	22-63.7	353	13.9	1.41	3.11	8.7	18.4	1/4	10	3/8
D	SD095-LB800-S90-A10S	1463494	800	3/8 sq	3-9.5	26.6-84.1	3-9.5	26.6-84.1	353	13.9	1.41	3.11	8.7	18.4	1/4	10	3/8
D	SD130-LB600-S90-A10S	1463484	600	3/8 sq	4.5-12	39.8-106	4.5-12	39.8-106	353	13.9	1.41	3.11	8.7	18.4	1/4	10	3/8
D	SD209-LB370-S90-A10S	1463474	370	3/8 sq	6-19	53.1-168	6-19	53.1-168	376	14.8	1.50	3.31	8.7	18.4	1/4	10	3/8
D	SD300-LB250-S90-A10S	1463464	250	3/8 sq	11-27	97.3-239	11-27	97.3-239	376	14.8	1.50	3.31	8.7	18.4	1/4	10	3/8
D	SD072-LR1080-S90-A10S	1463554	1080	3/8 sq	2.5-7.2	22-63.7	2.5-7.2	22-63.7	376	14.8	1.41	3.11	8.7	18.4	1/4	10	3/8
D	SD095-LR800-S90-A10S	1463544	800	3/8 sq	3-9.5	26.6-84.1	3-9.5	26.6-84.1	376	14.8	1.41	3.11	8.7	18.4	1/4	10	3/8
D	SD130-LR600-S90-A10S	1463534	600	3/8 sq	4.5-12	39.8-106	4.5-12	39.8-106	376	14.8	1.41	3.11	8.7	18.4	1/4	10	3/8
D	SD209-LR370-S90-A10S	1463524	370	3/8 sq	6-19	53.1-168	6-19	53.1-168	376	14.8	1.41	3.11	8.7	18.4	1/4	10	3/8
D	SD300-LR250-S90-A10S	1463514	250	3/8 sq	11-27	97.3-239	11-27	97.3-239	376	14.8	1.50	3.31	8.7	18.4	1/4	10	3/8
D	SD300-LR180-S90-A10S	205 146 704 4	180	3/8 sq	11-27	97.3-239	11-27	97.3-239	375	14.8	1.50	3.30	8.7	18.4	1/4	10	3/8

SH range - Angle head - Shut off

2.5 to 200 Nm (22.1 to 1770 in.lb) - 80 to 1100 rpm



Option:

Reaction bar for SH850/1200/2000



FAS3000 (optional): PLC External control
OK / NOK reporting Batch count

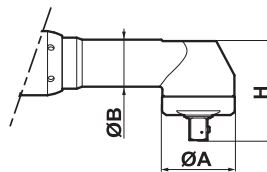

• PRODUCTIVITY

- High speed with joint stiffness capability

• QUALITY

- High accuracy with immediate shut off
- Improve your process quality with FAS3000

• ERGONOMY

- Low reaction force on hard joint

• DURABILITY

- Low frequency maintenance
- Quick service time



MODEL	ANGLE HEAD DIMENSIONS					
	ØA		ØB		H	
	mm	in.	mm	in.	mm	in.
SH70	20	0.79	20	0.79	36.6	1.44
SH150	22	0.87	21	0.83	35.2	1.38
SH200	27	1.06	27	1.06	45.5	1.79
SH280	27	1.06	24	0.94	41.5	1.63
SH420	40	1.57	29	1.10	56.5	2.20
SH500	40	1.57	29	1.10	56.5	2.20
SH700	40	1.57	29	1.10	56.5	2.20
SH850	51	2.00	33	1.30	69.5	2.70
SH1200	51	2.00	33	1.30	69.5	2.70
SH2000	51	2.00	33	1.30	69.5	2.70

Accessories: see page 106

PIC REF	MODEL	PART NUMBER	BOLT SIZE	FREE SPEED	SQUARE DRIVE	TORQUE RANGE		LENGTH		WEIGHT		AIR FLOW		AIR INLET		HOSE INT. Ø	
						Nm	in.lb	mm	in.	kg	lb.	l/s	cfm	in.	mm	in.	
A	SH70-LR1100-S90-A4S	205 147 628 4	M5	1100	1/4	2.5-7	22.1-61.9	334	13.1	1.3	2.9	8	17	1/4	8	5/16	
B	SH150-LR580-S90-A10S	205 147 629 4	M6	560	3/8	7-15	61.9-44.2	349	13.7	1.4	3.1	10	21	1/4	10	3/8	
B	SH200-LR550-S90-A10S	205 147 630 4	M6	530	3/8	10-19	88.5-168	355	14.0	1.4	3.1	10	21	1/4	10	3/8	
B	SH280-LR350-S90-A10S	205 147 631 4	M8	340	3/8	14-28	124-248	350	13.8	1.4	3.1	10	21	1/4	10	3/8	
B	SH280-LR80-S90-A10S	205 147 632 4	M8	80	3/8	14-28	124-248	350	13.8	1.4	3.1	10	21	1/4	10	3/8	
C	SH420-LR400-S90-A10S	205 147 800 4	M10	400	3/8	20-42	177-372	436	17.2	2.0	4.4	16	34	1/4	10	3/8	
C	SH500-LR330-S90-A13S	205 147 473 4	M10	330	1/2	25-50	221-442	453	17.8	2.2	4.8	16	34	1/4	10	3/8	
D	SH700-LR225-S90-A13S	205 147 474 4	M10-M12	225	1/2	34-70	301-619	487	19.2	2.4	5.3	16	34	1/4	10	3/8	
D	SH850-LR190-S90-A13S	205 147 475 4	M12	190	1/2	40-85	354-752	530	20.8	2.8	6.1	16	34	1/4	10	3/8	
E	SH1200-LR215-S90-A13S	205 147 476 4	M12-M14	215	1/2	70-120	354-1062	590	23.2	3.5	7.6	28	59	1/2	13	1/2	
E	SH2000-LR100-S90-A13S	205 147 801 4	M12-M14	100	1/2	115-200	1018-1770	608	23.9	4.4	9.7	28	59	1/2	13	1/2	

Angle head - Non Shut off

0.4 to 19 Nm (3.5 to 168 in.lb) - 320 to 2000 rpm

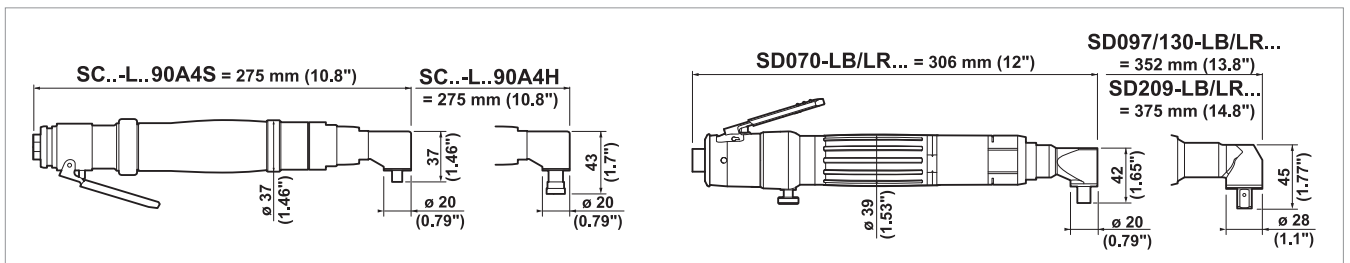
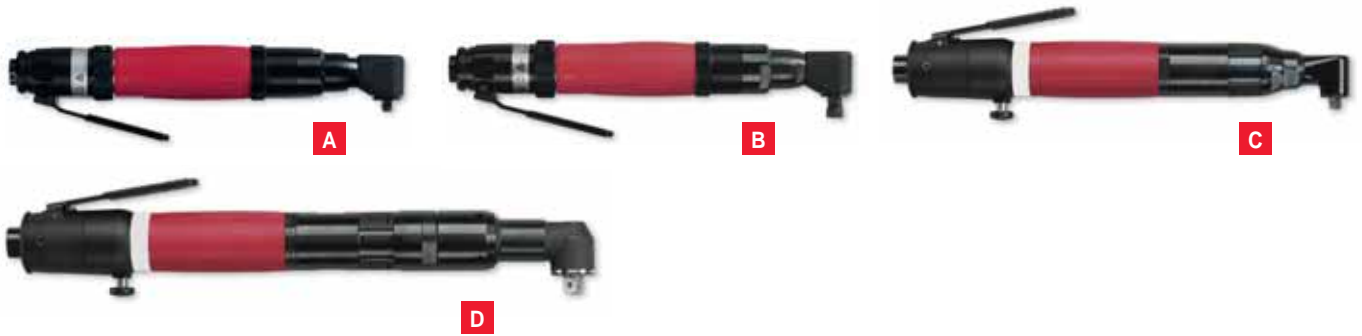

Accessories: see page 106

PIC REF	MODEL	PART NUMBER	FREE SPEED	OUTPUT DRIVE	TORQUE RANGE		FITTED SPRING		WEIGHT		AIR FLOW	AIR INLET	HOSE INT. Ø		
					Nm	in.lb	Nm	in.lb	kg	lb.			mm	in.	
			rpm	in.							l/s	cfm	in.	mm	in.
A	SC024-L2000-R90A4S	1459194	2000	1/4 sq	0.5-2.4	4.4-21.2	0.5-1.8	4.4-15.9	0.84	1.85	6.5	13.8	1/8	6	1/4
A	SC022-L1400-R90A4S	1459184	1400	1/4 sq	0.5-2.2	4.4-19.5	0.8-2.2	7.1-19.5	0.84	1.85	6.5	13.8	1/8	6	1/4
A	SC044-L950-R90A4S	1459174	950	1/4 sq	0.4-4.4	3.5-38.9	1.3-4.4	11.5-38.9	0.84	1.85	6.5	13.8	1/8	6	1/4
A	SC044-L500-R90A4S	1459164	500	1/4 sq	0.4-4.4	3.5-38.9	1-4.4	8.9-38.9	0.84	1.85	6.5	13.8	1/8	6	1/4
B	SC024-L2000-R90A4H	1459114	2000	1/4 hex	0.5-2.4	4.4-21.2	0.5-1.8	4.4-15.9	0.84	1.85	6.5	13.8	1/8	6	1/4
B	SC022-L1400-R90A4H	1459104	1400	1/4 hex	0.5-2.2	4.4-19.5	0.8-2.2	7.1-19.5	0.84	1.85	6.5	13.8	1/8	6	1/4
B	SC044-L950-R90A4H	1459094	950	1/4 hex	0.4-4.4	3.5-38.9	1.3-4.4	11.5-38.9	0.84	1.85	6.5	13.8	1/8	6	1/4
B	SC044-L500-R90A4H	1459084	500	1/4 hex	0.4-4.4	3.5-38.9	1-4.4	8.9-38.9	0.84	1.85	6.5	13.8	1/8	6	1/4
C	SD070-LB1100-R90-A4H	1463334	1100	1/4 hex	2.5-7	22-61.9	2.5-7	22-61.9	1.12	2.47	8.7	18.4	1/4	10	3/8
C	SD070-LB820-R90-A4H	1463324	820	1/4 hex	2.5-7	22-61.9	2.5-7	22-61.9	1.12	2.47	8.7	18.4	1/4	10	3/8
C	SD070-LB510-R90-A4H	1463314	510	1/4 hex	2.5-7	22-61.9	2.5-7	22-61.9	1.12	2.47	8.7	18.4	1/4	10	3/8
C	SD070-LB320-R90-A4H	1463304	320	1/4 hex	2.5-7	22-61.9	2.5-7	22-61.9	1.12	2.47	8.7	18.4	1/4	10	3/8
C	SD070-LR1100-R90-A4H	1463654	1100	1/4 hex	2.5-7	22-61.9	2.5-7	22-61.9	1.12	2.47	8.7	18.4	1/4	10	3/8
C	SD070-LR820-R90-A4H	1463644	820	1/4 hex	2.5-7	22-61.9	2.5-7	22-61.9	1.12	2.47	8.7	18.4	1/4	10	3/8
C	SD070-LR510-R90-A4H	1463634	510	1/4 hex	2.5-7	22-61.9	2.5-7	22-61.9	1.12	2.47	8.7	18.4	1/4	10	3/8
C	SD070-LR320-R90-A4H	1463624	320	1/4 hex	2.5-7	22-61.9	2.5-7	22-61.9	1.12	2.45	8.7	18.4	1/4	10	3/8
C	SD070-LB1100-R90-A4S	1463454	1100	1/4 sq	2.5-7	22-61.9	2.5-7	22-61.9	1.11	2.45	8.7	18.4	1/4	10	3/8
C	SD070-LB820-R90-A4S	1463444	820	1/4 sq	2.5-7	22-61.9	2.5-7	22-61.9	1.11	2.45	8.7	18.4	1/4	10	3/8
C	SD070-LB510-R90-A4S	1463434	510	1/4 sq	2.5-7	22-61.9	2.5-7	22-61.9	1.11	2.45	8.7	18.4	1/4	10	3/8
C	SD070-LB320-R90-A4S	1463424	320	1/4 sq	2.5-7	22-61.9	2.5-7	22-61.9	1.11	2.45	8.7	18.4	1/4	10	3/8
C	SD070-LR1100-R90-A4S	1463694	1100	1/4 sq	2.5-7	22-61.9	2.5-7	22-61.9	1.11	2.45	8.7	18.4	1/4	10	3/8
C	SD070-LR820-R90-A4S	1463684	820	1/4 sq	2.5-7	22-61.9	2.5-7	22-61.9	1.11	2.45	8.7	18.4	1/4	10	3/8
C	SD070-LR510-R90-A4S	1463674	510	1/4 sq	2.5-7	22-61.9	2.5-7	22-61.9	1.11	2.45	8.7	18.4	1/4	10	3/8
C	SD070-LR320-R90-A4S	1463664	320	1/4 sq	2.5-7	22-61.9	2.5-7	22-61.9	1.11	2.45	8.7	18.4	1/4	10	3/8
D	SD097-LB1080-R90-A10S	1463584	1080	3/8 sq	3-9.7	26.5-85.8	3-9.7	26.5-85.8	1.41	3.11	8.7	18.4	1/4	10	3/8
D	SD130-LB600-R90-A10S	1463574	600	3/8 sq	4.5-12	39.8-106	4.5-12	39.8-106	1.41	3.11	8.7	18.4	1/4	10	3/8
D	SD209-LB370-R90-A10S	1463564	370	3/8 sq	6-19	53.1-168	6-19	53.1-168	1.50	3.31	8.7	18.4	1/4	10	3/8
D	SD097-LR1080-R90-A10S	1463724	1080	3/8 sq	3-9.7	26.5-85.8	3-9.7	26.5-85.8	1.41	3.11	8.7	18.4	1/4	10	3/8
D	SD130-LR600-R90-A10S	1463714	600	3/8 sq	4.5-12	39.8-106	4.5-12	39.8-106	1.41	3.11	8.7	18.4	1/4	10	3/8
D	SD209-LR370-R90-A10S	1463704	370	3/8 sq	6-19	53.1-168	6-19	53.1-168	1.50	3.31	8.7	18.4	1/4	10	3/8

Angle Head - Direct drive

1.5 to 105 Nm (13.3 to 929 in.lb) - 60 to 800 rpm

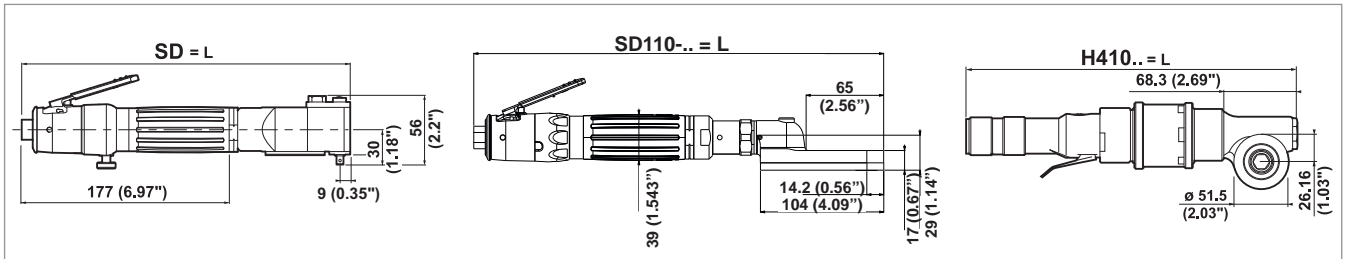

SD - Stall Torque (Nm) Setting using Regulator Part No. 81223

Accessories: see page 106

MODEL	REGULATOR POSITION						
	1	2	3	4	5	6	Open
Inlet Pressure - 6.3 bar							
SD130-LB500-D90-A4S	3.2	3.5	5.3	7.0	10.0	12.5	13.0
SD096-LB800-D90-A4S	2.6	2.8	4.0	5.5	7.3	9.0	9.6
Inlet Pressure - 4.0 bar							
SD130-LB500-D90-A4S	2.0	2.7	3.0	4.2	6.0	8.2	9.0
SD096-LB800-D90-A4S	1.5	1.7	2.5	3.0	4.5	5.5	6.0

H410 - Stall Torque (Nm) Setting using a Typical Regulator

MODEL	REGULATOR POSITION									
	10%	20%	30%	40%	50%	60%	70%	80%	90%	Open
Inlet Pressure - 6.3 bar										
H410-N-500	3	6	9	12	15	18	21	24	27	30
H410-N-350	5	9	14	18	23	27	32	36	41	45
H410-N-150	8	16	24	32	40	48	56	64	72	80
H410-N-90	16	32	48	63	79	95	-	-	-	-
H410-N-60	20	40	60	80	-	-	-	-	-	-
Inlet Pressure - 4.0 bar										
H410-N-500	2	4	6	8	9	11	13	15	17	19
H410-N-350	3	6	9	11	14	17	20	23	26	28
H410-N-150	5	10	15	20	25	30	35	40	45	50
H410-N-90	10	20	30	40	50	60	70	80	90	100
H410-N-60	4	30	45	60	75	90	105	-	-	-

Maximum stall torque 105Nm

Performance will differ from the figures above depending on the regulator used

Data obtained from a lubricated air line

Torque figures are to be used as a guide only

* Must never be used without regulator with a pressure higher than 4 bars

** Must never be used without regulator with a pressure higher than 2 bars

H410-N – When using direct drive screwdrivers, it is strongly advised to equip the machines with a reaction bar to compensate against potentially high torque reaction and avoid operator injury

PIC REF	MODEL	PART NUMBER	FREE SPEED	OUTPUT DRIVE	TORQUE RANGE		LENGTH L		WEIGHT		AIR FLOW	AIR INLET	HOSE INT. Ø		
			rpm	in.	Nm	in.lb	mm	in.	kg	lb.	l/s	cfm	in.	mm	in.
A	SD130-LB500-D90-A4S	1465974	500	1/4 sq	2-13	17.7-115	326	12.8	1.08	2.38	8.7	18.4	1/4	10	3/8
A	SD096-LB800-D90-A4S	1465984	800	1/4 sq	1.5-9.6	13.3-85	326	12.8	1.08	2.38	8.7	18.4	1/4	10	1/4
B	SD110-LX450	205 148 131 4	450	0.445 hex	1.5-11.8	13.3-104	346	13.6	1.34	2.95	8.5	18.0	1/4	10	1/4
C	H410-N-500	1302374	500	0.525 hex	3-30	26.6-265	319	12.6	1.70	3.74	17.9	37.9	3/8	12	1/2
C	H410-N-350	1302454	350	0.525 hex	4.5-45	39.8-398	319	12.6	1.70	3.74	17.9	37.9	3/8	12	1/2
C	H410-N-150	1302534	150	0.525 hex	8-80	70.8-708	358	14.1	2.00	4.41	17.9	37.9	3/8	12	1/2
C	H410-N-90*	1302614	90	0.525 hex	10-105	88.5-929	358	14.1	2.00	4.41	13.2	27.9	3/8	12	1/2
C	H410-N-60**	1302794	60	0.525 hex	10-105	88.5-929	358	14.1	2.00	4.41	13.2	27.9	3/8	12	1/2

Crowfoot and Tube nut tools - Angle head

4 to 41 Nm (35 to 363 in.lb) - 240 to 430 rpm



MODEL	ACROSS FLATS	E		F		G		H	
		mm	mm in.	mm in.	mm in.	mm in.	mm in.		
SH330-LB430-CE13-CC53	13	19	0.75	32	1.26	N/A	52.8	2.07	
SH410-LB400-CE17-CC68	17	19	0.75	39	1.54	N/A	67.6	2.66	
SH330-LB330-OE11-CC53	11	18	0.71	40	1.57	10.4	0.41	52.9	2.08
SH330-LB330-OE11-CC75	11	18	0.71	40	1.57	10.4	0.41	75.3	2.96
SH330-LB330-OE13-CC53	13	18	0.71	40	1.57	10.4	0.41	52.9	2.08
SH330-LB330-OE13-CC75	13	18	0.71	40	1.57	10.4	0.41	75.3	2.96
SD160-LB240-S-OE17-CC92	17	14	0.55	48	1.89	12	0.47	91.5	3.60
SD160-LB240-S-OE13-CC80	13	12	0.47	38	1.49	7	0.27	79.6	3.13
SD160-LB240-S-OE12-CC80	12	12	0.47	38	1.49	7	0.27	79.6	3.13
SD160-LB240-S-OE10-CC80	10	12	0.47	38	1.49	7	0.27	79.6	3.13

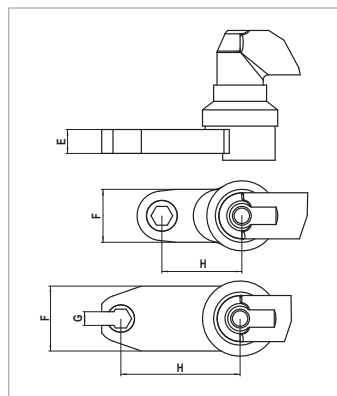

- * Up to 14mm sockets possible as an option
- * Possibility to have extension drive sockets
- * Contact your local Desoutter sales engineer for all other requests

Accessories: see page 106



PIC REF	MODEL	PART NUMBER	FREE SPEED	ACROSS FLATS	TORQUE RANGE		LENGTH		WEIGHT		AIR FLOW		AIR INLET	HOSE INT. Ø	
					Nm	in.lb	mm	in.	kg	lb.	l/s	cfm		in.	mm

OFFSET CROWFOOT TOOLS - SHUT OFF

A	SH330-LB430-CE13-CC53	205 147 815 4	430	13	16-33	142-212	508	20.0	2.6	5.7	18	38.1	1/4	10	3/8
A	SH410-LB400-CE17-CC68	205 147 817 4	400	17	18-41	159-363	600	23.6	3.9	8.6	28	59.3	1/2	10	3/8

OFFSET TUBE NUT TOOLS - SHUT OFF

B	SH330-LB330-OE11-CC53	205 147 818 4	330	11	16.5-33	146-292	498.3	19.6	2.7	5.9	18	38.1	1/4	10	3/8
B	SH330-LB330-OE11-CC75	205 147 819 4	330	11	16.5-33	146-292	498.3	19.6	2.7	5.9	18	38.1	1/4	10	3/8
B	SH330-LB330-OE13-CC53	205 147 820 4	330	13	16.5-33	146-292	520.7	20.5	2.8	6.2	18	38.1	1/4	10	3/8
B	SH330-LB330-OE13-CC75	205 147 821 4	330	13	16.5-33	146-292	520.7	20.5	2.8	6.2	18	38.1	1/4	10	3/8

OFFSET TUBE NUT TOOLS - SHUT OFF

C	SD160-LB240-S-OE17-CC92	1463594	240	17	7-16	62-142	453	17.8	1.9	4.2	8.7	18.4	1/4	10	3/8
C	SD160-LB240-S-OE13-CC80	1463604	240	13	7-16	62-142	453	17.8	1.8	4.0	8.7	18.4	1/4	10	3/8
C	SD160-LB240-S-OE12-CC80	1463614	240	12	7-16	62-142	453	17.8	1.8	4.0	8.7	18.4	1/4	10	3/8
C	SD160-LB240-S-OE10-CC80	1463734	240	10	7-16	62-142	453	17.8	1.8	4.0	8.7	18.4	1/4	10	3/8
•	SD160-LB240-S-OE	1464474	240	3/8" Sq	7-16	62-142			1.5	3.3	8.7	18.4	1/4	10	3/8

Torque Controlled - Shut Off

0.5 to 16 Nm (4.4 to 142 in.lb) - 320 to 3500 rpm



Signal

M5 Port provides signal while tool is running
The signal stops when the clutch operates

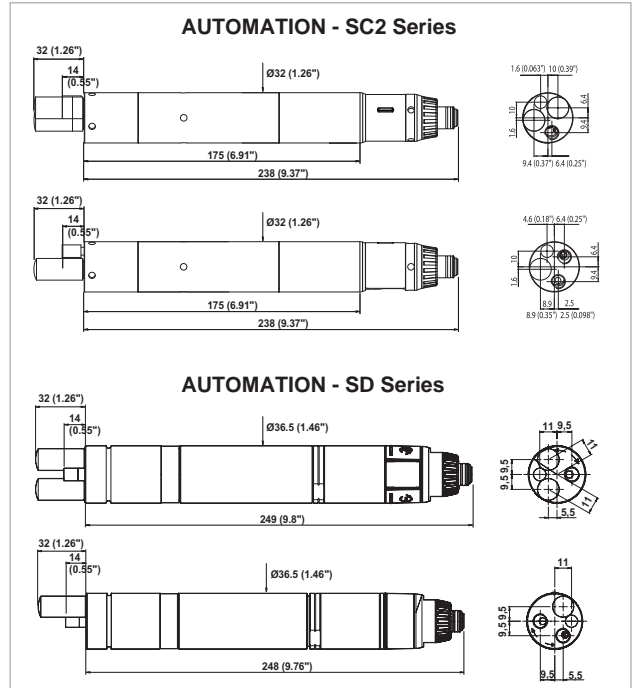

Accessories: see page 107

PIC REF	MODEL	PART NUMBER	FREE SPEED	OUTPUT HEX	TORQUE RANGE		FITTED SPRING		WEIGHT		AIR FLOW		AIR INLET		HOSE INT. Ø	
					rpm	in.	Nm	in.lb	Nm	in.lb	kg	lb.	l/s	cfm	in.	mm
AUTOMATION - PUSH START - SHUT OFF - 1 WAY																
A	SC2-025-1AM2200-S4Q	205 147 426 4	2150	1/4	0.5-2.5	4.4-22	0.5-2.5	4.4-22.1	0.64	1.41	7	14.8	1/8	6	1/4	
A	SC2-035-1AM1500-S4Q	205 147 425 4	1450	1/4	0.5-3.5	4.4-30.8	1.7-3.5	15-30.9	0.64	1.41	7	14.8	1/8	6	1/4	
A	SC2-045-1AM1000-S4Q	205 147 424 4	1000	1/4	0.5-4.5	4.4-39.6	1.7-4.5	15-39.8	0.64	1.41	7	14.8	1/8	6	1/4	
A	SC2-055-1AM700-S4Q	205 147 423 4	670	1/4	0.5-5.5	4.4-48.4	3-5.5	26.5-48.6	0.64	1.41	7	14.8	1/8	6	1/4	
A	SC2-065-1AM500-S4Q	205 147 422 4	470	1/4	0.5-6.5	4.4-57.2	3-6.5	26.5-57.5	0.64	1.41	7	14.8	1/8	6	1/4	
AUTOMATION - REMOTE START - SHUT OFF - 2 WAY																
B	SC2-025-2RM2200-S4Q	205 147 440 4	2150	1/4	0.5-2.5	4.4-22	0.5-2.5	4.4-22.1	0.64	1.41	7	14.8	1/8	6	1/4	
B	SC2-035-2RM1500-S4Q	205 147 439 4	1450	1/4	0.5-3.5	4.4-30.8	1.7-3.5	15-30.9	0.64	1.41	7	14.8	1/8	6	1/4	
B	SC2-045-2RM1000-S4Q	205 147 438 4	1000	1/4	0.5-4.5	4.4-39.6	1.7-4.5	15-39.8	0.64	1.41	7	14.8	1/8	6	1/4	
B	SC2-055-2RM700-S4Q	205 147 437 4	670	1/4	0.5-5.5	4.4-48.4	3-5.5	26.5-48.6	0.64	1.41	7	14.8	1/8	6	1/4	
B	SC2-065-2RM500-S4Q	205 147 436 4	470	1/4	0.5-6.5	4.4-57.2	3-6.5	26.5-57.5	0.64	1.41	7	14.8	1/8	6	1/4	
AUTOMATION - PUSH START - SHUT OFF - 1 WAY																
C	SD023-1AM3500-S4Q	1464254	3500	1/4	1.0-2.3	8.8-20.4	1.0-2.3	8.8-20.4	0.92	2.03	8.7	18.4	1/8	10	3/8	
C	SD035-1AM2200-S4Q	1464244	2200	1/4	1.0-3.5	8.8-31	1.0-3.5	8.8-30.9	0.92	2.03	8.7	18.4	1/8	10	3/8	
C	SD055-1AM1470-S4Q	1464234	1470	1/4	2.0-5.5	18-48.7	2.0-5.5	18-48.7	0.92	2.03	8.7	18.4	1/8	10	3/8	
C	SD075-1AM1100-S4Q	1464224	1100	1/4	2.5-7.5	22-66.4	2.5-7.5	22-66.4	0.92	2.03	8.7	18.4	1/8	10	3/8	
C	SD100-1AM820-S4Q	1464214	820	1/4	3.5-10	31-88.5	3.5-10	31-88.5	0.92	2.03	8.7	18.4	1/8	10	3/8	
C	SD140-1AM510-S4Q	1464204	510	1/4	3.5-14	31-124	3.5-10	31-88.5	0.92	2.03	8.7	18.4	1/8	10	3/8	
C	SD160-1AM320-S4Q	1464194	320	1/4	3.5-16	31-142	3.5-10	31-88.5	0.92	2.03	8.7	18.4	1/8	10	3/8	
AUTOMATION - REMOTE START - SHUT OFF - 2 WAY																
D	SD023-2RM3500-S4Q	1464324	3500	1/4	1.0-2.3	8.8-20.4	1.0-2.3	8.8-20.4	0.92	2.03	8.7	18.4	1/8	10	3/8	
D	SD035-2RM2200-S4Q	1464314	2200	1/4	1.0-3.5	8.8-31	1.0-3.5	8.8-30.9	0.92	2.03	8.7	18.4	1/8	10	3/8	
D	SD055-2RM1470-S4Q	1464304	1470	1/4	2.0-5.5	18-48.7	2.0-5.5	18-48.7	0.92	2.03	8.7	18.4	1/8	10	3/8	
D	SD075-2RM1100-S4Q	1464294	1100	1/4	2.5-7.5	22-66.4	2.5-7.5	22-66.4	0.92	2.03	8.7	18.4	1/8	10	3/8	
D	SD100-2RM820-S4Q	1464284	820	1/4	3.5-10	31-88.5	3.5-10	31-88.5	0.92	2.03	8.7	18.4	1/8	10	3/8	
D	SD140-2RM510-S4Q	1464274	510	1/4	3.5-14	31-124	3.5-10	31-88.5	0.92	2.03	8.7	18.4	1/8	10	3/8	
D	SD160-2RM320-S4Q	1464264	320	1/4	3.5-16	31-142	3.5-10	31-88.5	0.92	2.03	8.7	18.4	1/8	10	3/8	

Accessories

STRAIGHT - PUSH START & LEVER START

ACCESSORIES INCLUDED

ITEM	2A89	SB	SC2	SD
• Suspension bail(s)	280903	443703	205 049 537 3	467003
• Suspension bail internal			205 051 289 3	
• Exhaust hose	280913	443723	205 049 584 3	467073
• Clutch adjustment keys	292583	446583	205 050 785 3	29932
1 Short lever (lever start model)			205 052 020 3	
2 Rings identification			205 049 590 3	
3 Side handle assembly				467033

OPTIONAL ACCESSORIES

ITEM	2A89	SB	SC2	SD
3 Side handle assembly			205 052 175 3	
• Double-ended bit holder			205 052 883 3	465523

Balancers & Tool Holster

4 Spring suspension balancer	52542	50522	50522	52862
5 Hose reel balancer	52552	50552	50552	50562
6 Reaction free self-lock balancer			54422	54432
7 Tool holster DTH-42	107892	107892	107892	107892

Bench Stands (for more information, see pages 136-143)

8 D53-25 Linear arm (tool clamp included)		615 810 701 0	615 810 701 0	615 810 701 0
8 D53-25X Linear arm (tool clamp included)		615 810 703 0	615 810 703 0	615 810 703 0
9 D53-25S Folder arm (tool clamp included)		615 810 708 0	615 810 708 0	615 810 708 0
10 D57 Balancing arm		408903	408903	408903
• Tool clamp		615 396 614 0	615 396 614 0	615 396 614 0
10 D57X Balancing arm		408913	408913	408913
• Tool clamp		615 396 614 0	615 396 614 0	615 396 614 0
11 D58 Balancing arm		408923	408923	408923
• Tool clamp		615 396 614 0	615 396 614 0	615 396 614 0
12 Bench mounted swinging arm for use with balancer		66542	66542	66542
13 TRA12 Telescopic reaction arm			(see page 141)	
13 TRA25 Telescopic reaction arm			(see page 141)	

Vacuum Pick Up - Order Pick Up kit, Finder Sleeve & Vacuum Source

14 Vacuum pick up kit (spring only for 2A89)	280443	108892		108892
15 Finder sleeve blank - plastic		464093		464093
• Finder sleeve blank - steel	88992	464103		464103
16 Vacuum source for use with DU balancer (lever start model)				51482
17 Vacuum source AV201 for use with filter/regulator unit				112063

Miscellaneous

18 Offset exhaust				205 047 623 3
• Clutch case 7/8" LH thread 320-1470 rpm				205 047 478 3
• Clutch case 7/8" LH thread 2200-3500 rpm				205 047 479 3
• Clutch case without thrust bump, M20x1.0LH thread 320-1470 rpm				465463
• Clutch case without thrust bump, M20x1.0LH thread 2200-3500 rpm				465443

PISTOL GRIP & HLT

ACCESSORIES INCLUDED

	SCBP	SBP	SCP SCPT	SDP SDT
• Suspension bail(s)	307683	307683	307683	473153
• Side handle (320 & 1470 rpm)				467033
• Clutch adjustment keys (320 - 1470 rpm)	205 047 988 3	446583	29932	29932
• Clutch adjustment keys (2200 - 3500 rpm)				467293

OPTIONAL ACCESSORIES

	SBP SCBP	SCP SCPT	SDP SDT
--	-------------	-------------	------------

Balancers & Holster

1 Spring suspension balancer		52862	52862	52862
2 Hose reel balancer		50552	50552	50562
• Hose reel balancer conversion kit		107403	107403	115193
3 Reaction free self-lock balancer		54422	54422	54432
4 Tool holster DTH-42		107892	107892	107892

Bench Stands (for more information, see pages 142-143)

5 D59 Pantographic arm		408933	408933	408933
------------------------	--	--------	--------	--------

Miscellaneous

6 Bench mounted swing arm for use with balancer		66542	66542	66542
7 Side handle		70442	70442	467033

DIRECT DRIVE

ACCESSORIES INCLUDED

	SDP	SD	H410
• Suspension bail(s)	473153		467003
• Side handle	467033		
• Exhaust hose		467073	

OPTIONAL ACCESSORIES

ITEM	SDP	SD	H410
• Air flow regulator	81223	81223	
Balancers & Holster			
1 Spring suspension balancer	52862	50532	50542
2 Hose reel balancer	50562	50562	
3 Reaction free self-lock balancer	54432	54432	54442
4 Tool holster DTH-42	107892	107892	

Suspension Shackle

5 Suspension shackle		70082	615 571 050 0
• Swivel suspension shackle			615 396 229 0

Bench Stands (for more information, see pages 142-143)

6 D59 Pantographic arm	408933		
------------------------	--------	--	--

Miscellaneous

7 Side handle	467033		
• Offset exhaust		205 047 623 3	
8 Bench mounted swing arm	66542	66542	66542
• Square drive adaptor 3/8" Square drive, 48mm (1.89") long			14422
• Square drive adaptor 1/2" Square drive, 46mm (1.81") long			14442
• Square drive adaptor 1/2" Square drive, 76mm (2.99") long			14482
• Exhaust collector			72163



AUTO REVERSE

ACCESSORIES INCLUDED

	SD
• Suspension bail(s)	467003
• Side handle	467033
• Clutch adjustment keys	29932

OPTIONAL ACCESSORIES

ITEM	SD
Placement of Threaded Inserts	
1 M3 x 0.5 Nose kit	76552
1 M4 x 0.7 Nose kit	76562
1 M5 x 0.8 Nose kit	76572
1 M6 x 1.0 Nose kit	76582
1 M8 x 1.25 Nose kit	76592

Blind Hole Tapping/ Cleaning - 3 parts Required

• Bit adaptor*	465513
2 Thread adaptor	96743
3 Chuck capacity 8mm (5/16")	28942

Balancers & Tool Holster

4 Spring suspension balancer	50532
5 Reaction free self-lock balancer	54432
6 Tool holster DTH-42	107892

Bench Stands (for more information, see pages 142-143)

7 D57 Balancing arm	408903
• Tool clamp	615 396 614 0
7 D57X Balancing arm	408913
• Tool clamp	615 396 614 0
8 D58 Balancing arm	408923
• Tool clamp	615 396 614 0
9 Bench mounted swinging arm for use with balancer	66542
10 TRA25 Telescopic reaction arm	(see page 141)

* To order more clutch cover PN 465453 + washer PN 467113



Accessories

ANGLE HEAD

ACCESSORIES INCLUDED

	SC	SD	SH
• Suspension bail(s)	39433/280893	467003	
• Exhaust hose	396553	467073	
• Adjustment keys	29932	29932	205 050 785 3
• Air hose nipple			205 051 239 3

OPTIONAL ACCESSORIES

ITEM	2D4872	SC	SD	SH
• Exhaust hose for SH70/150/200/280/420/500/700/850				459813
• Exhaust hose for SH1200/2000				205 050 181 3

Balancers & Holster

1 Spring suspension balancer	50532	52862	50532	
1 Spring suspension balancer for SH70/150/200/280				52862
2 Spring suspension balancer for SH420 to SH2000				50052
3 Hose reel balancer	50562	50552	50562	
3 Hose reel balancer for SH70/150/200/280				50562
4 Reaction free self-lock balancer	54432	54422	54432	
4 Reaction free self-lock balancer for SH70/150/200/280				54432

Suspension Shackle

• Suspension shackle	95842	70082		
----------------------	-------	-------	--	--

Suspension bails

5 Suspension bail for SH70/150/200/280				205 051 632 3
5 Suspension bail for SH420/500/700/850				205 051 113 3
5 Suspension bail for SH1200/2000				615 396 562 0

Swiveling bails

6 Swiveling bail for SH420/500/750/850				205 051 115 3
6 Swiveling bail for SH1200/2000				205 051 232 3

Bench Stands (for more information, see pages 142-143)

7 D53-25 Linear arm (tool clamp included)	615 810 701 0	615 810 701 0	4615 810 701 0	615 810 704 0
7 D53-25X Linear arm, extended reach	615 810 703 0	615 810 703 0	615 810 703 0	
8 D53-25S Folder arm (tool clamp included)	615 810 707 0	615 810 707 0	615 810 707 0	615 810 709 0

Bench Stands (for more information, see pages 142-143)

9 D57 Balancing arm	408903	408903	408903	
• Tool clamp	615 396 614 0	615 396 614 0	615 396 614 0	
9 D57X Balancing arm	408913	408913	408913	
• Tool clamp	615 396 614 0	615 396 614 0	615 396 614 0	
10 D58 Balancing arm	408923	408923	408923	
• Tool clamp	615 396 614 0	615 396 614 0	615 396 614 0	
11 TRA12 Telescopic reaction arm		(see page 141)		
11 TRA25 Telescopic reaction arm		(see page 141)		

Miscellaneous

• Offset exhaust			205 047 623 3	
• Bench mounted swing arm	66542	66542	66542	66542
12 Protective cover for SH70/150/200/280				205 011 426 2
12 Protective cover for SH420/500				205 050 182 3
12 Protective cover for SH700/850				205 050 235 3
12 Protective cover for SH1200/2000				205 050 252 3
13 Complete reaction bar kit for SH850/1200/2000				205 051 121 3
14 Reporting kit for SH70 (for connexion with FAS)				205 011 424 2
14 Reporting kit for SH150/200/280 (for connexion with FAS)				205 011 425 2
14 Reporting kit for SH420/500/700/850 (for connexion with FAS)				205 050 175 3
14 Reporting kit for SH1200/2000 (for connexion with FAS)				205 050 176 3

OPEN ENDED WRENCHES

ACCESSORIES INCLUDED

	SD
• Suspension bail(s)	467003
• Exhaust hose	467073
• Clutch adjustment keys	29932

OPTIONAL ACCESSORIES

ITEM	SD
------	----

Balancers

1 Spring suspension balancer	50542
2 Hose reel balancer	50562
3 Reaction free self-lock balancer	54442

Suspension Shackle

4 Suspension shackle	70082
----------------------	-------

Bench Stands (for more information, see pages 142-143)

5 D57 Balancing arm	408903
• Tool clamp	615 396 614 0
5 D57X Balancing arm	408913
• Tool clamp	615 396 614 0
6 D58 Balancing arm	408923
• Tool clamp	615 396 614 0

Miscellaneous

• Offset exhaust	205 047 623 3
• Bench mounted swing arm	66542



TORQUE CONTROLLED



ACCESSORIES INCLUDED

ITEM	SC2 / SD
1 Muffler	205 045 792 3
2 Straight fitting	205 044 497 3

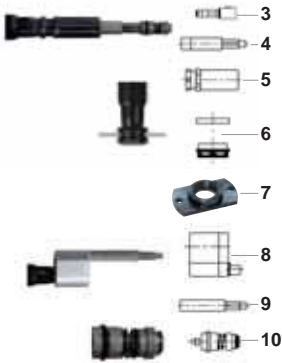

OPTIONAL ACCESSORIES

ITEM	PART NO.
• Spring Loaded Shats and Bearings Support (including 3, 4, 5)	
3 Bit Adaptor	103782
4 Spring Loaded Shaft 25mm (1")	108342
5 Shaft Support and Nose Mount	108412
6 Nose Mounts	205 052 876 3
7 Flange M20	205 052 875 3
• Offset Head & Spring Loaded shaft (Including 8, 9)	
8 Offset Head , offset 30mm (1.18")	384993
9 Spring Loaded Shaft 25mm (1") stroke	108342
10 3/8" Square to 1/4" Hex Power Adaptor	108322

Pulse Tools - Non Shut off and Shut Off range

5 to 172 Nm (3.6 to 127 ft.lb) - 3400 to 6700 rpm



Air inlet: All models 1/4" PT

PIC REF	MODEL	PART NUMBER	FREE SPEED	OUTPUT DRIVE	TORQUE RANGE		DIMENSIONS			WEIGHT		AIR FLOW		HOSE INT. Ø				
					rpm	in.	Nm	ft.lb	L	X	H	kg	lb	l/s	cfm	mm	in.	
NON SHUT OFF																		
A	PTF020-T6700-I4Q	615 172 101 0	6700	1/4 Hex	9-20	6.6-14.7	140	5.5	22	0.87	169	6.6	0.80	1.7	6.0	12.7	6	1/4
A	PTF028-T6300-I4Q	615 172 102 0	6300	1/4 Hex	16-28	11.8-20.7	140	5.5	22	0.87	169	6.6	0.80	1.7	6.7	14.1	6	1/4
A	PTF035-T6700-I4Q	615 172 103 0	6700	1/4 Hex	20-35	14.7-25.8	152	6.0	22	0.87	169	6.6	0.80	1.7	7.0	14.8	10	3/8
B	PTF024-T6700-I10S	615 172 072 0	6700	3/8 Sq	16-24	11.8-17.7	139.5	5.5	22	0.87	165.7	6.5	0.79	1.7	6.0	12.7	6	1/4
B	PTF040-T6300-I10S	615 172 074 0	6300	3/8 Sq	20-40	14.7-29.5	139.5	5.5	22	0.87	165.7	6.5	0.79	1.7	6.7	14.2	10	3/8
B	PTF056-T6700-I10S	615 172 075 0	6700	3/8 Sq	28-56	20.7-41.3	151.5	5.9	22	0.87	165.7	6.5	0.83	1.8	7.0	14.8	10	3/8
B	PTF060-T6100-I10S	615 172 076 0	6100	3/8 Sq	36-60	26.5-44.2	155	6.1	24	0.94	170.0	6.7	1.02	2.2	10.0	21.2	10	3/8
B	PTF096-T4600-I13S	615 172 077 0	4600	1/2 Sq	52-96	38.3-70.8	173	6.8	27	1.06	175.0	6.9	1.45	3.2	10.8	22.9	10	3/8
B	PTF136-T5000-I13S	615 172 078 0	5000	1/2 Sq	80-136	59-100	182.5	7.2	29.5	1.16	186.5	7.3	1.80	4.0	13.3	28.2	10	3/8
B	PTF172-T3800-I13S	615 172 079 0	3800	1/2 Sq	120-172	88-127	191.5	7.6	32	1.26	192.0	7.6	2.10	4.6	14.2	30.1	10	3/8
SHUT OFF																		
A	PTF012-T6200-S4Q	615 172 104 0	6200	1/4 Hex	5-12	3.6-8.8	181	7.1	22	0.87	169	6.6	1.00	2.2	6.7	14.1	6	1/4
A	PTF022-T6500-S4Q	615 172 105 0	6500	1/4 Hex	11-22	8.1-16.2	181	7.1	22	0.87	169	6.6	1.00	2.2	7.5	15.9	6	1/4
A	PTF028-T6300-S4Q	615 172 106 0	6300	1/4 Hex	19-28	14.0-20.5	193	7.6	22	0.87	169	6.6	1.00	2.2	9.2	19.4	10	3/8
C	PTF012-T6200-S10S	615 172 081 0	6200	3/8 Sq	5-12	3.7-8.8	180.5	5.5	22	0.87	164.3	6.5	0.97	2.1	6.7	14.1	6	1/4
C	PTF024-T6500-S10S	615 172 084 0	6500	3/8 Sq	11-24	8.1-17.7	180.5	5.5	22	0.87	164.3	6.5	0.97	2.1	7.5	15.9	10	3/8
C	PTF035-T6300-S10S	615 172 087 0	6300	3/8 Sq	22-35	16.2-25.8	192.5	5.9	22	0.87	164.3	6.5	1.00	2.2	9.2	19.4	10	3/8
D	PTF060-T6100-S10S	615 172 088 0	6100	3/8 Sq	30-55	22.1-40.6	189.5	6.1	24	0.94	169.0	6.7	1.10	2.4	10	21.1	10	3/8
D	PTF085-T4800-S13S	615 172 089 0	4800	1/2 Sq	50-85	36.9-62.7	208.5	6.8	27	1.06	175.0	6.9	1.60	3.5	11.3	24.0	10	3/8
D	PTF130-T4500-S13S	615 172 090 0	4500	1/2 Sq	70-120	51.6-88.5	217.5	7.2	29.5	1.16	186.5	7.3	1.85	4.1	13.3	18.2	10	3/8
D	PTF165-T3400-S13S	615 172 091 0	3400	1/2 Sq	110-155	81-114	227.5	7.6	32	1.26	192.0	7.6	2.10	4.6	14.2	30.0	10	3/8

The tool is designed for a working pressure of 6.3 bar 90 PSI.

Pulse Tools - Tool Selection

Non Shut Off range

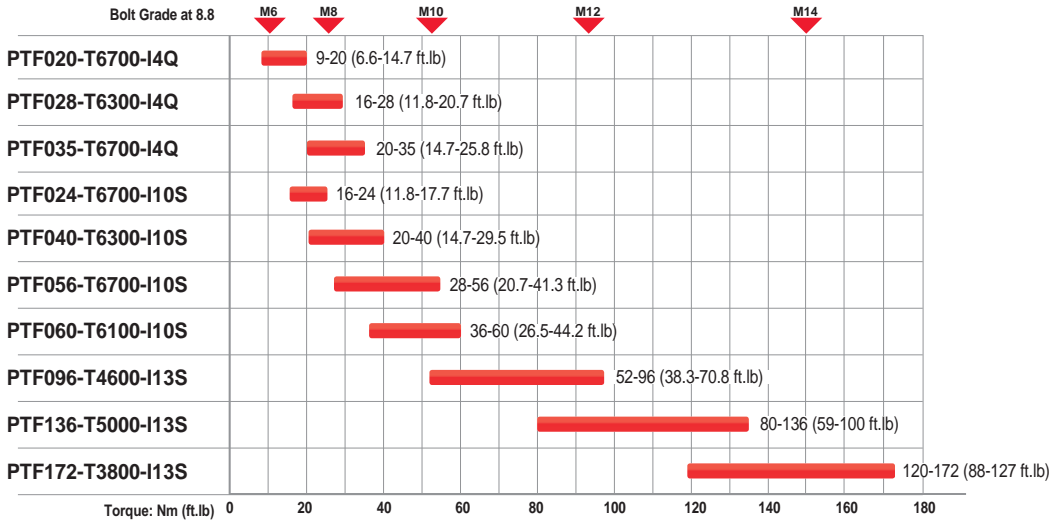

Shut Off range

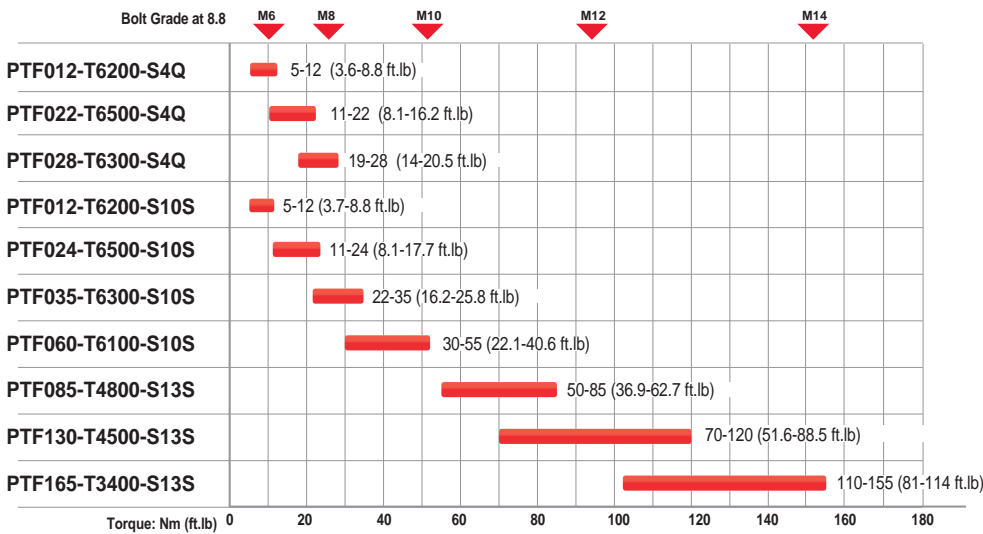

Accessories

ACCESSORIES INCLUDED

	PART NO.
• Air Hose nipple PTF012/024/040	541 205 445 0
• Air Hose nipple (other models)	541 205 445 2
• Suspension bail	541 205 847 4
• Hex pin wrench	-
Pulse Non Shut Off	
• Cover protection for PTF024/040...	541 206 045 6
• Cover protection for PTF060..	541 205 866 9
• Cover protection for PTF056..	541 206 028 6
• Cover protection for PTF096..	541 205 847 4
• Cover protection for PTF136..	541 206 046 0
• Cover protection for PTF172..	541 206 046 1

ACCESSORIES INCLUDED

	PART NO.
Pulse Shut Off	
• Cover protection for PTF012/022/024...	541 206 045 0
• Cover protection for PTF035...	541 206 045 1
• Cover protection for PTF060...	541 206 045 2
• Cover protection for PTF085...	541 206 045 3
• Cover protection for PTF130...	541 206 045 4
• Cover protection for PTF165...	541 206 045 5

Pulse Tools - Non Shut Off and Shut Off range

5 to 450 Nm (3.7 to 332 ft.lb) - 2800 to 10000 rpm

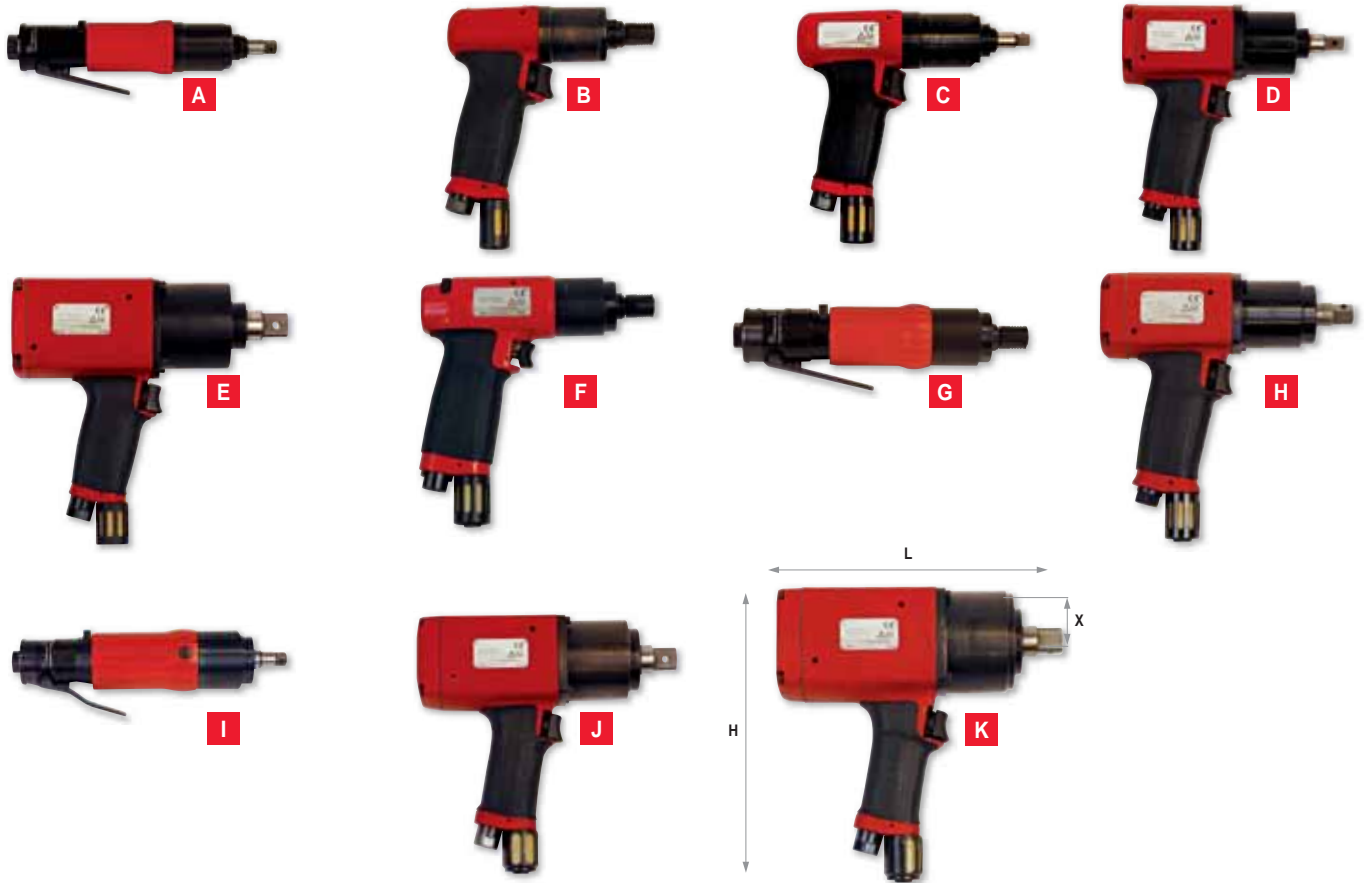

Air Inlet: All models 1/4" BSP, except PT160/240/250/450: 3/8" BSP – NPT optional

PIC REF	MODEL	PART NUMBER	FREE SPEED	OUTPUT DRIVE	TORQUE RANGE		DIMENSIONS						WEIGHT		AIR FLOW		HOSE INT. Ø	
					Nm	ft.lb	L	X		H		kg	lb.	l/s	cfm	mm	in.	
			rpm	in.			mm	in.	mm	in.	mm	in.					mm	in.
NON SHUT OFF																		
A	PT031-L10000-I10S	205 147 466 4	10000	3/8 Sq	20-31	15-23	221	8.7	22	0.87	-	-	0.7	1.5	8	17	8	5/16
B	PT028-T9000-I4Q	205 147 789 4	9000	1/4 Hex	17-28	13-21	150	5.9	22	0.87	175	6.9	0.8	1.8	8	17	8	5/16
C	PT031-T9000-I10S	205 147 467 4	9000	3/8 Sq	20-31	15-23	152	6.0	22	0.87	175	6.9	0.8	1.8	8	17	8	5/16
C	PT052-T7000-I10S	205 147 468 4	7000	3/8 Sq	30-52	22-38	174	6.8	23	0.90	175	6.9	1.0	2.0	9	19	10	3/8
D	PT070-T6000-I13S	205 147 469 4	6000	1/2 Sq	50-70	37-52	168	6.6	26	1.02	190	7.5	1.3	2.9	11	23	10	3/8
D	PT110-T4500-I13S	205 147 470 4	4500	1/2 Sq	65-110	48-81	178	7.0	29	1.14	198	7.8	1.6	3.5	12	25	10	3/8
D	PT160-T3500-I13S	205 147 471 4	3500	1/2 Sq	110-160	81-118	188	7.4	34	1.34	209	8.2	2.4	5.3	14	30	13	1/2
E	PT240-T2800-I19S	205 147 472 4	2800	3/4 Sq	160-240	118-177	205	8.1	37	1.46	212	8.3	3.3	7.3	15	32	13	1/2
SHUT OFF																		
F	PT010-T5500-S4Q	205 146 227 4	5500	1/4 Hex	5-10	3.7-7.4	205	8.1	21	0.80	178	7.0	0.95	2.1	6	13	8	5/16
G	PT010-L5000-S4Q	205 146 225 4	5000	1/4 Hex	5-10	3.7-7.4	212	8.3	21	0.83	-	-	0.9	1.9	6	13	8	5/16
F	PT014-T6000-S4Q	205 146 228 4	6000	1/4 Hex	8-14	5.9-10	205	8.1	21	0.83	178	7.0	1.0	2.2	6	13	8	5/16
G	PT014-L6000-S4Q	205 146 226 4	6000	1/4 Hex	8-14	5.9-10	212	8.3	21	0.83	-	-	0.9	2.0	6	13	8	5/16
H	PT025-T4500-S10S	205 147 462 4	4500	3/8 Sq	13-25	10-18	177	7.0	26	1.02	192	7.6	1.3	2.9	7	15	8	5/16
I	PT025-L4500-S10S	205 147 463 4	4500	3/8 Sq	13-25	10-18	236	9.3	25	0.98	-	-	1.2	2.5	7	15	8	5/16
H	PT035-T6000-S4Q	205 147 790 4	6000	1/4 Hex	20-36	15-26	175	6.9	26	1.02	192	7.6	1.4	3.0	8	17	8	5/16
H	PT040-T6000-S10S	205 146 229 4	6000	3/8 Sq	22-40	16-29	177	7.0	26	1.02	192	7.6	1.4	3.0	8	17	8	5/16
H	PT070-T4000-S13S	205 146 230 4	4000	1/2 Sq	32-70	24-51	192	7.6	29	1.14	200	7.9	1.8	4.0	10	21	10	3/8
H	PT125-T3500-S13S	205 146 231 4	3500	1/2 Sq	62-125	46-92	201	7.9	34	1.34	211	8.3	2.4	5.3	12	25	10	3/8
J	PT250-T4000-S19S	205 147 464 4	4000	3/4 Sq	125-250	92-185	216	8.5	37	1.46	215	8.5	3.3	7.2	20	42	13	1/2
K	PT450-T3000-S19S	205 147 465 4	3000	3/4 Sq	225-450	166-332	202	8.0	42	1.65	229	9.0	4.3	9.5	22	46	13	1/2

The tool is designed for a working pressure of 6.3 bar 90 PSI.

Pulse Tools - Tool Selection

Non Shut Off range

Bolt Grade at 8.8	Bolt Size				
	M5	M10	M12	M14	M16
PT031-L10000-I10S	20-31 (15-23 ft.lb)				
PT028-T9000-I4Q	17-28 (13-21 ft.lb)				
PT031-T9000-I10S	20-31 (15-23 ft.lb)				
PT052-T7000-I10S		30-52 (22-38 ft.lb)			
PT070-T6000-I13S			50-70 (37-52 ft.lb)		
PT110-T4500-I13S				65-110 (48-81 ft.lb)	
PT160-T3500-I13S					110-160 (81-118 ft.lb)
PT240-T2800-I19S					160-240 (118-177 ft.lb)

Torque: Nm (ft.lb) 10 20 30 40 50 60 70 80 100 150 200 250



Shut Off range

Bolt Grade at 8.8	Bolt Size									
	M5	M6	M8	M10	M12	M14	M16	M18	M20	
PT010-T5500-S4Q	5-10 (4-7 ft.lb)									
PT010-L5000-S4Q	5-10 (4-7) ft.lb									
PT014-T6000-S4Q	8-14 (4-7) ft.lb									
PT014-L6000-S4Q	8-14 (4-7) ft.lb									
PT025-T4500-S10S	13-25 (10-18) ft.lb									
PT025-L4500-S10S	13-25 (10-18) ft.lb									
PT035-T6000-S4Q			20-36 (15-26 ft.lb)							
PT040-T6000-S10S			22-40 (16-29 ft.lb)							
PT070-T4000-S13S				32-70 (24-51 ft.lb)						
PT125-T3500-S13S					62-125 (46-92 ft.lb)					
PT250-T4000-S19S							125-250 (92-185 ft.lb)			
PT450-T3000-S19S									225-450 (166-332 ft.lb)	

Torque: Nm (lb.ft) 5 10 20 30 40 50 60 70 100 150 200 250 300 350 400 450

Accessories

ACCESSORIES INCLUDED

- | | PART NO. |
|--|---------------|
| • Air Hose nipple | |
| • Adjustment screwdriver for all models, | 205 050 137 3 |
| • Except PT031/070/110/PT160/240 | |

Pulse Non shut off

- | | |
|---|---------------|
| • Cover protection for PT031-T9000-I10S | 205 051 325 3 |
| • Cover protection for PT052-T7000-I10S | 205 051 324 3 |
| • Cover protection for PT070-T6000-I13S | 205 051 328 3 |
| • Cover protection for PT110-T4500-I13S | 205 051 329 3 |
| • Cover protection for PT160-T3500-I13S | 205 051 326 3 |
| • Cover protection for PT240-T2800-I19S | 205 051 327 3 |

Pulse Shut off

- | | |
|---|---------------|
| • Cover protection for PT014-T6000-S4Q | 205 051 331 3 |
| • Cover protection for PT025-T4500-S10S | 205 051 328 3 |
| • Cover protection for PT040-T6000-S10S | 205 051 328 3 |
| • Cover protection for PT070-T4000-S13S | 205 051 463 3 |
| • Cover protection for PT125-T3500-S13S | 205 051 464 3 |
| • Cover protection for PT250-T4000-S19S | 205 051 468 3 |
| • Cover protection for PT450-T3000-S19S | 205 050 929 3 |

OPTIONAL ACCESSORIES

- | | PART NO. |
|---|---------------|
| • Reporting kit for PT010-T/L.. / PT014-T/L.. / PT025-T/L.. / PT040-T.. / PT070-T.. / PT125-T.. | 205 011 427 2 |
| • Reporting kit for PT250-T.. / PT450-T.. | 205 011 428 2 |
| • Suspension bail for PT031L/010/014/025L | 451463 |
| • Suspension bail for PT010/014/031/052 | 451393 |
| • Suspension bail for PT025/040/070/110/125T | 459843 |
| • Suspension bail for PT160/240/250/450T | 205 050 906 3 |
| • Exhaust hose for PT031L | 452243 |
| • Exhaust hose for PT010/014/025L | 459813 |



Measurement System

Delta 1D / Delta 6D / Delta 7D

The generation of Delta analyzer is the compact portable solution to monitor all types of production tools in just 500g. Combined with standard Desoutter DRT or DST transducers it's capable of calibrating pulse tools, electric nutrunners or torque wrenches. Divided into three models for Torque measurement only (DELTA 1D), Torque & Angle (Delta 6D) and capable of residual torque check with DWTA wrench (Delta 7D)

MAIN FEATURES

- Display: Large color screen shows clear test results, Torque&Angle curves. Real time statistics, Tools description and Routes
- Connectivity: Ethernet and USB port for Delta QC software communication and RS232 for CVI II and CVI3 calibration or barcode reader
- Power: Li-Ion high capacity battery of 16 hours of autonomy or external power supply.



Measurement Unit

Delta 1D / Delta 6D / Delta 7D



MAIN FEATURES	DELTA 1D	DELTA 6D	DELTA 7D
Transducer			
Connection to DRT4, DRT5, DST	✓	✓	✓
Connection to DWT, DWTA			✓
Angle measurement		✓	✓
On board functionality			
Wrench test	✓	✓	✓
Nutrunner test	✓	✓	✓
Pulse test	✓	✓	✓
Tools	1	1000	1000
Pset		1000	1000
Integrated Statistic	Min, Max Avg	Cm, Cmk (ISO, NF and CNOMO standards)	Cm, Cmk (ISO, NF and CNOMO standards) + SPC
Results	1000	5000	5000
Curve	10	10	10
CVI autocalibration		✓	✓
External Barcode connectivity		✓	✓

MODEL	PART NUMBER	POWER REQUIREMENTS		DEPTH		DIMENSIONS		HEIGHT		WEIGHT	
		BATTERY LIFE	CHARGER	mm	in.	mm	in.	mm	in.	kg	lb
Delta 1D	615 935 101 0	16	110/240	45	1.77	95	3.74	192	7.6	0.5	1.1
Delta 6D	615 935 102 0	16	110/240	45	1.77	95	3.74	192	7.6	0.5	1.1
Delta 7D	615 935 103 0	16	110/240	45	1.77	95	3.74	192	7.6	0.5	1.1

ACCESSORIES INCLUDED

	PART NO.
• Delta Battery	615 936 142 0
• Universal Power Supplier	615 936 143 0



OPTIONAL ACCESSORIES

ITEM	PART NO.
1 Rubber Protection	615 936 141 0
• CMD & ST 4000 Adapter	615 917 671 0
• CMD 5000 Adapter	615 917 672 0
• RS232 Adapter	615 917 670 0
• GSE 2500 Adapter*	615 917 674 0
• GSE 8500T Adapter*	615 917 675 0
• GSE 8500T/A Adapter*	615 917 676 0
2 Delta Demo Case (Empty)	615 936 140 0
• Delta QC Licensed - 1 user	615 927 651 0
• Delta QC Licensed - 5 user	615 927 652 0
• Delta QC Advanced 1 user	615 927 653 0
• Delta QC Advanced 5 user	615 927 654 0

*Check with your local Desoutter representative regarding availability on your market.



Torque Wrench

Digital Wrench Vision for Torque & Angle

The digital wrench integrates in a unique device a flexible solution for both production and quality strategy in tightening. DWT provides high accuracy solution for torque controlled joints tightening, while the DWTA introduces a digital angle measurement for very critical applications. DWTA also introduces a quality strategy with angle measurement and traceability for a perfect quality audit

Non Length
Dependent
Transducer thanks
to double bridge
strain gauge.
To guarantee a tightening
result independent
from operator hand position

1% of torque accuracy
along a wide range

USB Port for DELTA QC
free software
communication for
programming 10
predefined PSet
or to Export result
in XLS report

Standard
interchangeable
heads

See page 116
for wrench
accessories

Ergonomic
keyboard
to recall
the predefined
PSet

Backlight RGB
colour display
for operator
guidance plus
acoustic buzzer

Quick
exchange
battery pack

3 x Standard
or Rechargeable
AA Batteries

Optional gyroscope
for angle measurement
(DWTA VISION)

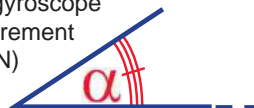

Torque Wrench

Digital Wrench Vision for Torque & Angle

MAIN FEATURES

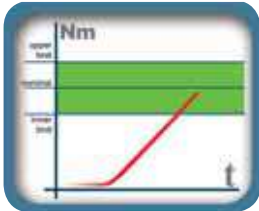

Tightening within torque limits

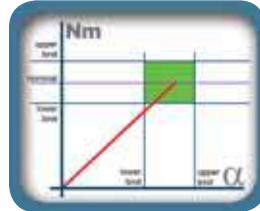

Tightening within torque and angle limits (tightening to a window)

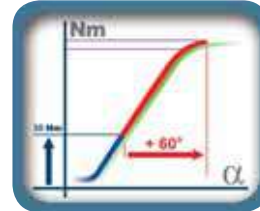

Tightening with torque and additional angle rotation (torque + angle)

PRODUCTION STRATEGIES

- Accuracy for critical tightenings
- Production data traceability
- Wide torque range to replace click wrenches
- Repair station fastening capability
- Difficult access joints tightening
- Re-hit detection
- Low calibration cost
- Back up tool

QUALITY STRATEGIES

- Quality audit checks for already tightened joint
- Export data for quality & statistic analysis
- Predefined angle rotation for operator independence
- Perfect for fast & accurate pulse tools setting



TECHNICAL SPECIFICATION

10 predefined Pset	Pset with T/A limits defined by Delta QC Software
USB Communication	Bi-directional communication to Delta QC Software
Batch Count	Up to 99
Results	1000
Production Strategies	Torque/Time, Torque & Angle, Torque + Angle
RGB Display	Red Green or Blue backlight
Quality Audit Strategy	Peak Torque, Torque plus Angle CW/CCW Tightenigs
Buzzer	
Torque Accuracy	1% of torque reading +/- 1 digit
Multi-units	N.m, N.cm, Kgf.cm, Kgf.m, Ozf.in, Lbf.in, Lbf.ft
Angle Accuracy	1% of angle reading +/- 1 digit
Autoswitch	Off
Battery	3 x AA Standard or Rechargeable
Languages	French, English, Spanish, Italian, Deutsch, Portuguese
Power Autonomy	up to 4 hours
Software	Free Delta QC software to define Pset and downloads results

Delivered in plastic box

MODEL	PART NUMBER	RANGE		ANGLE	DRIVE		INCLUDED RACHET	LENGTH		WEIGHT	
		Nm	ft. lb		mm	in.		mm	in.	kg	lb
DWT Vision 30	615 165 755 0	3 - 30	2.21 - 22.1		9x12	0.35x0.47	3/8	382	15.04	0.8	1.76
DWT Vision 150	615 165 756 0	15 - 150	11.1 - 111		14x18	0.55x0.71	1/2	398	15.67	0.9	1.98
DWT Vision 800	615 165 758 0	80 - 800	59 - 590		ø 28	1.0	1	1358	53.46	5.0	11.02
DWTA Vision 30	615 165 765 0	3 - 30	2.21 - 22.1	✓	9x12	0.35x0.47	3/8	382	15.0	0.8	1.76
DWTA Vision 150	615 165 766 0	15 - 150	11.1 - 111	✓	14x18	0.55x0.71	1/2	398	15.67	0.9	1.98
DWTA Vision 800	615 165 768 0	80 - 800	59 - 590	✓	ø 28	1.0	1	1358	53.46	5.0	11.02

Torque Wrench

Digital Wrench for Torque & Angle

In combination with Delta 7D, the new torque and angle wrench for:

- All tightening strategies of DWTA Vision +
- Residual torque check at predefined angle rotation
- Joint analysis with Yield point detection
- Non Length Dependent Transducer thanks to double bridge strain gauge. To guarantee a tightening result independent from operator hand position. 1% of torque accuracy along a wide range
- Military connector for standard transducer cable.
- Gyroscope for angle measurement

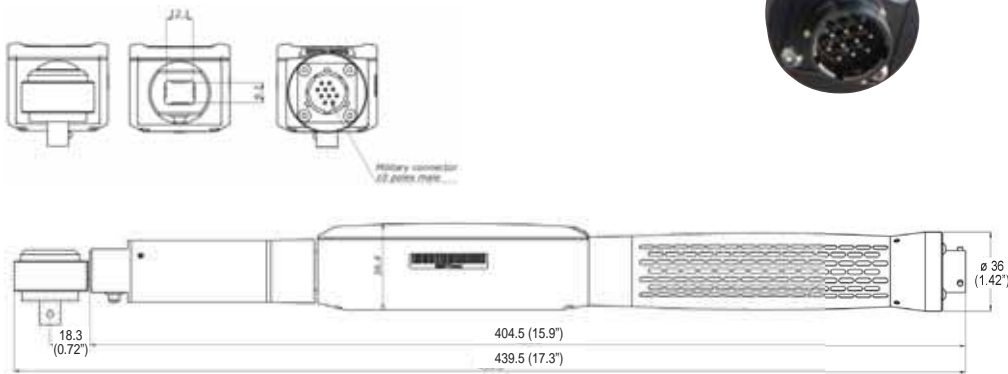

Delivered in plastic box

MODEL	PART NUMBER	TORQUE RANGE		DRIVE		INCLUDED RACHET	LENGTH		WEIGHT	
		Nm	ft. lb	mm	in.		in.	mm	in.	kg
DWTA 30	615 165 760 0	3 - 30	2.2 - 22	9x12	0.35x0.47	Sq. 3/8	404.5	15.93	0.8	1.76
DWTA 150	615 165 761 0	15 - 150	11.1 - 111	14x18	0.55x0.71	Sq. 1/2	412.5	16.24	0.9	1.98
DWTA 800	615 165 763 0	80 - 800	59 - 590	Ø 28	1.01	Sq. 1	1404	55.28	5.0	11.0

DWTA ACCESSORIES

PIC REF	MODEL	PART NUMBER	DRIVE		DIMENSIONS				WEIGHT	
			mm	in	A	B	H	L	kg	lb

A	Open End														
	A	Open End 13mm	615 397 061 0	9x12	0.03x0.47	13	0.51	30	1.18	7	0.28	17.5	0.69	0.048	0.106
	A	Open End 17mm	615 397 065 0	9x12	0.03x0.47	17	0.67	38	1.50	8.5	0.33	17.5	0.69	0.060	0.132
	A	Open End 22mm/0.87"	615 397 139 0	14x18	0.55x0.71	22	0.87	50	1.97	11	0.43	25	0.98	0.165	0.363
B	A	Open End 24mm/0.94"	615 397 140 0	14x18	0.55x0.71	24	0.94	53	2.09	12	0.47	25	0.98	0.167	0.368
	Ring End														
	B	Ring End 17mm/0.67"	615 397 087 0	9x12	0.03x0.47	17	0.67	27.2	1.07	13	0.51	17.5	0.69	0.059	0.130
	B	Ring End 22mm/0.87"	615 397 091 0	9x12	0.03x0.47	22	0.87	34.5	1.36	15	0.59	17.5	0.69	0.074	0.163
C	B	Ring End 22mm/0.87"	615 397 181 0	14x26	0.55x1.02	22	0.87	34.5	1.36	15	0.59	25	0.98	0.145	0.319
	B	Ring End 24mm/0.94"	615 397 182 0	14x26	0.55x1.06	24	0.94	37.5	1.48	15	0.59	25	0.98	0.153	0.337
D	Flared End														
	C	Flared End 22mm	615 397 113 0	9x12	0.03x0.47	22	0.87	39	1.54	15	0.59	19	0.75	0.092	0.202
D	Reversible Ratchet														
	D	Reversible Ratchet 1/4"	615 397 125 0	9x12	0.03x0.47	1/4		22	0.87	14.5	0.57	17.5	0.69	0.062	0.137
	D	Reversible Ratchet 3/8"	615 397 126 0	9x12	0.03x0.47	3/8		22	0.87	14.5	0.57	17.5	0.69	0.062	0.137
	D	Reversible Ratchet 1/2"	615 397 127 0	9x12	0.03x0.47	1/2		22	0.87	14.5	0.57	17.5	0.69	0.062	0.137
	D	Reversible Ratchet 1/2"	615 397 200 0	14x18	0.55x0.71	1/2		50	1.97	30.7	1.21	25	0.98	0.467	1.022
	D	Reversible Ratchet 3/4"	615 397 201 0	14x18	0.55x0.71	3/4		50	1.97	30.7	1.21	25	0.98	0.467	1.022
D	Reversible Ratchet 1"	615 397 204 0	Ø 28		1		50	1.97	30.7	1.21	25	0.98	0.467	1.022	

Digital Torque Tester

Alpha

MAIN FEATURES

- Alpha D Series is designed to monitor and collect torque check results from screwdrivers, torque wrenches or click wrenches
- Ideal to tune the tools thanks to real time statistics on colour display and high capacity torque results storage
- Traceability with included software result acquisition with time stamp, including PDF or XLS reports
- Three models with embedded transducer to cover torque range from 0,1 to 16 Nm. All models are provided with two included joint simulators to test nutrunner according to different joint stiffness condition

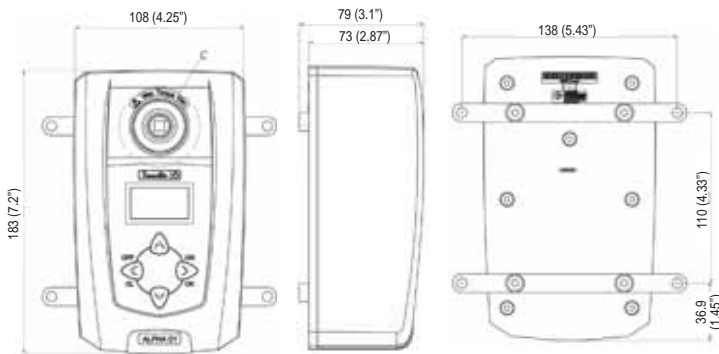

TECHNICAL SPECIFICATION

Torque Transducer	Embedded
Torque Accuracy	1% of readings
Tool Testing	Torque Wrench, Nutrunner or Pulse Tools
Statistic	Min, Max, Average, Standard Deviation
Results Storage	1000 + 10 curves with Delta QC Licensed
Multi-units	N.m, Kg.m, Kg.cm, Oz.in, Lb.in, Lb.ft, N.cm
Display	Red, Green, Blue backlight
Power Supply	External power supply
Languages	French, English, Spanish, Italian, Deutsch, Portuguese
Software	Free Delta QC Software to export by USB result



Delivered in plastic box

MODEL	PART NUMBER	POWER CHARGER	TORQUE RANGE		DEPTH		DIMENSIONS WIDTH		HEIGHT		WEIGHT	
			Nm	in. lb	mm	in.	mm	in.	mm	in.	kg	lb
ALPHA D1	615 935 104 0	110/240	0.1 - 1	0.88 - 8.85	106	4.17	180	7.09	70	2.76	0.95	2.1
ALPHA D5	615 935 105 0	110/240	0.5 - 5	4.42 - 44.2	106	4.17	180	7.09	70	2.76	0.95	2.1
ALPHA D16	615 935 106 0	110/240	1.6 - 16	14.1 - 141.6	106	4.17	180	7.09	70	2.76	0.95	2.1

Digital Rotary Transducers

Torque

Benefits of using Desoutter digital transducers:

- Automatic recognition thanks to internal memory chip storing main data values eliminating any setting mistakes and time losses
- High reliability due to immunity from external noise thanks to digital communication
- Communication to data analyzer not sensitive to the cable length
- Long life durability thanks to industrial design from transducer to housing

The Rotary Torque Transducer DRT4 is designed to measure the torque output of any non-impact assembly tool. The transducer is suitable for use with impulse type assembly tools brushes with minimal maintenance requirements



MAIN FEATURES

- Torque range from 0.15 to 5000 Nm (0.11 to 3685 ft.lb)
- Strain gauges transducer
 - sensitivity 2mV/V
 - accuracy +/-0.35% full scale
- Built-in smart chip memory with calibration features:
 - *type of transducer – sensitivity*
 - *nominal load – serial number*

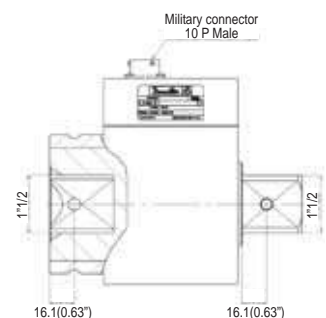
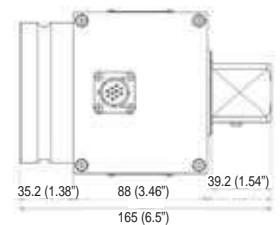
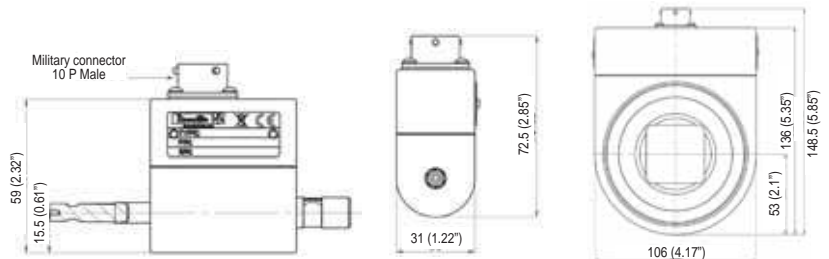

TORQUE TRANSDUCERS DRT4

MODEL	PART NUMBER	TORQUE RANGE		OUTPUT
		Nm	ft. lb	in.
DRT 4 H 2	615 165 209 0	0.15-2	0.11-1.5	Hex 1/4
DRT 4 H 5	615 165 210 0	0.3-5	0.22-3.7	Hex 1/4
DRT 4 H 20	615 165 211 0	1.5-20	1.11-14.7	Hex 1/4
DRT 4 Sq 20	615 165 212 0	1.5-20	1.11-14.7	Sq 1/4
DRT 4 Sq 25	615 165 213 0	1.8-25	1.33-18.4	Sq 3/8
DRT 4 Sq 75	615 165 214 0	5.0-75	3.69-55.3	Sq 3/8
DRT 4 Sq 180	615 165 215 0	12.0-180	8.85-132	Sq 1/2
DRT 4 Sq 500	615 165 216 0	35.0-500	25.8-368	Sq 3/4
DRT 4 Sq 1400	615 165 217 0	95.0-1400	70.0-1032	Sq 1
DRT 4 Sq 3000	615 165 536 0	200-3000	147-2211	Sq 1-1/2
DRT 4 Sq 5000	615 165 540 0	350-5000	258-3685	Sq 1-1/2

Digital Rotary Transducers

Torque & Angle

An alternative version DRT 5 is available with an angle measurement encoder which allows with a DELTA 6D or DELTA 7D, the measurement of the angle of rotation in addition to torque

MAIN FEATURES

- Torque range from 0.15 to 1400 Nm (0.11 to 1032 ft.lb)
- Angle counting system 0.5° resolution
- Strain gauges transducer
 - sensitivity 2mV/V.
 - accuracy +/-0.35% full scale.
- Built-in smart chip memory with calibration features:
 - *type of transducer – sensitivity*
 - *nominal load – serial number*



TORQUE & ANGLE TRANSDUCERS DRT5

MODEL	PART NUMBER	TORQUE RANGE		OUTPUT
		Nm	ft. lb	in.
DRT 5 H 2	615 165 218 0	0.15-2	0.11-1.5	Hex 1/4
DRT 5 H 5	615 165 219 0	0.3-5	0.22-3.7	Hex 1/4
DRT 5 H 20	615 165 220 0	1.5-20	1.11-14.7	Hex 1/4
DRT 5 Sq 20	615 165 221 0	1.5-20	1.11-14.7	Sq 1/4
DRT 5 Sq 25	615 165 222 0	1.8-25	1.33-18.4	Sq 3/8
DRT 5 Sq 75	615 165 223 0	5.0-75	3.69-55.3	Sq 3/8
DRT 5 Sq 180	615 165 224 0	12.0-180	8.85-132	Sq 1/2
DRT 5 Sq 500	615 165 225 0	35.0-500	25.8-368	Sq 3/4
DRT 5 Sq 1400	615 165 226 0	95.0-1400	70.0-1032	Sq 1

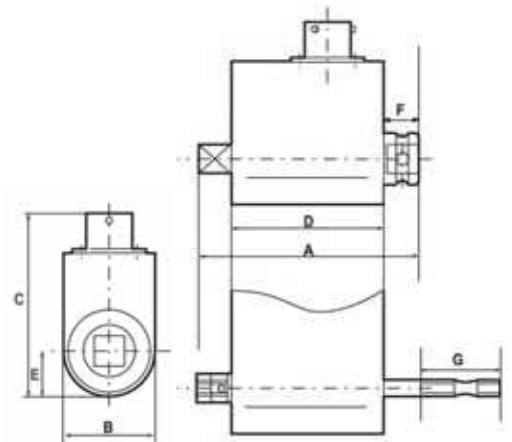

Same size for torque or torque & angle transducer

OUTPUT	A		B		C		D		E		F		G	
	in.	mm	in.	mm	in.	mm	in.	mm	in.	mm	in.	mm	in.	
Hex 1/4	116.0	4.56	31.0	1.22	71.9	2.83	56.0	2.20	15.5	0.61	39.0	1.53	25.5	1
Sq 1/4	71.5	2.81	31.0	1.22	71.9	2.83	56.0	2.20	15.5	0.61	6.0	0.24		
Sq 3/8	77.0	3.03	31.0	1.22	71.9	2.83	56.0	2.20	15.5	0.61	8.0	0.31		
Sq 1/2	87.0	3.42	42.0	1.65	82.9	3.26	58.0	2.28	21.0	0.83	12.0	0.47		
Sq 3/4	106.0	4.17	52.0	2.05	92.9	3.66	66.0	2.60	26.0	1.02	21.0	0.83		
Sq 1	125.0	4.92	65.0	2.56	104.9	4.13	73.0	2.87	32.5	1.28	29.0	1.14		
Sq 1-1/2	165.0	6.50	106	4.17	148.5	5.85	88.0	3.46	53.0	2.09	35.2	1.39		

DST - Digital Static Transducers

Designed for testing wrenches, click wrenches or for tightening tools where rotary action is not desired during measurement
In the case of a Shut-Off tool test a joint simulator as an accessory is required

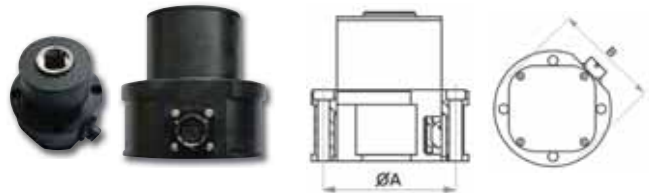

MODEL	PART NUMBER	TORQUE RANGE		SQUARE DRIVE	DIMENSIONS				WEIGHT	
		Nm	lb		Ø A		Ø B		kg	lb
				in	mm	in	mm	in		
DST 0.5 Nm - 13	615 165 537 0	0.05-0.5	0.04-0.4	1/2	81	3.19	91	3.58	2.2	5.1
DST 2 Nm - 13	615 165 532 0	0.2-2	0.15-1.5	1/2	81	3.19	91	3.58	2.2	5.1
DST 5 Nm - 13	615 165 533 0	0.5-5	0.37-3.7	1/2	81	3.19	91	3.58	2.3	5.1
DST 10 Nm - 20	615 165 534 0	1-10	0.74-7.4	3/4	86	3.38	93	3.66	3.1	6.8
DST 30 Nm - 20	615 165 535 0	3-30	2.21-22	3/4	89	3.50	96	3.78	3.4	7.5
DST 80 Nm - 25	615 165 538 0	8-80	5.89-59	1	108	4.25	116	4.57	5.8	12.8
DST 200 Nm - 25	615 165 539 0	20-200	14.7-147	1	108	4.25	116	4.57	5.8	12.8
DST 500 Nm - 32	615 165 541 0	50-500	36.8-368	1-1/4	133	5.24	144	5.67	11.8	26.0
DST 1000 Nm - 32	615 165 542 0	100-1000	73.7-737	1-1/4	133	5.24	144	5.67	11.9	26.2
DST 2000 Nm - 32	615 165 543 0	200-2000	147.4-1474	1-1/4	133	5.24	144	5.67	12.0	26.4

DSA - DELTA STATIC TRANSDUCERS ACCESSORIES

MODEL	PART NUMBER	MODEL	PART NUMBER
Adaptor SQ 3/4"M - 1/4"F	615 397 205 0	Female 1/4" - Female 1/4"	615 397 210 0
Adaptor SQ 3/4"M - 3/8"F	615 397 206 0	Female 3/8" - Female 3/8"	615 397 211 0
Adaptor SQ 1"M - 1/2"F	615 397 207 0	Female 1/2" - Female 1/2"	615 165 573 0
Adaptor SQ 1-1/4"M - 1/2"F	615 397 208 0	Female 3/4" - Female 3/4"	615 165 576 0
Adaptor SQ 1-1/4"M - 3/4"F	615 397 209 0		
Adaptor SQ 1" F - 1"F	615 936 117 0		

DJS - Digital Joint Simulator



A wide range of mechanical joint simulators are available to reproduce the joint behavior;
installing the joint simulator on a transducer allows you to test a tool in the same real working conditions
Each joint simulator reproduces a specific stiffness as described in its torque/angle characteristics
For each capacity, there are two versions: one reproducing a softer joint and one reproducing a harder joint

MODEL	PART NUMBER	TORQUE RANGE		SQUARE DRIVE		COLOUR		WEIGHT	
		Nm	lb	in	in	INSIDE	OUTSIDE	kg	lb
DJS Soft - 2	615 165 529 0	2	1.5	1/2	Hex1/4	Yellow	Yellow	0.12	0.26
DJS Hard - 2	615 165 530 0	2	1.5	1/2	Hex 1/4	Yellow	Black	0.12	0.26
DJS Soft - 5	615 165 531 0	5	3.7	1/2	Hex 1/4	Green	Yellow	0.12	0.26
DJS Hard - 5	615 165 571 0	5	3.7	1/2	Hex 1/4	Green	Black	0.12	0.26
DJS Soft - 10	615 165 574 0	10	7.4	3/4	1/4	Red	Yellow	0.23	0.51
DJS Hard - 10	615 165 575 0	10	7.4	3/4	3/8	Red	Black	0.41	0.90
DJS Soft - 30	615 165 577 0	30	22	3/4	3/8	Blue	Yellow	0.41	0.90
DJS Hard - 30	615 165 579 0	30	22	3/4	3/8	Blue	Black	0.41	0.90
DJS Soft - 80	615 165 584 0	80	59	1	1/2	Purple	Yellow	0.75	1.65
DJS Hard - 80	615 165 587 0	80	59	1	1/2	Purple	Black	0.75	1.65
DJS Soft - 200	615 165 588 0	200	147	1	1/2	Grey	Yellow	0.75	1.65
DJS Hard - 200	615 165 589 0	200	147	1	1/2	Grey	Black	0.75	1.65
DJS Soft - 500	615 165 590 0	500	369	1-1/4	1/2	Black	Yellow	1.75	3.86
DJS Hard - 500	615 165 591 0	500	369	1-1/4	3/4	Black	Black	3.06	6.74
DJS 1000	615 165 572 0	1000	737	1-1/4	1			3.20	7.05

Measurement Accessories



Preset Torque Adjustable Screwdrivers - For Tightening

MODEL	PART NUMBER	TORQUE RANGE		INCREMENTS		OUTPUT HEX.	LENGTH		WEIGHT	
		metric	imperial	metric	imperial	in.	mm	in.	kg	lb
AS-120	81892	10-120 cNm		1 cNm		1/4 F	168	6.6	0.16	0.35
AS-600	81922	1-6 Nm		0.1 Nm		1/4 F	184	7.2	0.34	0.75
AS-900	81942	1.5-15 Nm		0.1 Nm		1/4 F	184	7.2	0.34	0.75
AS-07	81902		10-120 ozf.in		1 ozf.in	1/4 F	168	6.6	0.16	0.35
AS-50	81932		5-50 lbf.in		1 lbf.in	1/4 F	184	7.2	0.34	0.75
AS-80	81952		40-80 lbf.in		1 lbf.in	1/4 F.	184	7.2	0.34	0.75



Dial Indicating Torque Screwdrivers - For Measuring + Tightening

MODEL	PART NUMBER	TORQUE RANGE		INCREMENTS		OUTPUT HEX.	LENGTH		WEIGHT	
		metric	imperial	metric	imperial	in.	mm	in.	kg	lb
TS-050	81852	0-50 cNm	0.70 ozf.in	2 cNm	5 ozf.in	3/8 F	178	0.7	0.2	0.44
TS-100	81862	0-100 cNm	0.140 ozf.in	5 cNm	10 ozf.in	3/8 F	178	0.7	0.2	0.44
TS-250*	81872	0-250 cNm	0.20 ozf.in	10 cNm	1 ozf.in	1/2 F	250	9.8	0.5	1.10
TS-500*	81882	0-500 cNm	0.40 ozf.in	20 cNm	2 ozf.in	1/2 F	250	9.8	0.5	1.10

* supplied with T bar



Dial Indicating Torque Wrenches - For Measuring + Tightening

MODEL	PART NUMBER	TORQUE RANGE		INCREMENTS		OUTPUT SQUARE	LENGTH		WEIGHT	
		metric	imperial	metric	imperial	in.	mm	in.	kg	lb
TW-4	81962	0.3-4 Nm	3-35 lbf.in	0.1 Nm	1 lbf.in	1/4	255	10	0.52	1.15
TW-13	81972	0.5-13.5 Nm	4-120 lbf.in	0.5 Nm	2 lbf.in	3/8	255	10	0.52	1.15
TW-27	81982	1-27 Nm	1-20 lbf.in	1 Nm	0.5 lbf.in	3/8	255	10	0.52	1.15
TW-80	81992	6-80 Nm	5-60 lbf.in	2 Nm	1 lbf.in	1/2	455	18	1.36	3.0
TW-160	82002	10-160 Nm	6-120 lbf.in	2.5 Nm	2 lbf.in	1/2	535	21	1.36	3.0

Cable

CABLE TYPE	DATA COLLECTOR	FOR TRANSDUCER	LENGTH	PART NUMBER
TYPE				
Digital 10 pins	All types of Delta	All digital transducers	2m (78.7") long	615 917 430 0
Digital 10 pins	All types of Delta	All digital transducers	5m (196.8") long	615 917 433 0
Digital 10 pins	All types of Delta	All digital transducers	2m (78.7") long, spiral	615 917 432 0

Embedded Transducers

Delta Cart

Assembly tools calibration process requires a flexible and versatile solution, high quality performance even in production lines Desoutter Tools is proud to present the Delta Cart, an ergonomic and attractive solution to improve quality in assembly processes

MAIN FEATURES

- Delta Cart offers a wide torque range since it can be configured up to 4 static transducers to cover from 0.2 Nm to 1 000 Nm (0.15 to 738 ft.lb) in a very compact dimensions (510mm width), making the Delta Cart the ideal solution for tool testing in assembly production lines
- Embedded PC equipped with wide 10.4" colour touch screen lets operators to start tool testing in a few seconds and few steps
- Delta Cart includes all adapters, reaction bars and suitable joint simulators Optional ISO RIG for torque wrench to eliminate operator influence during calibration, reducing efforts for high torque range



The Delta Cart is able to follow your tools during the complete life span: by performing capacity test (Cm/Cmk) before tool is introduced into production, or monitoring tool performance during production assembly process by performing Statistic Process Control (SPC) test

- Delta Cart combines high quality heavy duty design on mechanical side with intuitive and user friendly icons based software
- High quality real time curves with zoom feature for analysis
- Local tool and result database to guarantee traceability
- Statistic Result export to USB in Excel format or PDF report
- Delta QC Advanced communication for Tool Scheduler, Route management and result DB

TECHNICAL SPECIFICATION

Torque Wrench, Electric or Pneumatic Nutrunner
Test, Pulse Test
Cm/Cmk - ISO 3534

Local Test Database up to 3000 Tests - Setting: Nominal Min Max Torque, unit of measure, Test Id, Test Description, Transducer number, Timeout setting
Cm/Cmk, min, max, average, sigma

Statistic Control - ISO 8258
Print

X/R Charts for trend control
Report Printing through external laptop and included printing software

Export
Curve

Certificate export through USB Key
UP to 10.000 Curves

Barcode
Configurable for each test

External RS232 for V.I.N. operator code
N.m - gf.cm - Kgf.cm - kgf.m - ozf.in - lbf.in - lbf.ft

Password Management
Languages

Operator - Supervisor - SuperUser
English, French, Italian, German, Spanish, Polish, Swedish

Delta QC Software

Delta QC Licensed

The Delta QC software is the common software platform for all Delta QC measurement equipment. Included features are programming, results and curve viewer ensuring production data traceability. Statistical machine capability tool or SPC are also ensured thanks to local database available in the Advanced version



MODEL	PART NUMBER
Delta QC Licensed 1 User	615 927 651 0
Delta QC Licensed 5 User	615 927 652 0
Delta QC Advanced 1 User	615 927 653 0
Delta QC Advanced 5 User	615 927 654 0

MAIN FUNCTIONS	FREE	LICENSED	ADVANCED
DELTA			
Pset programming		✓	✓
Tool Definition		✓	✓
Route Definition		✓	✓
Transducer Definition		✓	✓
Pset Database		✓	✓
Tool Database		✓	✓
Route Database		✓	✓
Statistic		✓	✓
		(online only)	
Result viewer	✓	✓	✓
Result excel export	✓	✓	✓
Curve viewer		✓	✓
Curve excel, JPEG export		✓	✓
Curve comparison		✓	✓
RESULT Database			✓
Curve Database			✓
Offline statistic			✓

Delta QC Advanced

Advanced version provides a local result database. All results, curves and statistics are available for review, export and reporting in both on line and off line mode

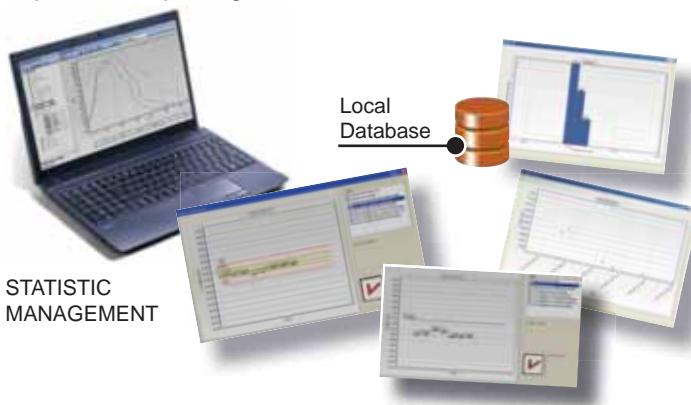

MAIN FUNCTIONS	FREE	LICENSED	ADVANCED
DWTA VISION			
Pset programming	✓	✓	✓
Result viewer	✓	✓	✓
Result excel export	✓	✓	✓
Curve viewer		✓	✓
Result Database			✓
DELTA CART			
Pset programming			✓
Route Definition			✓
Pset Database			✓
Route Database			✓
Result viewer			✓
Result excel export			✓
Result Database			✓
Offline statistic			✓

Delta QC FreeVersion

DWT Vision and Alpha D product range are supplied with the Delta QC software. Without any registration the Delta QC is able to program DWT Vision and Alpha D, download results, export to excel and print

MAIN FUNCTIONS	FREE	LICENSED	ADVANCED
ALPHA D			
Result viewer	✓	✓	✓
Result excel export	✓	✓	✓
Curve viewer		✓	✓



Specific Nutrunners and Spindles



Specific nutrunners

- Flush socket
- Crowfoot
(open or close ended)
- Hold and drive
- Crowfoot Hold and drive
- Insulated
- 2 output shafts
- With multiplier

Specific spindles

- U-Shape
- Specific output shaft
- Second torque transducer

Specific reaction bars

And much more on request !









Multiplus



Options

Suspension (cable balancer or cylinder)
 Transducer holders
 Variable center distance
 (manual, automatic by cylinder or motorized)

PART NO.	DESCRIPTION	
615 396 875 0	Handle start horizontal	
615 396 876 0	Handle start vertical	
615 396 877 0	Handle support cpte	
615 396 878 0	Handle reverse	
615 398 135 0	2 additional buttons kit	
615 398 136 0	1 LED + 1 additional button kit	

Customized machine

Single spindle, Multi spindles, Manual or automatic center distance adjustment



- Standard build components
- Increased customer configuration
- Simplified maintenance
- Proven solution
- Shorter lead time
- Improved ergonomics



HMI



Standard or specific
4", 7" and 8" standard or customized
PC based
Plastic box or stainless steel box



Arms and Torque tubes

PART NO.	DESCRIPTION	TORQUE	SUSPENSION
DSM0020000	Torque tube (aluminium)	0-100 Nm (0-74 ft.lb)	Balancer
DSM0020100			Pneumatic cylinder
DSM0020200	Torque tube (aluminium)	100-250 Nm (74-184 ft.lb)	Balancer
DSM0020300			Pneumatic cylinder
DSM0020400	Torque tube (steel)	250-500 Nm (184-369 ft.lb)	Balancer
DSM0020500			Pneumatic cylinder
DSM0020600	Torque tube (steel)	500-1000 Nm (369-737 ft.lb)	Balancer
DSM0020700			Pneumatic cylinder



ALU + BALANCER

ALU + CYLINDER



STEEL

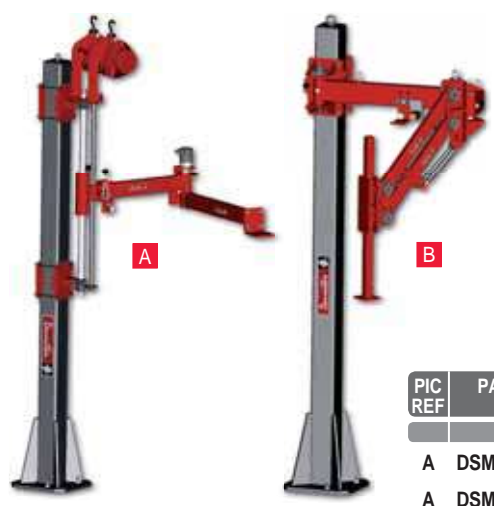

A

B

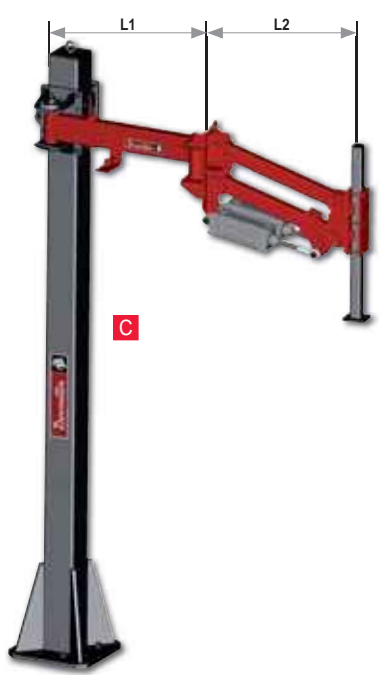

C

PIC REF	PART NO.	DESCRIPTION	TORQUE	SUSPENSION	WORKING POSITION	
					L1xL2	L1xL2
					mm	ft
A	DSM0041000				600x600	1.97x1.97
A	DSM0042000	Reaction arm	150 Nm (111 ft.lb)	Balancer	800x800	2.62x2.62
A	DSM0043000				1000x1000	3.28x3.28
B	DSM0044000				600x600	1.97x1.97
B	DSM0045000	Reaction arm	150 Nm (111 ft.lb)	Gas spring	800x800	2.62x2.62
B	DSM0046000				1000x1000	3.28x3.28
B	DSM0047000				800x800	2.62x2.62
B	DSM0048000	Reaction arm	300 Nm (221 ft.lb)	Gas spring	1200x1200	3.94x3.94
B	DSM0049000				1500x1500	4.92x4.92
B	DSM0050000				800x800	2.62x2.62
C	DSM0051000	Reaction arm	300 Nm (221 ft.lb)	Cylinder	1200x1200	3.94x3.94
C	DSM0052000				1500x1500	4.92x4.92
C	DSM0053000				800x800	2.62x2.62
C	DSM0054000	Reaction arm	600 Nm (442 ft.lb)	Cylinder	1200x1200	3.94x3.94
C	DSM0055000				1500x1500	4.92x4.92
C	DSM0056000				1000x1000	3.28x3.28
C	DSM0057000	Reaction arm	1000 Nm (737 ft.lb)	Cylinder	1500x1500	4.92x4.92
C	DSM0058000				2000x2000	6.56x6.56
C	DSM0059000	Reaction arm	300 Nm (221 ft.lb)	Aluminium version Cylinder	1500x1500	4.92x4.92
C	DSM0060000	Reaction arm	2000 Nm (1474 ft.lb)	Steel version Cylinder	1500x1500	4.92x4.92

Accessories

Tool holders

Torque tube options

- Controller and accessories stand
- Parking position sensor
- Encoder
- Pneumatic suspension
- Balancers suspension
- Trolley for rails mounting

Arms options

- Controller and accessories stand
- Parking position sensor
- Encoders (possible on each axis)
- Rotating pillar
- Brakes

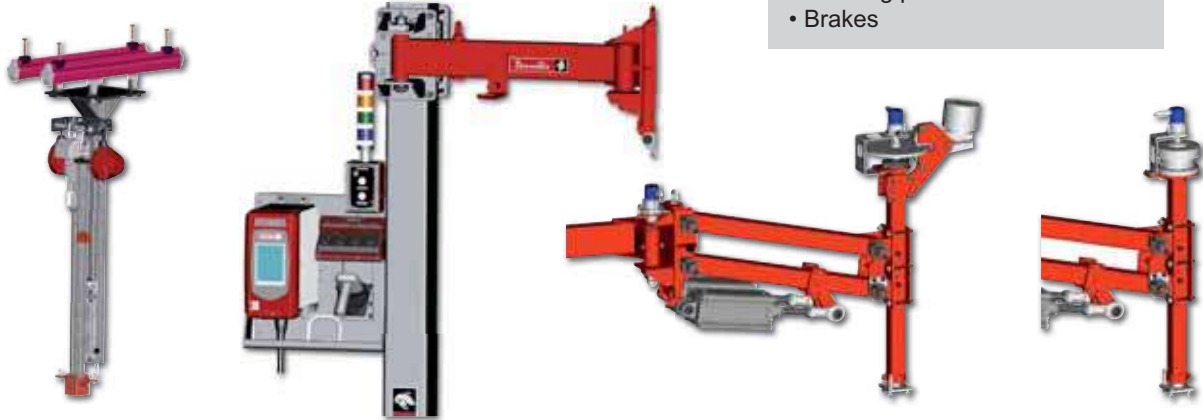

MODEL	PART NO.	Fixed tool holder	X-Rotating tool holder	Indexed X-rotating tool holder
EAD 20-1300	615 165 606 0	DSM0001100	DSM0002100	DSM0003100
EAD 32-900	615 165 607 0	DSM0001100	DSM0002100	DSM0003100
EAD 50-900	615 165 609 0	DSM0001200	DSM0002100	DSM0003120
EAD 70-800	615 165 611 0	DSM0001300	DSM0002200	DSM0003200
EAD 80-650	615 165 612 0	DSM0001400	DSM0002300	DSM0003300
EAD 105-500	615 165 613 0	DSM0001400	DSM0002300	DSM0003300
EAD 160-430	615 165 681 0	DSM0001500	DSM0002400	DSM0003400
EAD 200-370	615 165 682 0	DSM0001600	DSM0002500	DSM0003500
EAD 280-260	615 165 683 0	DSM0001600	DSM0002500	DSM0003500
EAD 280-370	615 165 684 0	DSM0001700	DSM0002600	DSM0003600
EAD 440-250	615 165 685 0	DSM0001800	DSM0002700	DSM0003700
EAD 660-160	615 165 686 0	DSM0001900	DSM0002800	DSM0003800
EID 25-1200	615 165 614 0	DSM0008100	NA	NA
EID 32-900	615 165 615 0	DSM0008200	NA	NA
EID 44-1200	615 165 616 0	DSM0008300	NA	NA
EID 65-900	615 165 617 0	DSM0008400	NA	NA
EID 75-800	615 165 618 0	DSM0008500	NA	NA
EID 120-660	615 165 677 0	DSM0008600	NA	NA
EID 170-670	615 165 678 0	DSM0008700	NA	NA
EID 270-410	615 165 679 0	DSM0008800	NA	NA
EID 360-300	615 165 680 0	DSM0008900	NA	NA



Z-Rotating tool holder	Indexed Z-rotating tool holder
DSM0004000	DSM0005000
	
Y-Rotating tool holder	Indexed Y-rotating tool holder
DSM0006000	DSM0007000
	

Special Solutions

Controller stand

1 Controller CVI3 and accessories or 2 controllers
Floor mounted or Hanged



PIC REF	PART NO.	DESCRIPTION	COMMENT
A	DSM0011100	Stand for Controller	2 CVI3 vision/function controller stand from ground
B	DSM0011150	Stand for Controller	1 CVI3 vision/function controller + accessories stand from ground
C	DSM0011200	Stand for Controller	2 CVI3 vision/function controller stand from ceiling
D	DSM0011250	Stand for Controller	1 CVI3 vision/function controller + accessories stand from ceiling
-	DSM0011300	Stand for Controller	Twin CVI3

Special functions:

Trombons (vertical and horizontal)

Special gear boxes simple or with Hold and Drive
Special gear boxes with 2 spindles



Other Special Solutions



Trolleys
Arms on trolley

1 spindle with electromagnet and reaction pin
with 2 center distances

Special multi spindle with orientation, center distance
adjustment, suspension with brake, ...

And much more on request !



Screwfeeder Solutions - Handheld & Fixtured units

HST - Telescopic handheld unit

- High Productivity
- Light and Compact
- Easy to use/ Easy to maintain
- Push Start System



HSF - Advanced handheld unit

- High performance rate
- Protuding system (retention in jaws)
- Easy to use/ Easy to maintain
- Optional Advanced Nozzle with swivelling arm



SEL/SRL – Stationary units

- Simple & flexible
- Dedicated solution robot with SRL / MTB
- Easy to integrate / Easy to maintain
- SEL with 2 strokes / SRL with 1 stroke



	HST	HSF	SEL	SRL
Type	Hand held	Hand held	Fixture	Fixture
Start	Push	Lever	Remote	Remote
Stroke	up to 78mm	up to 110mm	up to 80/180mm	up to 180mm
Torque	up to 10Nm	up to 15Nm	up to 100Nm	up to 100Nm
Pneumatic & Electric Tools	✓	✓	✓	✓
Screw retention in jaws	✗	✓	✗	✗
Recommended installation	Balancer or Arm	Arm	Fixture Installation	Fixture Installation Robot

ZSE – Modular Bowls feeders



Our bowl units have been strongly designed for a quick and easy access to the critical elements, improving effective efficiency and reducing maintenance time

Accessories

Sensors



Screw present sensor
Screw feeding detection on hose



Home sensor
Home position detection of cylinders on SEL/SRL

Depth sensor
Depth tightening detection when required by application



Escapement sensors
Control/Secure escapement mechanism

Bowl options



Control level
Detect and inform when the bowl is empty

Hopper
increase your bowl capacity

Linear arms



Fixtured electric spindles ERF-ECF

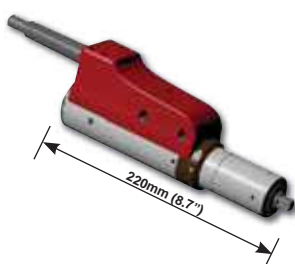

For your assembly applications, Desoutter offers a range of (very short) fixtured electric spindles, transducerized or current controlled and top or in-line cables

CVI II Range

MODEL	PART NUMBER
ERF3L	615 165 286 0
ERF5L	615 165 287 0
ERF10L	615 165 288 0
ERF20L	615 165 289 0
ERF20S	615 165 290 0
ERF30S	615 165 291 0

CVIC Range

MODEL	PART NUMBER
ECF3L	615 165 292 0
ECF5L	615 165 293 0
ECF10L	615 165 294 0
ECF20L	615 165 295 0
ECF20S	615 165 296 0
ECF30S	615 165 297 0

For further information about the technical data see pages 45 and 59



Optimized workstations

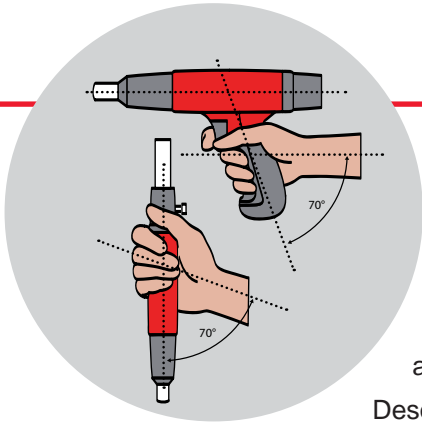

Fig. 1
Holding tools in an ergonomically neutral position

Ergonomics deals with the interactions between operators and their work equipment, work environment and work process

Ergonomically designed work systems enhance safety, effectiveness and efficiency, improve human working and living conditions, and counteract adverse effects on human health and performance

Desoutter has been developing products to improve the comfort of use and counter balance some of the below situations:

1. Hand position on the tool: based on application a straight or pistol grip tool is suggested (Fig. 1)
2. Tool position in the workspace: easy to reach and at the right height to minimize the unnecessary movement of the operator (Fig. 2 and 3)
3. Forces exerted: pulling force, torque reaction and the repetitiveness of these forces (Fig. 2 and 3)

The potential benefits of using Desoutter ergonomic accessories together with tools as described in this brochure are:

- Reduce repetitive stress injuries (RSI)
- Reduced operator fatigue
- Greater productivity
- Improved quality
- Reduced handling time
- Greater operator satisfaction
- Lower recruitment costs

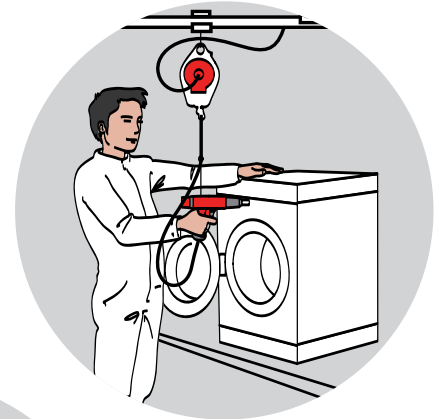

Fig. 2
Desoutter balancer

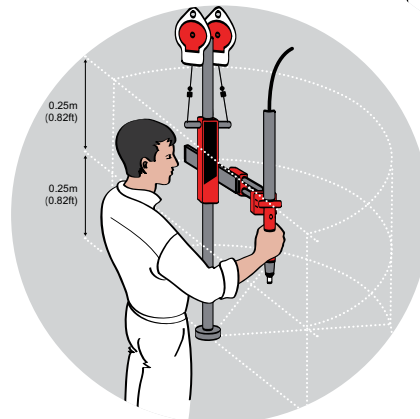
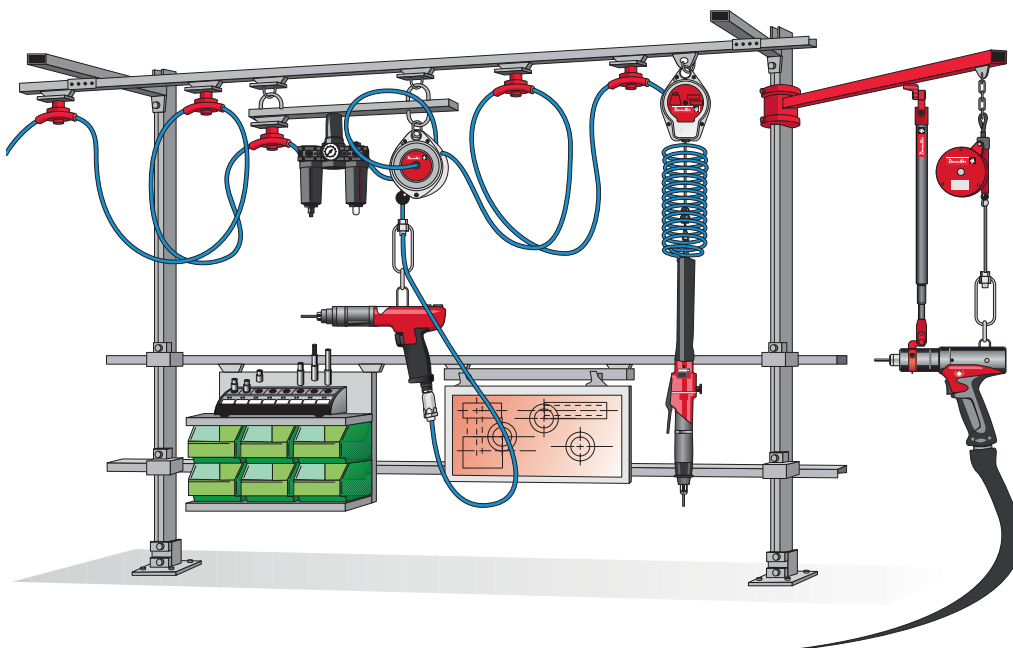
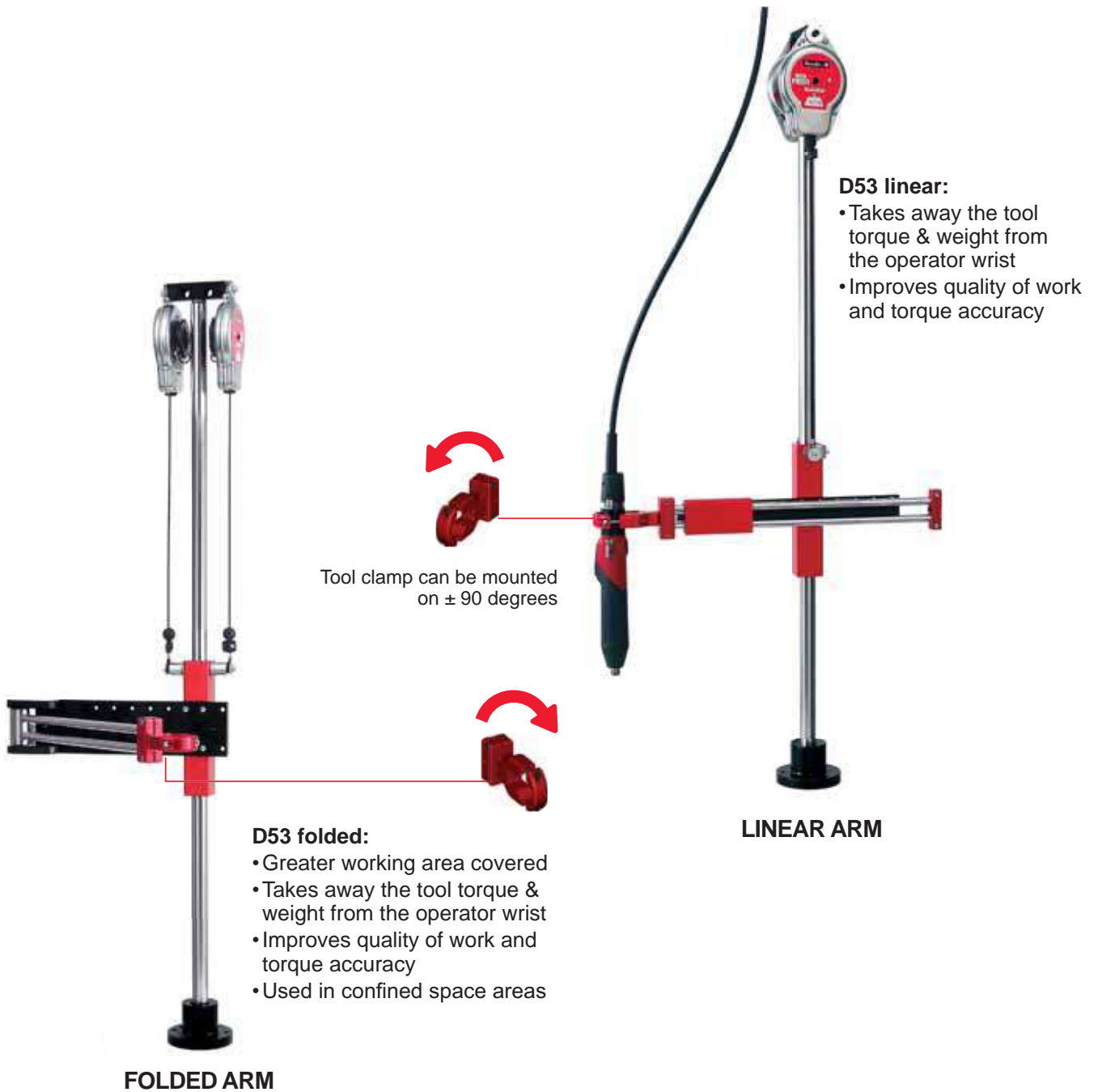

Fig.3
Desoutter torque reaction arm



Linear and Folded torque reaction arms



For full tool clamp program, please see details on page 140

MODEL	PART NUMBER	MAXIMUM TORQUE		MAXIMUM TOOL WEIGHT		ARM EQUIPPED WITH	TOOL CLAMP DIAMETER (INCLUDED WITH THE ARM)	
		Nm	ft. lb.	kg	lb.		mm	in.
LINEAR ARM								
D53-5*	615 810 700 0	5	3.7	0.8	1.8	1 x 5DU	28.5-41	1.12-1.62
D53-12*	615 810 701 0	12	8.8	1.5	3.3	2 x 5DU	28.5-41	1.12-1.62
D53-25*	615 810 702 0	25	18.4	2.5	5.5	2 x 5DU	28.5-41	1.12-1.62
D53-25X Extended reach*	615 810 703 0	25	18.4	2.2	4.8	2 x 5DU	28.5-41	1.12-1.62
D53-50	615 810 704 0	50	36.8	5.0	11.0	2 x 15D	To order separately	
D53-100	615 810 705 0	100	73.7	6.0	13.2	2 x 22D	To order separately	
FOLDED ARM								
D53-5S*	615 810 706 0	5	3.7	0.8	1.8	1 x 5DU	28.5-41	1.12-1.62
D53-12S*	615 810 707 0	12	8.8	1.5	3.3	2 x 5DU	28.5-41	1.12-1.62
D53-25S*	615 810 708 0	25	18.4	2.5	5.5	2 x 5DU	28.5-41	1.12-1.62
D53-50S	615 810 709 0	50	36.8	5.0	11.0	2 x 15D	To order separately	
D53-100S	615 810 710 0	100	73.7	6.0	13.2	2 x 22D	To order separately	

(*) Universal D53 tool clamp included

D53 - Dimensions

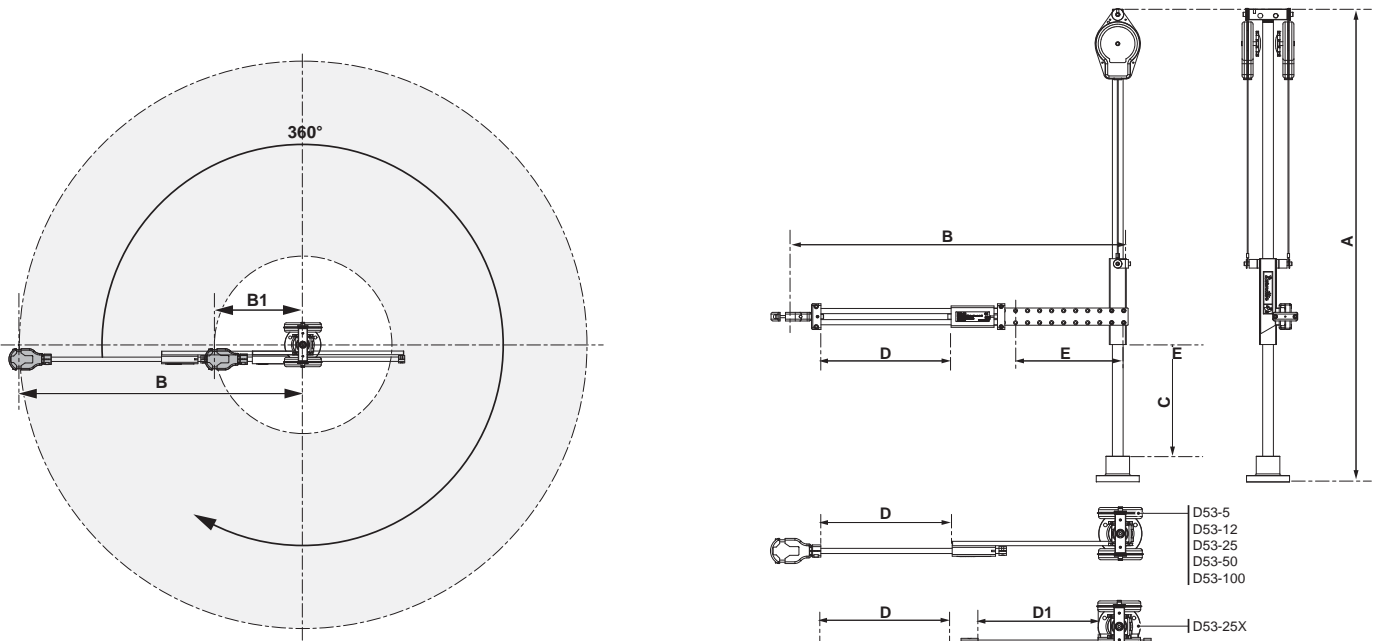

D53 linear working area product specification

MODEL	PART NUMBER	MAXIMUM TORQUE		HEIGHT A		WIDTH				VERTICAL STROKE C		HONRIZONTAL STROKE				FIXED STROKE E		TOOL WEIGHT MAX	
		Nm	ft. lb	mm	in	MAXI-B	MINI-B	mm	in	mm	in	mm	in	mm	in	mm	in.	kg	lb
D53-5	615 810 700 0	5	3.7	732	28.8	592*	23.3*	220*	8.7*	310	12.2	205	8.1	-	168	6.6	0.8	1.76	
D53-12	615 810 701 0	12	8.9	888	35.0	710*	28*	260*	10.2*	465	18.3	255	10.0	-	196	7.7	1.5	3.3	
D53-25	615 810 702 0	25	18.4	1132	44.6	779*	30.7*	231*	9.1*	615	24.2	290	11.4	-	252	9.9	2.5	5.5	
D53-25X	615 810 703 0	25	18.4	1132	44.6	794*	31.2*	230*	9.0*	615	24.2	290	11.4	275	10.8	-	2.2	4.85	
D53-50	615 810 704 0	50	36.9	1147	45.2	888*	35.0*	267**	10.5**	515	20.3	355	14.0	-	266	10.5	5.0	11.0	
D53-100	615 810 705 0	100	73.8	1147	45.2	916*	36.0*	255**	10.0**	515	20.3	395	15.6	-	266	10.5	6.0	13.2	

(*) With clamp - (**) Without clamp

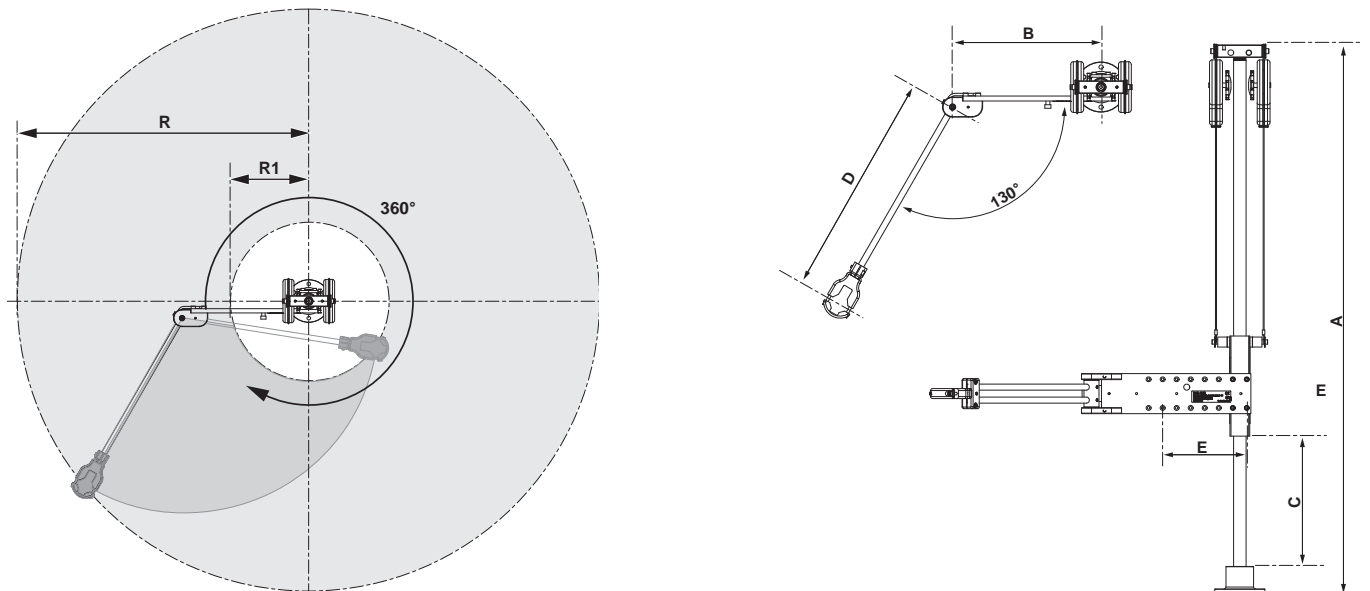

D53 folded working area product specification

MODEL	PART NUMBER	MAXIMUM TORQUE		HEIGHT A		WIDTH B		VERTICAL STROKE C		RADIUS D		FIXED STROKE E		RADIUS R		RADIUS R1		TOOL WEIGHT MAX	
		Nm	ft. lb	mm	in	mm	in	mm	in	mm	in	mm	in	mm	in	mm	in	kg	lb
D53-5S	615 810 706 0	5	3.7	732	28.8	248	9.76	270	10.6	370*	14.6*	168	6.6	546	21.5	140	5.5	0.8	1.76
D53-12S	615 810 707 0	12	8.9	888	35.0	298	11.73	425	16.7	420*	16.5*	168	6.6	639	25.2	146	5.8	1.5	3.3
D53-25S	615 810 708 0	25	18.4	1132	44.6	296	11.65	580	22.8	470*	18.5*	168	6.6	685	27	183	7.2	2.5	5.5
D53-50S	615 810 709 0	50	36.9	1147	45.2	336	1.1	520	20.5	440**	17.3**	228	9.0	698	27.5	154	6.1	5.0	11.0
D53-100S	615 810 710 0	100	73.8	1147	45.2	391	15.4	500	19.7	490**	19.3**	228	9.0	788	31	158	6.2	6.0	13.2

(*) With clamp - (**) Without clamp

D53 X/Y - Positioning arms

- D53 X/Y stands allows to track the tool position during assembly process
- Same tool stand as standard one
- 2 different versions with encoders
- Linear/Angular/Encoders : Linear arm
- Angular/Angular/Encoders : Swivel arm
- This arm is intended to be used together with our POSCO 500 to program a complete fastening sequence



LINEAR ARM

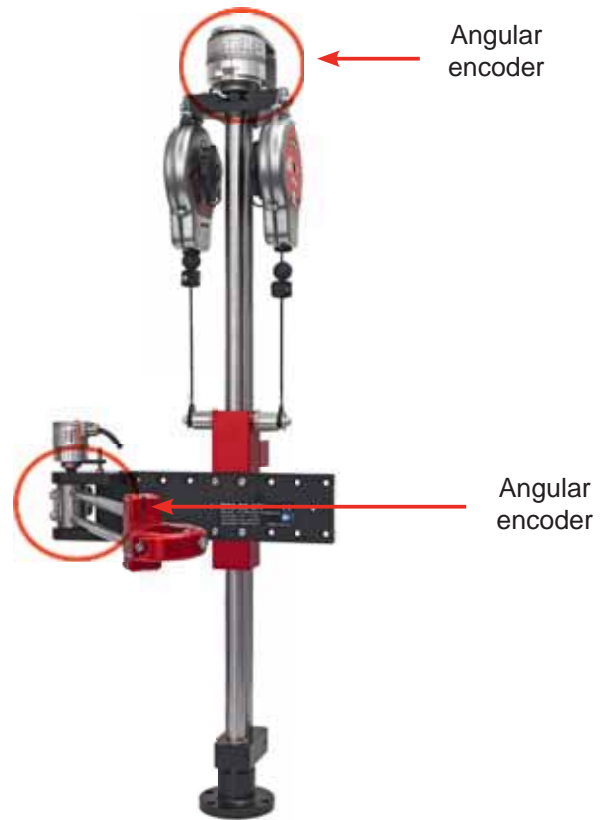

FOLDED ARM

For full tool clamp program, please see details on page 140

MODEL	PART NUMBER	MAXIMUM TORQUE		MAXIMUM TOOL WEIGHT		ARM EQUIPPED WITH	TOOL CLAMP DIAMETER (INCLUDED WITH THE ARM)		
		Nm	ft.lb	kg	lb.		mm	in.	
LINEAR ARM									
D53-5 X/Y AXLE*	615 397 874 0	5	3.7	0.8	1.8	1 x 5DU	28.5-41	1.12-1.62	
D53-12 X/Y AXLE*	615 397 875 0	12	8.8	1.5	3.3	2 x 5DU	28.5-41	1.12-1.62	
D53-25 X/Y AXLE*	615 397 876 0	25	18.4	2.5	5.5	2 x 5DU	28.5-41	1.12-1.62	
D53-50 X/Y AXLE*	615 397 877 0	50	36.8	5.0	11.0	2 x 15D			
D53-100 X/Y AXLE*	615 397 878 0	100	73.7	6.0	13.2	2 x 22D	To order separately		
FOLDED ARM									
D53-5S X/Y AXLE*	615 397 879 0	5	3.7	0.8	1.8	1 x 5DU	28.5-41	1.12-1.62	
D53-12S X/Y AXLE*	615 397 880 0	12	8.8	1.5	3.3	2 x 5DU	28.5-41	1.12-1.62	
D53-25S X/Y AXLE*	615 397 881 0	25	18.4	2.5	5.5	2 x 5DU	28.5-41	1.12-1.62	
D53-50S X/Y AXLE	615 397 882 0	50	36.8	5.0	11.0	2 x 15D			
D53-100S X/Y AXLE	615 397 883 0	100	73.7	6.0	13.2	2 x 22D	To order separately		

D53 X/Y - Dimensions

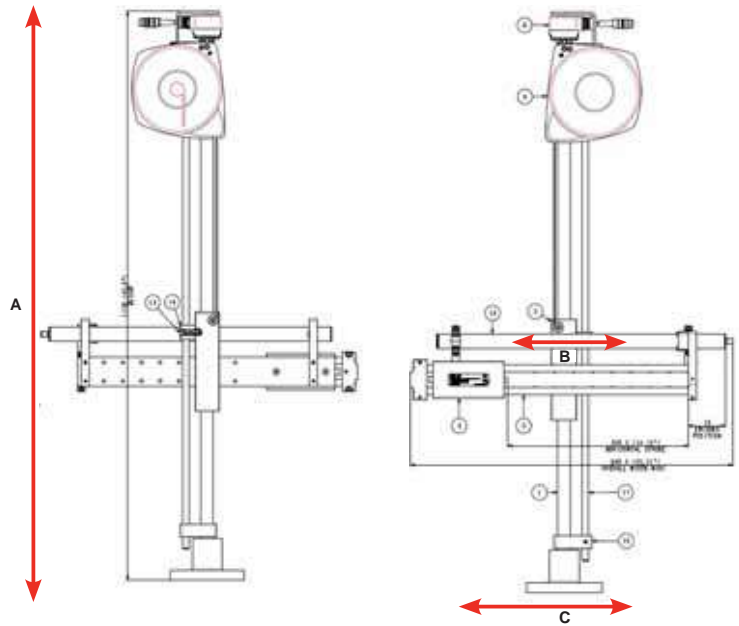
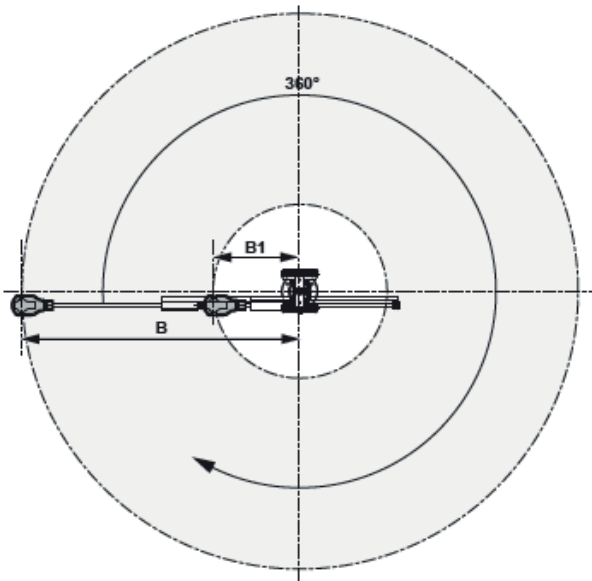

Linear arm

MODEL	PART NUMBER	A		B		C	
		mm	in.	mm	in.	mm	in.
D53-5S X/Y AXLE	615 397 879 0	789	31	248	9.8	370	14.6
D53-12S X/Y AXLE	615 397 880 0	945	37	298	11.7	420	16.5
D53-25S X/Y AXLE	615 397 881 0	1158	45.6	296	11.6	470	18.5
D53-50S X/Y AXLE	615 397 882 0	1158	45.6	336	13.2	440	17.3
D53-100S X/Y AXLE	615 397 883 0	1158	45.6	391	15.4	490	19.3

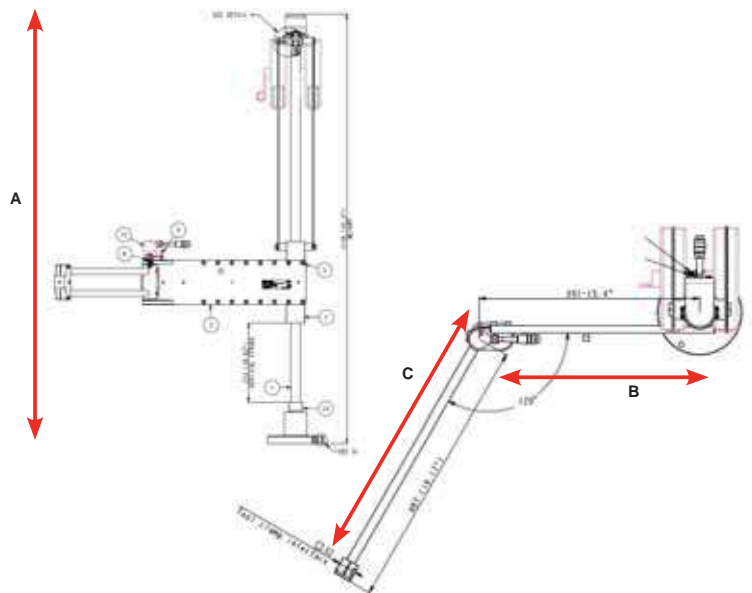
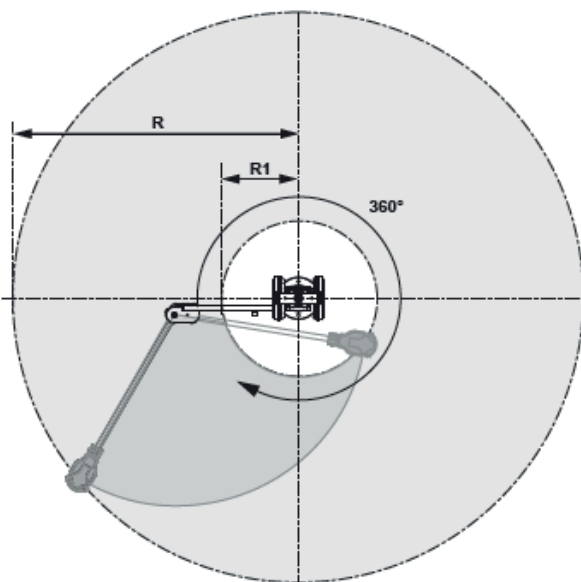



Folded arm

MODEL	PART NUMBER	A		B		C	
		mm	in.	mm	in.	mm	in.
D53-5S X/Y AXLE	615 397 879 0	789	31.1	248	9.8	370	14.6
D53-12S X/Y AXLE	615 397 880 0	945	37.2	298	11.7	420	16.5
D53-25S X/Y AXLE	615 397 881 0	1158	45.6	296	11.6	470	18.5
D53-50S X/Y AXLE	615 397 882 0	1158	45.6	336	13.2	440	17.3
D53-100S X/Y AXLE	615 397 883 0	1158	45.6	391	15.4	490	19.3

Tool clamp guide for D53 arms

Ordering Process:

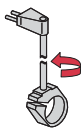
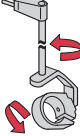
SELECT YOUR TOOL	SELECT THE ARM ACCORDING TO: - THE TORQUE APPLICATION - THE REACH NEEDED	ADD THE TOOL CLAMP IF NOT INCLUDED WITH THE ARM				ADD ADAPTORS IF YOU USE ROTATION CLAMPS
STEP 1	STEP 2	STEP 3				STEP 4
TOOL MODEL	D53 MODELS	TOOL CLAMP REFERENCES				COMMENTS
	Linear arms Swiveling arms	Universal Clamp	Spline	Vertical 2 axis rotation clamp Only for D53-12(S) and D53-25(S)	Horizontal 1 axe rotation clamp Only for D53-12(S) and D53-25(S)	Horizontal 2 axis rotation clamp Only for D53-12(S) and D53-25(S)
						
SB/SBP/SC2/SC/SCP(T)/ SH70 SLB SLK 011/015/022/031/047 SLC(P) Nose mount ERP 3/5/10/20 ECS/ECD 5	D53-5* / D53-12* / D53-25* * Tool clamp included	D53-5S* / D53-12S* / D53-25S* * Tool clamp included	615 810 835 0 Included (A) 28.5-41mm	615 396 615 0 + 409083 NOT Included To be ordered	615 396 615 0 + 409113 NOT Included To be ordered	615 396 615 0 + 409173 NOT Included To be ordered
SD/SDP/SDT SLK 003/007/010	D53-5* / D53-12* / D53-25* * Tool clamp included	D53-5S* / D53-12S* / D53-25S* * Tool clamp included	615 810 835 0 Included (A) 28.5-41mm	615 396 615 0 + 409093 NOT Included To be ordered	615 396 615 0 + 409123 NOT Included To be ordered	615 396 615 0 + 409183 NOT Included To be ordered
SLE SLC Top mount	D53-5 / D53-12	D53-5S / D53-12S	615 810 838 0 NOT Included To be ordered (A) 40-50 mm	615 396 615 0 + 409093 NOT Included To be ordered	615 396 615 0 + 409123 NOT Included To be ordered	615 396 615 0 + 409183 NOT Included To be ordered
EAP ECA 15/20/30	D53-5 / D53-12 / D53-25	D53-5S / D53-12S / D53-25S	615 810 838 0 NOT Included To be ordered (A) 40-50 mm			
SH 150/200/280/420... ERP 30/40 ERAL 1,5/2	D53-50 / D53-100	/ D53-50S / D53-100S	615 811 029 0 NOT Included To be ordered (B) 26-55 mm			
ERDL 4 ECD 50/70/120 EID 44-1200 - EID 75-900 - EID 65-800	D53-50 / D53-100	D53-50S / D53-100S		615 810 203 0 NOT Included To be ordered (C)		
ERDL 6	D53-100	D53-100S		615 810 205 0 NOT Included To be ordered (C)		
ERAL 4-90/110/120 ERAL 6-135 ECA 70... 150	D53-100	D53-100S		615 810 628 0 + 615 396 227 0 NOT Included To be ordered (D)		Parts to be welded
EID25-1200 EID 32-900 EDP/ERDL 1.5/2	D53-50	D53-50S		615 810 628 0 + 615 396 551 5 NOT Included To be ordered (D)		Parts to be welded

For the tools not mentioned in this list, please ask your local Desoutter contact to define the tool clamp.



A



B



C



D

TRA telescopic reaction arms

- From 12 up to 200 Nm (8.9 up to 148 ft.lb) torque capacity
- Several lengths available
- 90 degrees tool clamp interface for straight or pistol grip tools
- Limited tool clamp angle rotation to avoid side forces in the operator arm (ω) (Fig 1)



Need to order a balancer separately see page 146

**Universal balancer adapter

Benefits:

- Extremely lightweight carbon torque arm for improved comfort of use
- Flexible solution

MODEL	PART NUMBER	MAXIMUM TORQUE		MAX. MIN LENGTH		ω (deg)	WEIGHT		TOOL CLAMP DIAMETER (INCLUDED WITH THE ARM)	
		Nm	ft. lb	mm	in.		kg	lb	mm	in.
TRA12 1150*	615 810 089 0	12	8.9	516-1128	20.3-44.4	170	0.46	1.01	28-49	1.10-1.92
TRA12 1600*	615 810 090 0	12	8.9	666-1578	26.2-62.1	170	0.51	1.12	28-49	1.10-1.92
TRA12 2100*	615 810 091 0	12	8.9	835-2083	32.9-82.0	170	0.57	1.26	28-49	1.10-1.92
TRA25 1150*	615 810 092 0	25	18.4	524-1124	20.6-44.3	170	0.60	1.32	28-49	1.10-1.92
TRA25 1600*	615 810 093 0	25	18.4	674-1574	26.5-62.0	170	0.70	1.54	28-49	1.10-1.92
TRA25 2100*	615 810 094 0	25	18.4	841-2075	33.1-81.7	170	0.77	1.70	28-49	1.10-1.92
TRA25 2600*	615 810 095 0	25	18.4	1007-2573	39.6-101.3	170	0.86	1.89	28-49	1.10-1.92
TRA50 1600*	615 810 096 0	50	36.9	712-1624	28.0-63.9	40	1.14	2.51	28-50	1.10-1.97
TRA50 2100*	615 810 097 0	50	36.9	878-2125	34.6-83.7	40	1.24	2.73	28-50	1.10-1.97
TRA50 2600*	615 810 098 0	50	36.9	1045-2626	41.1-103.4	40	1.34	2.95	28-50	1.10-1.97
TRA100 1600	615 810 099 0	100	73.8	722-1628	28.4-64.1	30	1.47	3.24		
TRA100 2100	615 810 100 0	100	73.8	889-2129	35.0-83.8	30	1.41	3.11		
TRA100 2600	615 810 101 0	100	73.8	1056-2630	41.6-103.5	30	1.53	3.37		
TRA200 1600	615 810 102 0	200	148.0	726-1628	28.6-64.1	20	1.98	4.36		
TRA200 2100	615 810 103 0	200	148.0	893-2129	35.2-83.8	20	2.18	4.80		
TRA200 2600	615 810 104 0	200	148.0	1060-2630	41.7-103.5	20	2.39	5.27		

To order separately see below

(*) Universal TRA tool clamp included (**) Universal balancer adapters: 1 kit = 7 parts for all Desoutter balancer types: Part No. 615 397 922 5

Tool clamp guide for TRA arms

Ordering Process:

SELECT YOUR TOOL	SELECT THE ARM ACCORDING TO: - THE TORQUE APPLICATION - THE REACH NEEDED	ADD THE TOOL CLAMP IF NOT INCLUDED WITH THE ARM	ADD ADAPTORS IF NEEDED
STEP 1	STEP 2	STEP 3	STEP 4
TOOL MODEL	TRA MODEL	TOOL CLAMP REFERENCE	DESCRIPTION
SB/SBP - SC2/SCP/SCPT SD/SDP/SDT SH 70/150/200/280 SLB - SLK 003/007/010 SLK 011/015 SLK 022/031/047 - SLE - ECS SLC/SLCP - ERP 3/5/10/20 ECA 15/20 - ECD 5	TRA12* / 25* * Clamp included with the arm	615 810 118 0 Included with the arm	Universal Clamp 28 - 49mm (1.1 - 1.92 inch)
SH 420/500 - ERP 30/40 - EAP ERDL 1.5/2 - ERAL 1.5/2 ERAL 4-90 - ECA 30/40/60/70/90	TRA50* / 100 * Clamp included with the arm	615 810 137 0 Included with TRA50. To be ordered for TRA100	Universal Clamp 28 - 50mm (1.1 - 1.97 inch)
SH 700/850	TRA 100	615 811 363 0 NOT Included with the arm To be ordered	Special clamp
EAD 50-900	TRA 100	615 811 129 0 NOT Included with the arm To be ordered	Special clamp
EAD 70-800	TRA 100	615 811 130 0 NOT Included with the arm To be ordered	Special clamp
EAD 80-650	TRA 100	615 811 131 0 NOT Included with the arm To be ordered	Special clamp
EAD 105-500	TRA 100	615 811 132 0 NOT Included with the arm To be ordered	Special clamp
ERDL 4 - 60/80/135 ECD 50/70/120 EID 44/65/75	TRA 100 TRA 200	615 810 203 0 for TRA100 615 810 202 0 for TRA200 NOT Included with the arm To be ordered	Spline G1 D40,5
ERDL 6 - 170/220/250	TRA 200	615 810 204 0 NOT Included with the arm To be ordered	Spline G1 D50
EDP EID 25/32	TRA 50	615 810 628 0 + 615 396 551 5 NOT Included with the arm To be ordered	Clamp to be welded
ECD 20/30	TRA 50	615 810 628 0 + 615 396 191 0 NOT Included with the arm To be ordered	Clamp to be welded
ERAL 4 - 110/120/140/170 ECA 115/125/150	TRA 200	615 810 631 0 + 615 396 227 0 NOT Included with the arm To be ordered	Clamp to be welded
ERAL 4 - 225 ECA 200	TRA 200	615 810 631 0 + 615 396 230 0 NOT Included with the arm To be ordered	Clamp to be welded

For the tools not mentioned in this list, please ask your local Desoutter contact to define the tool clamp

Balancing Arms

D57, D58, D59



D57/D57X/D58 How To Order

1. Basic Stand
2. Tool Holder
3. Optional Accessories

D59 How To Order

1. Basic Stand
2. Tool Holder
3. Rail (supplied per meter, e.g. for 3m order (3) of PN. 409213)
4. Rail End Stops (2 required per complete rail)
5. Optional Accessories

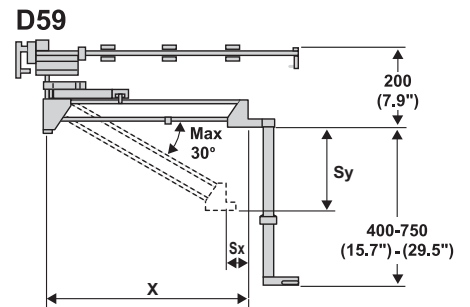
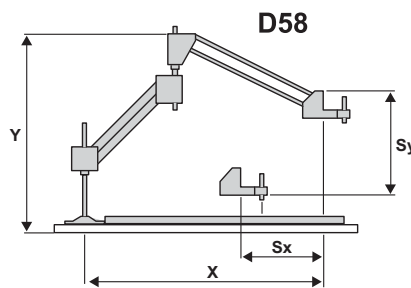
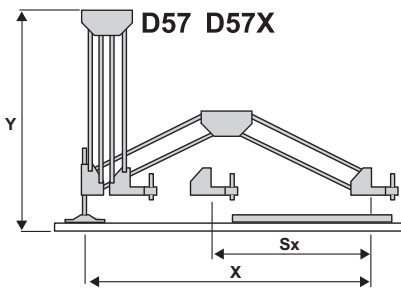
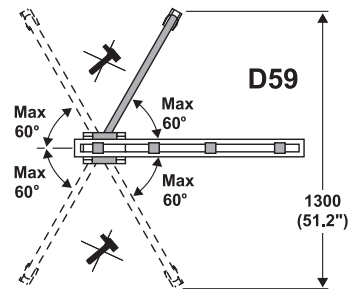

D57 / 58 / 59 BALANCING ARMS

PIC REF.	MODEL	PART NUMBER	MAXIMUM TORQUE		OVERALL HORIZONTAL (X)		OVERALL VERTICAL (Y)		STROKE HORIZONTAL (Sx)		STROKE VERTICAL (Sy)		TOOL WEIGHT CAPACITY		ACCESSORIES INCLUDED
			N.m	ft.lb	mm	in.	mm	in.	mm	in.	mm	in.	kg	lb	
A	D57	408903	20	14.75	700	25.55	550	21.6	510	20.7	95	3.74	2	4.4	BENCH MOUNT
A	D57X	408913	20	14.75	850	33.46	550	21.6	610	24.0	95	3.74	2	4.4	BENCH MOUNT
B	D58	408923	20	14.75	710	27.95	600	23.6	600	23.6	180	7.08	2	4.4	BENCH MOUNT
C	D59	408933	20	14.75	650	25.60	200	7.87	70	2.75	250	9.84	2	4.4	RAIL CARRIAGE

Balancing Arms

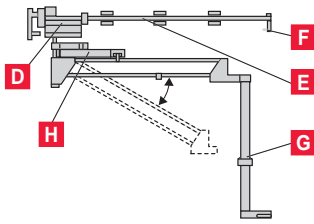
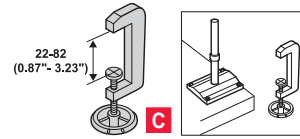
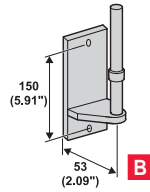
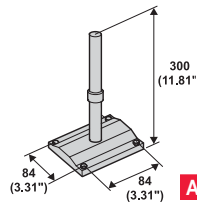

ACCESSORIES

ITEM	PART NO.	DESCRIPTION	D57 / D57X	D58	D59
A	408953	Bench Mount (Included with the stand)	X	X	
B	408963	Wall Mount Bracket	X	X	
C	408973	Table Stand Clamp	X	X	
	408993	Heavy Duty Spring 1 - 2,5 kg	X		
D	409253	Rail Carriage (Included with the stand)			X
E	409213	Rail Per Meter			X
F	409223	Rail End Stops			X
G	409203	Telescopic Height Adjustments			X
H	409233	Top Arrester / Vertical Lock			X
H	409243	Side Arrester / Horizontal Lock			X

must also order top arrester when using side arrester

D57/58/59 TOOL CLAMPS	Ø28.5-41mm	Ø40-50mm	Vertical 2 Axis Rotation	Horizontal Single Axis Rotation	Horizontal 2 Axis Rotation	Adaptor Sleeve Blank (supplied as standard with tool holders) to be machined to suit the tool
PART NO.	615 396 6140	615 396 6290	409083 Ø36mm (1.42) 409093 Ø46mm (1.8) 409103 Ø56mm (2.2)	409113 Ø36mm (1.42) 409123 Ø46mm (1.8) 409133 Ø56mm (2.2)	409173 Ø36mm (1.42) 409183 Ø46mm (1.8) 409193 Ø56mm (2.2)	409273 Ø46mm (1.8) (outside) Ø30mm (1.18) (inside) 409023 Ø56mm (2.2) (outside) Ø40mm (1.57) (inside)
Pneumatic Screwdrivers						
SB / SBP	X		409083	409113	409173	
SC2 / SCP / SCPT	X		409083	409113	409173	
SD / SDP	X		409093	409123	409183	Ring adaptor PN 409273 for SD
SH70 / SH150	X		409093	409123	409183	
Electric Screwdrivers						
SLK 003/007/010	X		409093	409123	409183	SLK adaptor PN 615 225 0650
SLB	X		409093	409123	409183	Ring adaptor PN 409273
SLK 011/015	X		409083	409113	409173	SLK adaptor PN 615 225 0660
SLK 022/031/047	X		409083	409113	409173	SLK adaptor PN 438963
SLC (nose mount)	X		409083	409113	409173	
SLC (top mount)			409093	409123	409183	
SLE		X	409093	409123	409183	Ring adaptor PN 409273
ECS	X		409083	409113	409173	
ECD5	X		409083	409113	409173	
ERD5	X		409083	409113	409173	
Drills						
DR 300	X		409083	409113	409173	
DR 350				409113	409173	
DR 750				409123	409183	Ring adaptor PN 409273

Bench Tidy Kit

& Bench Mounted Swinging Arm

- Three complete Bench Tidy Kits to suit 1.5m, 2m and 2.5m bench widths with flexibility of mounting in height and spacing of upright supports
- Everything included to set up a simple system within minutes, which can be enhanced with the accessories shown on the accessories page, adding to the versatility
- Supplied in 2 packs, needing only 10/13/17mm A/F wrenches and standard screwdrivers to assemble



COMPLETE BENCH TIDY KIT - READY TO ASSEMBLE

Each kit consist of:

- Tool Suspension Track of specified length
- Hose trolley
- Horizontal outrigger arms
- Hose clamp
- Vertical C-rail uprights with base for benchtop mounting (2 uprights with 1.5m and 2m kits, 3 with 2.5m kits)
- All necessary brackets, fittings and end stops/clamps
- Simple, step by step assembly instructions
- Tool Suspension trolley with 3 suspension rings and hoseclamp

EXAMPLE OF INSTALLATION

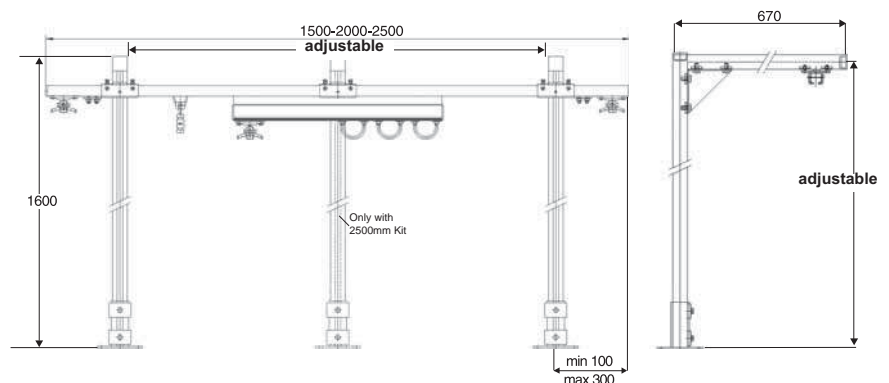

PIC REF	PART NUMBER	LENGTH OF SUSPENSION TRACK		HEIGHT		HORIZONTAL STROKE		WEIGHT LOAD		
		mm	in.	mm	in.	mm	in.	kg	lb	
BENCH TIDY										
A	111672	1500	59.0	1600	63	-	-	22	48.5	
A	111682	2000	78.7	1600	63	-	-	24	53.0	
A	111692	2500	98.4	1600	63	-	-	26	57.0	
BENCH MOUNTED SWINGING ARM										
B	66542			1600	63	630	24.8	10	22.0	

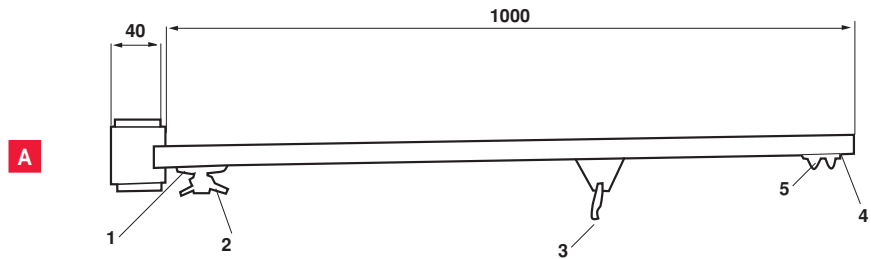

Bench Tidy Components

OPTIONAL ACCESSORIES

ITEM	PART NO.
Swivel Arm	
A Suitable for suspending equipment	66462
Max. load at 1000mm = 16kg	
Weight: 3kg	
Supplied complete with:	
1 End Clamp	66332
2 Hose Clip	66292
3 Suspension Trolley	66352
4 End Cap	66372
5 End Stop	66422

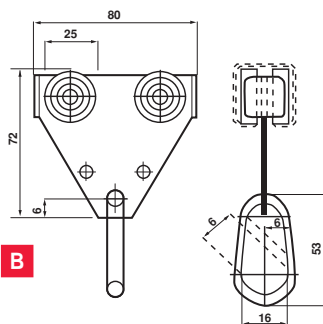

Suspension Trolley	
B Suspension trolley	66352
Use for suspending tool balancers, or coiled hoses	
To run in 32 x 30 'C' Rail Track	
Weight: 0.3kg	
Max. load: 20kg	
Materials:	
Chassis: Galvanised steel, plastic / Axles: Galvanised steel / Spring safety hook: Galvanised steel	

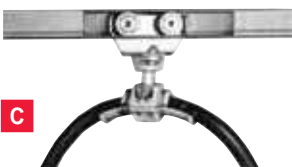

Hose Trolley	
C Hose Trolley	66282
Used in conjunction with Hose Clip to run in 32 x 30 'C' Rail Track	
Weight: 0.26kg	
Max. load: 20kg	
Materials:	
Bearing part: Steel plate, plastic covered / Rollers (ball bearings): Galvanised steel	
Ball & Socket Joint: Nylon / Small parts: Galvanised steel	

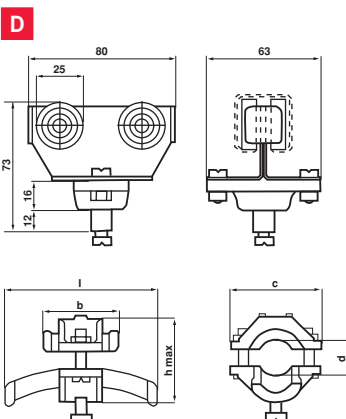

Hose Clip	
D Hose Clip	
Used to support coils of air hose or electric cable	

d		r		l		h max		b		c		b		PART NO.
mm	in.	mm	in.	mm	in.	mm	in.	mm	in.	mm	in.	mm	in.	
10-16	0.39-0.63	80	3.15	70	2.75	38	1.50	35	1.38	42	1.65	0.04	0.09	66292
17-25	0.67-0.98	125	4.92	100	3.94	47	1.85	50	1.97	50	1.97	0.06	0.13	66302
26-36	1.02-1.42	180	7.08	140	5.51	58	2.58	70	2.75	64	2.52	0.12	0.30	66322

Balancers - D, HU & R Series



- Steel housing
- Nylon (pic A)
Steel (pic B) cable
- Additional support chain included
- 10S / 15S / 22S with drum lock feature: operates only on spring failure

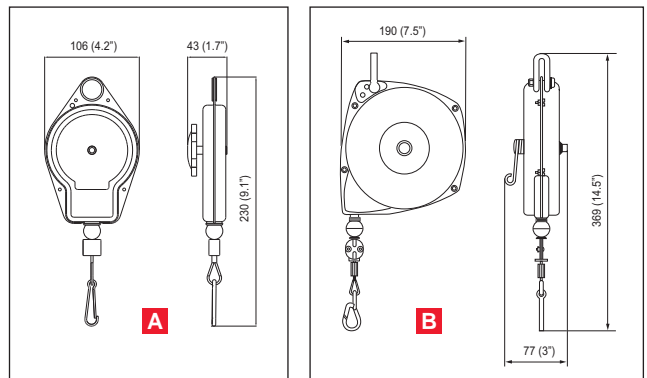

BALANCERS - 1DU - 22S

PIC REF	MODEL	PART NUMBER	LOAD RANGE				CABLE TRAVEL		WEIGHT	
			MIN. CAPACITY		MAX. CAPACITY		m	ft	kg	lb
			kg	lb	kg	lb				
A	1DU	52542	0	0	0.5	1.1	1.5	4.9	0.6	1.3
	2DU	50522	0.5	1.1	1.0	2.2	1.5	4.9	0.6	1.3
	2DUS	54532	0.5	1.1	1.0	2.2	3.0	9.8	0.6	1.3
	3DU	52862	1.0	2.2	1.5	3.3	1.5	4.9	0.6	1.3
	4DU	50532	1.0	2.2	2.0	4.4	1.5	4.9	0.6	1.3
	5DU	50542	1.4	3.1	2.4	5.3	1.5	4.9	0.6	1.3
B	10D	50052	2.5	5.5	5.0	11.0	2.4	7.8	2.7	6.0
	15D	50062	5.0	11.0	7.0	15.4	2.4	7.8	3.2	7.1
	22D	50072	6.0	13.2	10.0	22.0	2.4	7.8	3.2	7.1
	10S*	50572	2.0	4.4	5.0	11.0	2.4	7.8	2.7	6.0
	15S*	50582	5.0	11.0	7.0	15.4	2.4	7.8	3.2	7.1
	22S*	50592	6.0	13.2	10.0	22.0	2.4	7.8	3.2	7.1

* Balancers with drum lock features



- Steel housing
- Additional support chain included
- Polyurethane hose
- 1/4" in. thread

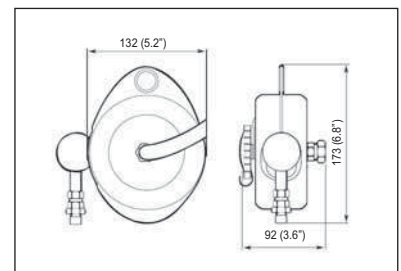

HOSE BALANCERS - 1HU - 4HU

MODEL	PART NUMBER	LOAD RANGE				HOSE TRAVEL		HOSE ID		WEIGHT	
		MIN. CAPACITY		MAX. CAPACITY		m	ft	mm	in.	kg	lb
		kg	lb	kg	lb						
1HU	52552	0	0	0.5	1.1	1.5	4.9	6.5	1/4	1.2	2.6
3HU	50552	0.5	1.1	1.4	3.1	1.0	3.3	6.5	1/4	1.2	2.6
4HU	50562	0.7	1.5	2.0	4.4	1.0	3.3	6.5	1/4	3.3	7.3
4HU-X*	205 148 128 4	0.7	1.5	2.0	4.4	1.0	3.3	6.5	1/4	3.3	7.3

Flow rate: 7.1 l/s (15cfm) - *L= 0.5



- Reaction free: holds the load weightless throughout the entire cable length
- Plastic housing & nylon cable: 2R, 4R
- Steel housing & steel cable: 5R, 10R
- Cable locks in the event of spring failure

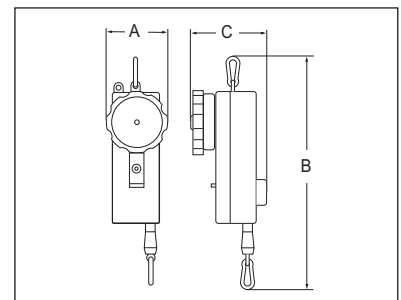

BALANCERS - REACTION FREE SELF-LOCK - 2R - 10R

MODEL	PART NUMBER	LOAD RANGE				CABLE TRAVEL		WEIGHT		DIMENSIONS					
		MIN. CAPACITY		MAX. CAPACITY		m	ft	kg	lb	A		B		C	
		kg	lb	kg	lb					mm	in.	mm	in.	mm	in.
2R	54422	0.7	1.5	1.3	2.9	1.7	5.5	0.5	1.1	72	2.8	245	9.6	108	4.3
4R	54432	1.0	2.2	2.0	4.4	1.7	5.5	0.5	1.1	72	2.8	245	9.6	108	4.3
5R	54442	1.7	3.7	3.5	7.7	2.4	7.8	2.3	5.1	116	4.6	427	16.8	155	6.1
10R	54452	3.0	6.6	6.0	13.2	2.4	7.8	2.3	5.1	116	4.6	427	16.8	155	6.1

Balancers - DF and DFL Series

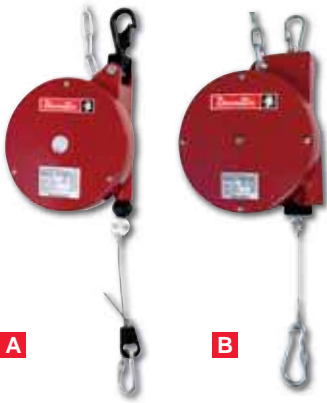

- Reaction free: holds the load weightless throughout the entire cable length
- Rigid and impact-resistant plastic and aluminum housing
- 360° swiveling safety hook for isolated suspension
- Screw-type safety hook for load suspension
- Standard safety chain
- Spring fracture safeguard, integrated drum lock

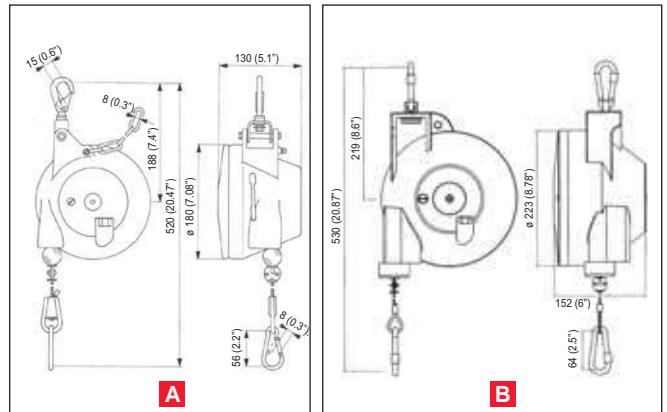

BALANCERS - 5DF - 55 DF

PIC REF	MODEL	PART NUMBER	LOAD RANGE				CABLE TRAVEL		WEIGHT	
			MIN. CAPACITY		MAX. CAPACITY		m	ft	kg	lb
			kg	lb	kg	lb				
A	5DF	615 805 011 0	3.0	6.6	5.0	11.0	2.0	6.6	2.9	6.4
	7DF	615 805 012 0	4.5	9.9	7.0	15.4	2.0	6.6	3.1	6.8
	10DF	615 805 013 0	6.0	13.2	10.0	22.0	2.0	6.6	3.2	7.1
	14DF	615 805 014 0	9.0	19.8	14.0	30.9	2.0	6.6	3.4	7.5
	17DF	615 805 015 0	13.0	28.7	17.0	37.5	2.0	6.6	3.6	7.9
B	21DF	615 805 016 0	16.0	35.3	21.0	46.3	2.0	6.6	3.8	8.4
	25DF	615 805 017 0	15.0	33.1	25.0	55.1	2.0	6.6	7.8	17.2
	35DF	615 805 018 0	25.0	55.1	35.0	77.2	2.0	6.6	8.9	16.6
	45DF	615 805 019 0	35.0	77.2	45.0	99.2	2.0	6.6	9.5	20.9
	55DF	615 805 020 0	45.0	99.2	55.0	121.2	2.0	6.6	9.7	21.4

A Plastic housing B Aluminum housing



- Reaction free: holds the load weightless throughout the entire cable length
- Rigid and impact-resistant aluminum housing
- 360° swiveling safety hook
- Cable extension limit stop for overload protection
- Screw-type safety hook for load suspension
- Standard safety chain
- Standard spring fracture safeguard integrated drum lock
- Ferrule for securing cable end
- Freewheel device for protection against handling errors

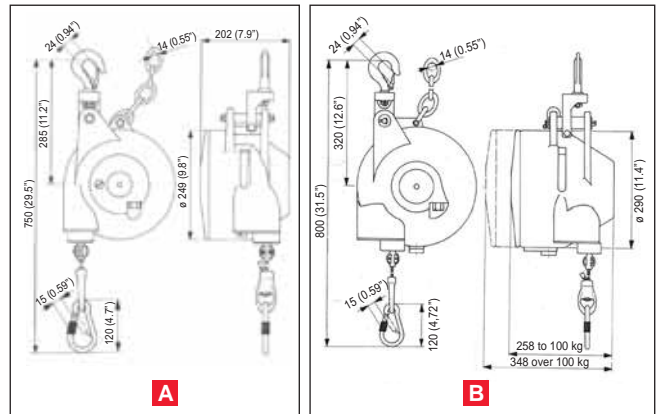

BALANCERS - 20DFL - 200DFL

PIC REF	MODEL	PART NUMBER	LOAD RANGE				CABLE TRAVEL		WEIGHT	
			MIN. CAPACITY		MAX. CAPACITY		m	ft	kg	lb
			kg	lb	kg	lb				
A	20DFL	615 805 021 0	12	26.5	20	44.1	2.0	6.6	14.8	32.6
	30DFL	615 805 022 0	20	44.1	30	66.1	2.0	6.6	15.2	33.5
	45DFL	615 805 023 0	30	66.1	45	99.2	2.0	6.6	16.9	37.2
	60DFL	615 805 024 0	45	99.2	60	132.3	2.0	6.6	17.3	38.1
	75DFL	615 805 025 0	60	132.3	75	165.3	2.0	6.6	18.7	41.2
	90DFL	615 805 026 0	75	165.3	90	198.4	2.0	6.6	19.7	43.4
	100DFL	615 805 027 0	90	198.4	100	220.4	2.0	6.6	20.9	46.1
	115DFL	615 805 028 0	100	220.4	115	253.5	3.0	9.8	41.8	92.1
	130DFL	615 805 029 0	115	253.5	130	286.6	3.0	9.8	43.2	95.2
	140DFL	615 805 030 0	130	286.6	140	308.6	3.0	9.8	44.6	98.3
B	150DFL	615 805 031 0	140	308.6	150	330.7	3.0	9.8	46.0	101.4
	170DFL	615 805 032 0	150	330.7	170	374.8	3.0	9.8	46.4	102.3
	180DFL	615 805 033 0	170	374.8	180	396.8	3.0	9.8	46.7	102.9
	190DFL	615 805 034 0	180	396.8	190	418.9	3.0	9.8	47.0	103.6
	200DFL	615 805 035 0	190	418.9	200	440.9	3.0	9.8	47.3	104.2

Tool Holsters

Desoutter Tool Holster - DTH42



- Adapted for all straight or pistol grip tools with an outside diameter of maximum 42 mm
- The mounting plate can be fastened in several positions and the plastic ring angle can be set at different angles

PART NUMBER	DESCRIPTION	MAX. DIAMETER	
		mm	in.
107 892	DTH-42	42	1.65

- To be used with:
 - E-LIT pistol
 - SB/SBP/SCBP
 - SC/SCP/SCPT SC2
 - SD/SDP/SDT
 - SLE/SLK/SLB
 - ECS
 - ERS
 - DR300/DR500/DR750
 - CP4444/CP4447/CP4450
 - CP4475

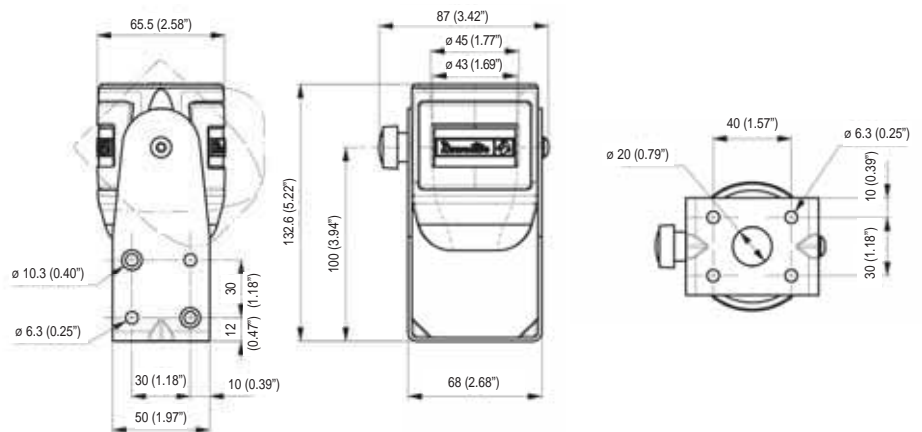

Desoutter Tool Holster - DTH TWIN

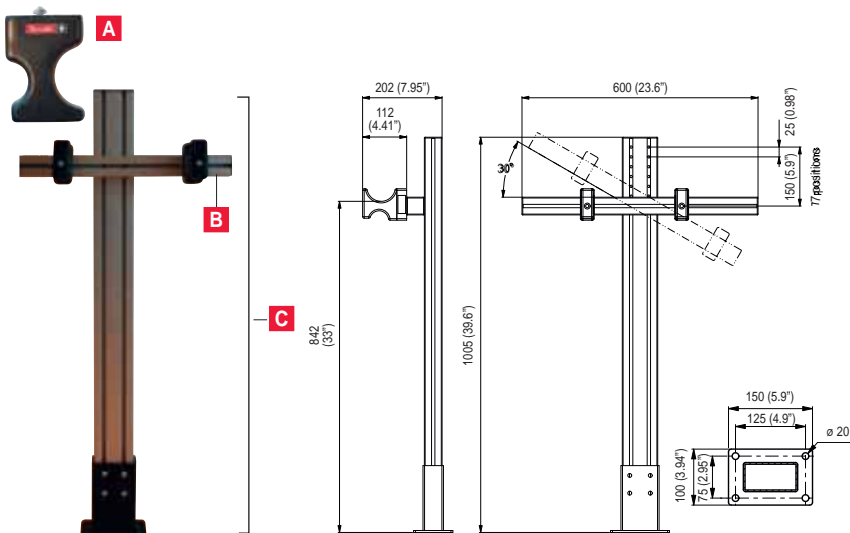

PIC REF	PART NUMBER	DESCRIPTION
		mm
A*	615 811 411 0	DTH TWIN (single) without rail
B	615 811 412 5	DTH TWIN rail KIT with 2 TWIN holders
C	615 811 413 5	DTH TWIN stand kit with base & 2 TWIN holders

* Includes screw and fixation for rail type Bosch 10mm slot

Automatic Screw Dispenser - ASD

Boost your productivity and efficiency

To be used for the assembly of:

- Electronics: TV, mobile phones, computers
- Medical products
- Small appliances

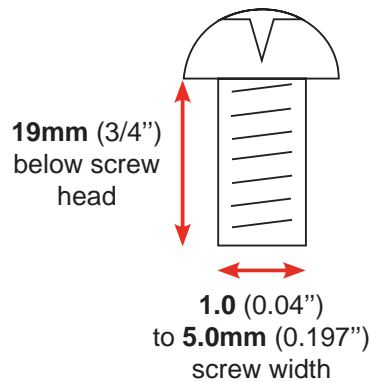

- **Widest range of screw sizes:** between 1.0 (0.04") and 5.0mm (0.197") thread diameters (about 11 different screw sizes) including screws with captive washers and up to 19mm (3/4") screw length (under head)
- **Complete:** supplied with universal feeding rail to avoid buying additional and expensive spare rails
- **Fully adjustable:** vibration time, vibration intensity, and drum rotation time adjustments allow the user to optimize the screw feed rate
- **Quiet operation & easy to service**
- Includes: rail adjustment kit, AC adapter and ground wire

PART NUMBER	POWER PLUG	SCREW RANGE		RAIL ADJUSTMENT KIT	DIMENSIONS						POWER	
		SIZE	LENGTH		L		H		W			
			mm	in.	mm	in.	mm	in.	mm	in.		
615 810 472 0	UK	M1.0 to M5.0	Up	Up	included	126	5	147	5.8	182	7.2	AC 100 ~ 240V
615 810 473 0	EUR	M1.0 to M5.0	to 19	to 3/4"								
615 810 474 0	US	0.04" to 0.197"	(under head)	(under head)								

Fastening Accessories

Fastener Head Type	Drives
Pozidriv/Supadriv	4mm Wing Shank
Phillips	5mm Wing Shank
Torx	4mm Halfmoon
Torx Tamper Proof	1/4" Hex** Insert (C6.3) (ISO1173/ DIN3126)
Torx Plus	1/4" Hex Power Drive (E6.3) (ISO1173/ DIN3126)
Internal Hex	5/16" Hex Power Drive
External Hex	3mm Hex Power Drive (A3) (ISO1173)
Slot	Thread Drive
	Square Drive

** Note: to be used with a bit holder

Torx®, Torx Plus® are registered trademarks of Camcar Div., Textron Inc.
ACR®, Pozidriv®, Torq-Set®, Tri-Wing® are registered trademarks of Phillips Screw Co.



Bits for Precision Screw

Drive: ø 3mm HEX Drive

PH	D ø		LENGTH L		PART NO
	mm	in	mm	in	
00	2.5	0.10	50	1.97	615 820 226 0
0	2.5	0.10	50	1.97	615 820 227 0
1	4.0	0.16	50	1.97	615 820 228 0

W	t		LENGTH L		PART NO
	mm	in	mm	in	
1.8	0.3	0.01	50	1.97	615 820 229 0
2	0.4	0.02	50	1.97	615 820 230 0
2.5	0.4	0.02	50	1.97	615 820 231 0
3	0.5	0.02	50	1.97	615 820 232 0*
3.5	0.6	0.02	50	1.97	615 820 234 0
4	0.5	0.02	50	1.97	615 820 233 0
4	0.8	0.03	50	1.97	615 820 236 0
4.5	0.6	0.02	50	1.97	615 820 235 0
5.5	0.8	0.03	50	1.97	615 820 237 0

T	A	D ø		LENGTH L		PART NO	
		mm	in	mm	in		
T6	1.7	0.06	2.2	0.09	50	1.97	615 820 240 0
T7	2.0	0.08	2.2	0.09	50	1.97	615 820 241 0
T8	2.3	0.09	2.8	0.11	50	1.97	615 820 242 0
T10	2.7	0.11	3.0	0.12	50	1.97	615 820 243 0

PZ	D ø		LENGTH L		PART NO
	mm	in	mm	in	
0	3	0.12	50	1.97	615 820 238 0
1	4	0.16	50	1.97	615 820 239 0

* Production upon your order.

Bits for Precision Screw

Drive: 5/16" = 8mm HEX Drive

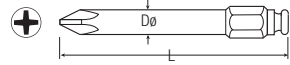

PH	Dø		LENGTH L		PART NO
	mm	in	mm	in	
1	4.5	0.18	32	1.26	615 820 326 0
1	4.5	0.18	50	1.97	615 820 645 0
1	-	-	93	3.66	615 820 720 0
2	6.0	0.24	50	1.97	615 820 646 0
2	-	-	93	3.66	615 820 721 0
3	-	-	93	3.66	615 820 722 0

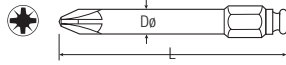

PZ	Dø		LENGTH L		PART NO
	mm	in	mm	in	
1	-	-	52	2	615 820 723 0
1	-	-	92	3.62	615 820 724 0
2	6.0	0.24	50	1.97	615 820 647 0
2	6.0	0.24	75	2.95	615 820 697 0
2	6.0	0.24	92	3.62	615 820 355 0

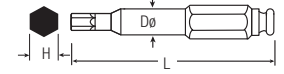

H	Dø		LENGTH L		PART NO
	mm	in	mm	in	
H3	6.0	0.24	50	1.97	615 820 327 0*
H4	6.0	0.24	50	1.97	615 820 328 0*
H5	8.0	0.31	50	1.97	615 820 329 0
H6	8.0	0.31	50	1.97	615 820 330 0
H8	8.0	0.31	50	1.97	615 820 331 0*

* Production upon your order.

W	t		LENGTH L		PART NO
	mm	in	mm	in	
3	0.5	0.02	76	2.99	615 820 209 0
3	0.5	0.02	51	2.01	615 820 648 0
3.7	0.8	0.03	52	2.05	615 820 725 0
5	1.0	0.04	52	2.05	615 820 726 0
6.2	1.0	0.04	52	2.05	615 820 727 0
8.8	1.3	0.05	52	2.05	615 820 728 0
3.1	0.6	0.02	103	4.06	615 820 729 0
5	1.0	0.04	154	6.06	615 820 730 0

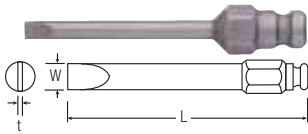

H	LENGTH L		PART NO
	mm	in	
H5	70	2.76	615 820 649 0
H6	70	2.76	615 820 650 0
H8	70	2.76	615 820 651 0
H10	70	2.76	615 820 652 0

Drive: 11mm HEX Drive

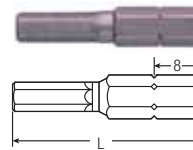

H	LENGTH L		PART NO
	mm	in	
H5	70	2.76	615 820 649 0
H6	70	2.76	615 820 650 0
H8	70	2.76	615 820 651 0
H10	70	2.76	615 820 652 0



Drive: ø 4mm Shank Drive - Wing Shank

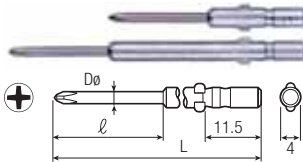

PH	Dø		l	LENGTH L		PART NO	
	mm	in		mm	in		10 pcs
00	1.2	0.05	20	0.79	40	1.57	615 820 027 0
00	1.5	0.06	20	0.79	40	1.57	615 820 412 0
00	1.5	0.06	20	0.79	60	2.36	615 820 413 0
00	2.0	0.08	20	0.79	40	1.57	615 820 414 0
00	2.0	0.08	20	0.79	60	2.36	615 820 415 0
0	1.4	0.06	20	0.79	40	1.57	615 820 028 0
0	1.4	0.06	20	0.79	60	2.36	615 820 029 0
0	1.7	0.07	20	0.79	40	1.57	615 820 416 0
0	1.7	0.07	20	0.79	60	2.36	615 820 417 0
0	2.0	0.08	20	0.79	40	1.57	615 820 030 0
0	2.0	0.08	20	0.79	60	2.36	615 820 031 0
0	2.0	0.08	20	0.79	80	3.15	615 820 032 0
0	2.0	0.08	20	0.79	100	3.94	615 820 033 0
0	2.5	0.10	20	0.79	40	1.57	615 820 418 0
0	2.5	0.10	20	0.79	60	2.36	615 820 419 0
0	2.5	0.10	20	0.79	80	3.15	615 820 034 0
0	2.5	0.10	20	0.79	100	3.94	615 820 035 0
1	3.0	0.12	20	0.79	40	1.57	615 820 420 0
1	3.0	0.12	20	0.79	60	2.36	615 820 036 0
1	3.0	0.12	20	0.79	80	3.15	615 820 037 0
1	3.0	0.12	20	0.79	100	3.94	615 820 038 0
1	3.0	0.12	20	0.79	120	4.72	615 820 442 0
1	4.0	0.16	-	-	40	1.57	615 820 421 0
1	4.0	0.16	-	-	60	2.36	615 820 039 0
1.3	0.3	0.01	20	0.79	40	1.57	615 820 044 0
1.7	0.3	0.01	20	0.79	40	1.57	615 820 045 0
2	0.4	0.02	20	0.79	40	1.57	615 820 046 0
2	4.0	0.16	-	-	40	1.57	615 820 422 0
2	4.0	0.16	-	-	60	2.36	615 820 040 0
2	4.0	0.16	-	-	80	3.15	615 820 041 0
2	4.0	0.16	-	-	100	3.94	615 820 042 0
2	4.0	0.16	-	-	120	4.72	615 820 043 0
2.5	0.4	0.02	20	0.79	40	1.57	615 820 047 0

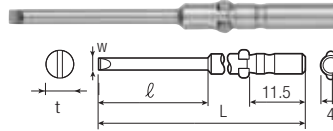

W	t		l	LENGTH L		PART NO	
	mm	in		mm	in		10 pcs
2	0.3	0.01	20	0.79	40	1.57	615 820 423 0
2.5	0.3	0.01	20	0.79	40	1.57	615 820 424 0
3	0.4	0.02	20	0.79	40	1.57	615 820 048 0
4	0.5	0.02	-	-	40	1.57	615 820 425 0

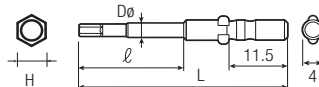

H	Dø		l	LENGTH L		PART NO	
	mm	in		mm	in		10 pcs
H1.5	2	0.08	20	0.79	60	2.36	615 820 426 0
H2	3	0.12	20	0.79	60	2.36	615 820 427 0
H2.5	3	0.12	20	0.79	60	2.36	615 820 428 0
H3	4	0.16	-	-	60	2.36	615 820 429 0

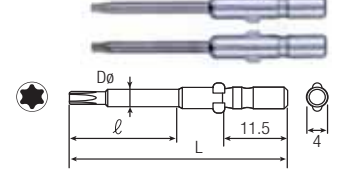

T	Dø		l	LENGTH L		PART NO	
	mm	in		mm	in		10 pcs
T1	1.5	0.06	20	0.79	40	1.57	615 820 670 0
T2	1.5	0.06	20	0.79	40	1.57	615 820 671 0
T3	1.7	0.07	20	0.79	40	1.57	615 820 672 0
T4	1.8	0.07	20	0.79	40	1.57	615 820 673 0
T5	2.0	0.08	20	0.79	40	1.57	615 820 049 0
T5	2.0	0.08	20	0.79	60	2.36	615 820 050 0
T6	2.0	0.08	20	0.79	40	1.57	615 820 051 0
T6	2.0	0.08	20	0.79	60	2.36	615 820 052 0
T7	2.0	0.08	20	0.79	60	2.36	615 820 053 0
T8	3.0	0.12	20	0.79	40	1.57	615 820 674 0
T8H	4.0	0.16	-	-	60	2.36	615 820 054 0
T9	3.0	0.12	20	0.79	40	1.57	615 820 675 0
T10	3.0	0.12	20	0.79	40	1.57	615 820 676 0
T10H	4.0	0.16	-	-	60	2.36	615 820 055 0

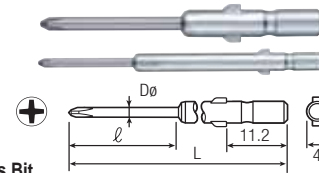

PH	Dø		l	LENGTH L		PART NO	
	mm	in		mm	in		10 pcs
00	1.5	0.06	20	0.79	40	1.57	615 820 390 0
00	1.5	0.06	20	0.79	60	2.36	615 820 391 0
0	1.5	0.06	20	0.79	40	1.57	615 820 392 0
0	1.5	0.06	20	0.79	60	2.36	615 820 393 0
0	1.7	0.07	20	0.79	40	1.57	615 820 394 0
0	1.7	0.07	20	0.79	60	2.36	615 820 395 0
0	2	0.08	20	0.79	40	1.57	615 820 396 0
0	2	0.08	20	0.79	60	2.36	615 820 397 0

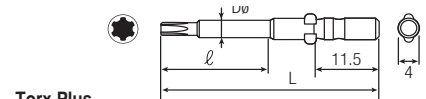

IP	Dø		l	LENGTH L		PART NO	
	mm	in		mm	in		10 pcs
4IP	1.8	0.07	20	0.79	60	2.36	615 820 371 0
5IP	2.0	0.08	20	0.79	60	2.36	615 820 372 0
6IP	2.5	0.10	20	0.79	60	2.36	615 820 373 0
8IP	3.0	0.12	20	0.79	60	2.36	615 820 374 0
10IP	3.0	0.12	20	0.79	60	2.36	615 820 375 0

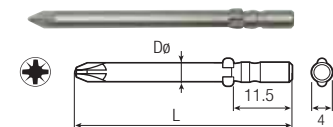

PZ	Dø		LENGTH L		PART NO
	mm	in	mm	in	
0	4	0.16	60	2.36	615 820 369 0
1	4	0.16	60	2.36	615 820 370 0
2	4	0.16	60	2.36	615 820 383 0

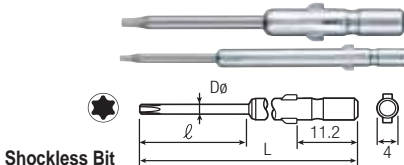

T	Dø		l	LENGTH L		PART NO	
	mm	in		mm	in		10 pcs
T5	2	0.08	20	0.79	40	1.57	615 820 398 0
T5	2	0.08	20	0.79	60	2.36	615 820 399 0
T6	2	0.08	20	0.79	40	1.57	615 820 400 0
T6	2	0.08	20	0.79	60	2.36	615 820 401 0

Bits for Precision Screw

Drive: \varnothing 5mm Shank Drive - Wing Shank

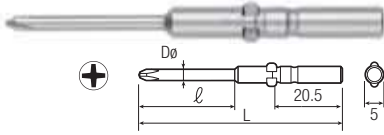

PH	Dø		l		LENGTH L		PART NO
	mm	in	mm	in	mm	in	
00	1.5	0.06	-	-	60	2.36	615 820 430 0
0	2.5	0.10	25	0.98	60	2.36	615 820 431 0
1	3.0	0.12	30	1.18	60	2.36	615 820 432 0
1	3.0	0.12	30	1.18	80	3.15	615 820 071 0
1	5.0	0.20	-	-	60	2.36	615 820 433 0
2	5.0	0.20	-	-	60	2.36	615 820 434 0
2	5	0.2	-	-	80	3.15	615 820 072 0
2	5	0.2	-	-	100	3.15	615 820 073 0
2	5.0	0.20	-	-	120	4.72	615 820 074 0
2	5.0	0.20	-	-	150	5.91	615 820 075 0

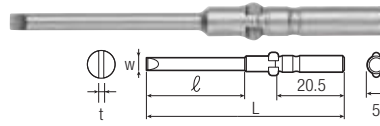

w	t		l		LENGTH L		PART NO
	mm	in	mm	in	mm	in	
3	0.4	0.02	30	1.18	60	2.36	615 820 435 0
4	0.6	0.02	30	1.18	60	2.36	615 820 436 0
5	0.7	0.03	-	-	60	2.36	615 820 437 0

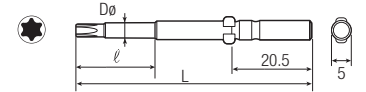

T	Dø		l		LENGTH L		PART NO
	mm	in	mm	in	mm	in	
T5	2.0	0.08	20	0.79	60	2.36	615 820 677 0
T6	2.5	0.10	20	0.79	60	2.36	615 820 678 0
T7	2.5	0.10	20	0.79	60	2.36	615 820 679 0
T8	3.0	0.12	20	0.79	60	2.36	615 820 680 0
T9	3.0	0.12	20	0.79	60	2.36	615 820 681 0
T10	3.0	0.12	20	0.79	60	2.36	615 820 682 0
T15	4.0	0.16	20	0.79	60	2.36	615 820 683 0
T20	-	-	-	-	60	2.36	615 820 684 0
T25	-	-	-	-	60	2.36	615 820 685 0

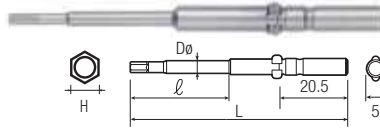

H	Dø		l		LENGTH L		PART NO
	mm	in	mm	in	mm	in	
H2	3	0.12	30	1.18	70	2.76	615 820 438 0
H2.5	3	0.12	30	1.18	70	2.76	615 820 439 0
H3	4	0.16	30	1.18	70	2.76	615 820 440 0
H4	5	0.20	-	-	70	2.76	615 820 441 0

Drive: \varnothing 4mm - Halfmoon

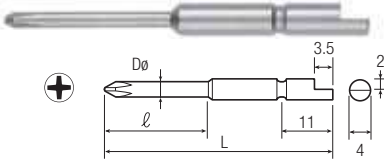

PH	Dø		l		LENGTH L		PART NO
	mm	in	mm	in	mm	in	
000	1.5	0.06	20	0.79	44	1.73	615 820 386 0
000	1.5	0.06	20	0.79	64	2.52	615 820 389 0
00	1.5	0.06	20	0.79	44	1.73	615 820 406 0
00	1.5	0.06	20	0.79	64	2.52	615 820 407 0
00	2.0	0.08	20	0.79	64	2.52	615 820 078 0
0	1.8	0.07	20	0.79	44	1.73	615 820 076 0
0	1.8	0.07	20	0.79	64	2.52	615 820 077 0
0	2.0	0.08	20	0.79	44	1.73	615 820 408 0
0	2.0	0.08	20	0.79	64	2.52	615 820 409 0
0	2.5	0.10	20	0.79	44	1.73	615 820 079 0
0	2.5	0.10	20	0.79	64	2.52	615 820 080 0
1	3.0	0.12	20	0.79	44	1.73	615 820 410 0
1	3.0	0.12	20	0.79	64	2.52	615 820 411 0
1	4.0	0.16	20	0.79	44	1.73	615 820 081 0
1	4.0	0.16	20	0.79	64	2.52	615 820 082 0
2	4.0	0.16	20	0.79	44	1.73	615 820 083 0
2	4.0	0.16	20	0.79	64	2.52	615 820 084 0

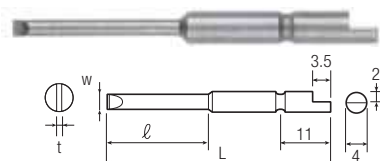

w	t		l		LENGTH L		PART NO
	mm	in	mm	in	mm	in	
2	0.3	0.01	20	0.79	44	1.73	615 820 086 0
2.5	0.3	0.01	20	0.79	44	1.73	615 820 087 0
3	0.4	0.02	20	0.79	44	1.73	615 820 088 0
4	0.5	0.02	-	-	44	1.73	615 820 089 0

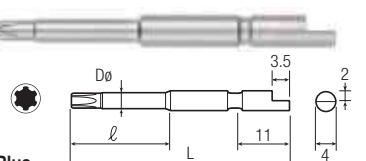

IP	Dø		l		LENGTH L		PART NO
	mm	in	mm	in	mm	in	
2IP	1.5	0.06	20	0.79	44	1.73	615 820 381 0
2IP	1.5	0.06	20	0.79	64	2.52	615 820 367 0
3IP	1.7	0.07	20	0.79	44	1.73	615 820 382 0
3IP	1.7	0.07	20	0.79	64	2.52	615 820 368 0
4IP	1.8	0.07	20	0.79	44	1.73	615 820 357 0
4IP	1.8	0.07	20	0.79	64	2.52	615 820 358 0
5IP	2.0	0.08	20	0.79	44	1.73	615 820 359 0
5IP	2.0	0.08	20	0.79	64	2.52	615 820 360 0
6IP	2.5	0.10	20	0.79	44	1.73	615 820 361 0
6IP	2.5	0.10	20	0.79	64	2.52	615 820 362 0
8IP	3.0	0.12	20	0.79	44	1.73	615 820 363 0
8IP	3.0	0.12	20	0.79	64	2.52	615 820 364 0
10IP	3.0	0.12	20	0.79	44	1.73	615 820 365 0
10IP	3.0	0.12	20	0.79	64	2.52	615 820 366 0

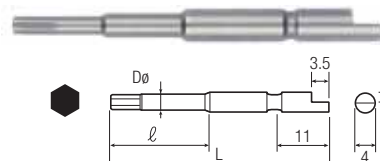

H	Dø		l		LENGTH L		PART NO
	mm	in	mm	in	mm	in	
H1.5	2.0	0.08	20	0.79	44	1.73	615 820 091 0
H2	3.0	0.12	20	0.79	44	1.73	615 820 092 0
H2.5	3.0	0.12	20	0.79	44	1.73	615 820 093 0
H3	4.0	0.16	-	-	44	1.73	615 820 094 0

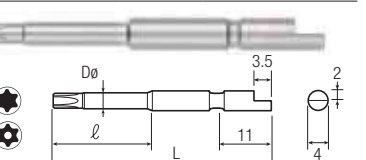

Torx Torx Tapered Shank Torx Tamper Proof

T	Dø		l		LENGTH L		PART NO
	mm	in	mm	in	mm	in	
T1	1.5	0.06	20	0.79	44	1.73	615 820 663 0
T2	1.5	0.06	20	0.79	44	1.73	615 820 664 0
T3	1.7	0.07	20	0.79	44	1.73	615 820 665 0
T3	1.7	0.07	20	0.79	64	2.52	615 820 384 0
T4	1.8	0.07	20	0.79	44	1.73	615 820 666 0
T4	1.8	0.07	20	0.79	64	2.52	615 820 385 0
T5	2.0	0.08	20	0.79	44	1.73	615 820 102 0
T5	2.0	0.08	20	0.79	64	2.52	615 820 103 0
T6	2.0	0.08	20	0.79	44	1.73	615 820 104 0
T6	2.0	0.08	20	0.79	64	2.52	615 820 105 0
T7	-	-	-	-	44	1.73	615 820 667 0
T8	3.0	0.12	20	0.79	44	1.73	615 820 668 0
T8H	3.0	0.12	20	0.79	44	1.73	615 820 106 0
T8H	3.0	0.12	20	0.79	64	2.52	615 820 107 0
T9	3.0	0.12	20	0.79	44	1.73	615 820 669 0
T10H	3.0	0.12	20	0.79	44	1.73	615 820 108 0
T10H	3.0	0.12	20	0.79	64	2.52	615 820 109 0
T15H	4.0	0.16	20	0.79	64	2.52	615 820 110 0
T20	-	-	-	-	64	2.52	615 820 388 0

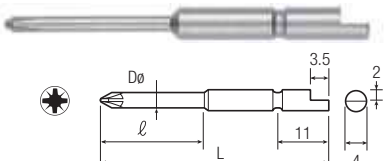

PZ	Dø		l		LENGTH L		PART NO
	mm	in	mm	in	mm	in	
0	2.5	0.10	20	0.79	44	1.73	615 820 377 0
0	2.5	0.10	20	0.79	64	2.52	615 820 378 0
1	4.0	0.16	-	-	44	1.73	615 820 379 0
1	4.0	0.16	-	-	64	2.52	615 820 380 0
1	3.0	0.12	30	1.18	90	3.54	615 820 387 0

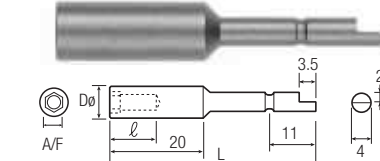

AF	Dø		l		LENGTH L		PART NO
	mm	in	mm	in	mm	in	
AF2.3	4.0	0.16	5	0.20	44	1.73	615 820 095 0
AF2.5	4.0	0.16	5	0.20	44	1.73	615 820 096 0
AF3	5.0	0.20	8	0.31	44	1.73	615 820 097 0
AF4	7.0	0.28	10	0.39	44	1.73	615 820 098 0
AF4.5	7.0	0.28	10	0.39	44	1.73	615 820 099 0
AF5	8.0	0.31	15	0.59	44	1.73	615 820 100 0
AF5.5	8.0	0.31	15	0.59	44	1.73	615 820 101 0

Insert Bits



Drive: 1/4" = 6.35mm HEX Shank - DIN3126-C6.3

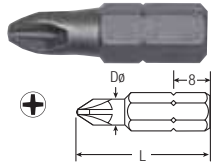

PH	Dø		LENGTH L		PART NO
	mm	in	mm	in	
0	3.0	0.12	25.0	0.98	615 820 516 0
1	4.5	0.18	25.0	0.98	615 820 517 0
1	4.5	0.18	50.0	1.97	615 820 687 0
2	6.0	0.24	25.4	1.00	615 820 518 0
2	6.0	0.24	50.0	1.97	615 820 519 0*
2	6.0	0.24	50.0	1.97	615 820 688 0
3	6.0	0.24	50.0	1.97	615 820 689 0

* Production upon your order.

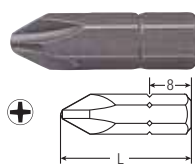

PH	LENGTH L		PART NO
	mm	in	
0	25.4	1.00	615 820 445 0*
1	25.4	1.00	615 820 446 0
2	25.4	1.00	615 820 447 0
3	25.4	1.00	615 820 448 0

* Production upon your order.

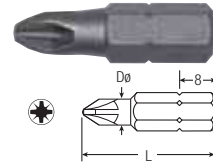

PZ	Dø		LENGTH L		PART NO
	mm	in	mm	in	
0	3.0	0.12	25.0	0.98	615 820 345 0
1	4.5	0.18	25.0	0.98	615 820 690 0
1	4.5	0.18	50.0	1.97	615 820 691 0
2	6.0	0.24	25.0	0.98	615 820 687 0
2	6.0	0.24	50.0	1.97	615 820 521 0
3	6.0	0.24	25.0	0.98	615 820 693 0

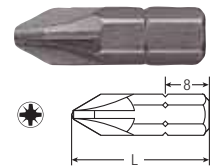

PZ	LENGTH L		PART NO
	mm	in	
1	25.4	1.00	615 820 449 0
1	50.0	1.97	615 820 520 0
2	25.4	1.00	615 820 450 0
2	50.0	1.97	615 820 521 0
3	25.4	1.00	615 820 451 0
3	50.0	1.97	615 820 522 0

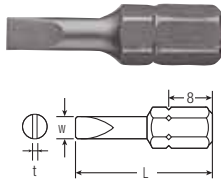

w	t	LENGTH L		PART NO	
		mm	in		
3.5	0.6	0.02	25.0	0.98	615 820 662 0
4	0.6	0.02	25.0	0.98	615 820 531 0
5	0.8	0.03	25.0	0.98	615 820 532 0
5.5	0.8	0.03	25.0	0.98	615 820 111 0

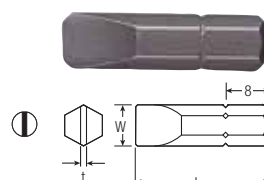

w	t	LENGTH L		PART NO	
		mm	in		
4.76	0.9	0.03	25.4	1.00	615 820 452 0
5.55	1.0	0.04	25.4	1.00	615 820 453 0
6.35	1.1	0.04	25.4	1.00	615 820 454 0
7.14	1.2	0.05	25.4	1.00	615 820 455 0
7.93	1.3	0.05	25.4	1.00	615 820 456 0

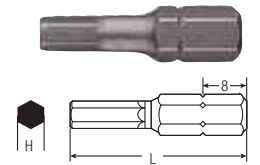

H	LENGTH L		PART NO
	mm	in	
H1.5	25.0	0.98	615 820 523 0
H2	25.0	0.98	615 820 524 0
H2.5	25.0	0.98	615 820 525 0
H3	25.0	0.98	615 820 526 0
H4	25.0	0.98	615 820 527 0
H4	33.3	1.31	615 820 457 0
H5	25.0	0.98	615 820 528 0
H5	33.3	1.31	615 820 458 0
H6	25.0	0.98	615 820 529 0
H6	33.3	1.31	615 820 459 0
H8	25.0	0.98	615 820 530 0
H8	33.3	1.31	615 820 460 0

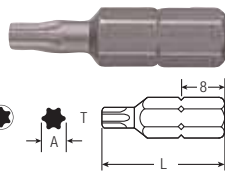

T	A	LENGTH L		PART NO	
		mm	in		
T3	1.1	0.04	25.0	0.98	615 820 686 0
T5	1.4	0.05	25.0	0.98	615 820 537 0
T6	1.7	0.06	25.0	0.98	615 820 538 0
T7	2.0	0.08	25.0	0.98	615 820 539 0
T8	2.3	0.09	25.0	0.98	615 820 540 0
T9	2.5	0.10	25.0	0.98	615 820 541 0
T10	2.7	0.11	25.0	0.98	615 820 542 0
T15	3.3	0.13	25.0	0.98	615 820 543 0
T20	3.8	0.15	25.0	0.98	615 820 544 0
T25	4.4	0.17	25.0	0.98	615 820 545 0
T27	5.0	0.20	25.0	0.98	615 820 546 0
T30	5.5	0.22	25.0	0.98	615 820 547 0
T40	6.6	0.26	25.0	0.98	615 820 548 0

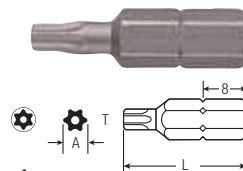

Torx Tamper Proof

T	A	LENGTH L		PART NO	
		mm	in		
T8H	2.3	0.09	25.0	0.98	615 820 112 0
T9H	2.5	0.10	25.0	0.98	615 820 113 0
T10H	2.7	0.11	25.0	0.98	615 820 549 0
T15H	3.3	0.13	25.0	0.98	615 820 550 0
T20H	3.8	0.15	25.0	0.98	615 820 551 0
T25H	4.4	0.17	25.0	0.98	615 820 552 0
T27H	5.0	0.20	25.0	0.98	615 820 553 0*
T30H	5.5	0.22	25.4	1.00	615 820 554 0

* Production upon your order.

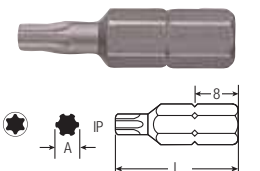

Torx Plus

IP	A	LENGTH L		PART NO	
		mm	in		
6IP	1.7	0.06	25.0	0.98	615 820 257 0
8IP	2.3	0.09	25.0	0.98	615 820 258 0
10IP	2.7	0.11	25.0	0.98	615 820 259 0
15IP	3.3	0.13	25.0	0.98	615 820 260 0
20IP	3.8	0.15	25.0	0.98	615 820 261 0
25IP	4.4	0.17	25.0	0.98	615 820 262 0
30IP	5.5	0.22	25.0	0.98	615 820 263 0
40IP	6.6	0.26	25.4	1.00	615 820 264 0

DRIVE/ 5/16" = 8mm
HEX Shank - DIN3126-C8

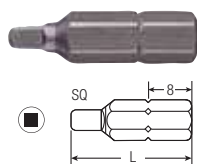

SQ	LENGTH L		PART NO
	mm	in	
1 (3/32")	25.4	1.00	615 820 461 0*
2 (1/8")	25.4	1.00	615 820 462 0
3 (9/64")	25.4	1.00	615 820 463 0

* Production upon your order.

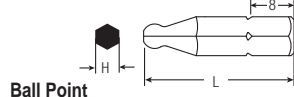

Ball Point

H	LENGTH L		PART NO
	mm	in	
H2	25.0	0.98	615 820 114 0
H2.5	25.0	0.98	615 820 115 0
H3	25.0	0.98	615 820 116 0
H4	25.0	0.98	615 820 117 0
H5	25.0	0.98	615 820 118 0
H6	25.0	0.98	615 820 119 0
H8	25.0	0.98	615 820 120 0

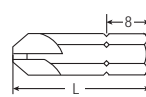

TW	LENGTH L		PART NO
	mm	in	
TW1	25.4	1.00	615 820 121 0
TW2	25.4	1.00	615 820 122 0
TW3	25.4	1.00	615 820 123 0*
TW4	25.4	1.00	615 820 124 0

* Production upon your order.

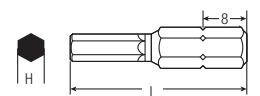

H	LENGTH L		PART NO
	mm	in	
H5	34.0	1.34	615 820 533 0
H6	34.0	1.34	615 820 534 0
H7	34.0	1.34	615 820 317 0
H8	34.0	1.34	615 820 535 0
H10	34.0	1.34	615 820 536 0

Power Bits

Drive: 1/4" = 6.35mm HEX Drive - DIN3126-E6.3

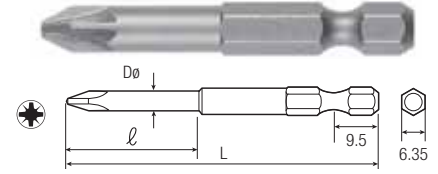
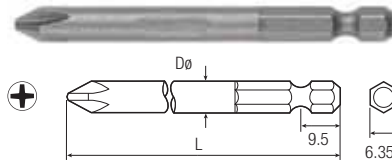
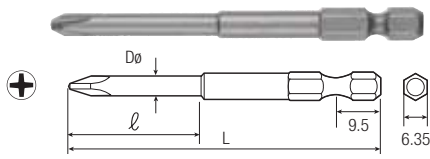

PH	Dø		l		LENGTH L		PART NO
	mm	in	mm	in	mm	in	
00	1.2	0.05	20	0.8	60	2.4	615 820 056 0
00	1.6	0.06	-	-	49	1.9	615 820 125 0
00	1.6	0.06	-	-	70	2.8	615 820 348 0
00	1.5	0.06	20	0.8	60	2.4	615 820 057 0
00	1.7	0.07	20	0.8	60	2.4	615 820 058 0
00	2	0.08	40	1.57	60	2.36	615 820 059 0
00	2.0	0.08	40	1.6	100	3.9	615 820 060 0
0	1.4	0.06	30	1.2	60	2.4	615 820 061 0
0	1.7	0.07	30	1.2	60	2.4	615 820 063 0
0	1.7	0.07	40	1.6	80	3.1	615 820 064 0
0	2.0	0.08	20	0.8	60	2.4	615 820 065 0
0	2.0	0.08	30	1.2	100	3.9	615 820 066 0
0	2.5	0.10	20	0.8	60	2.4	615 820 067 0
0	2.5	0.10	30	1.2	100	3.9	615 820 068 0
0	3.0	0.12	20	0.8	60	2.4	615 820 069 0
0	3.0	0.12	30	1.2	100	3.9	615 820 070 0
0	3.2	0.12	-	-	49	1.9	615 820 464 0

PH	Dø		LENGTH L		PART NO
	mm	in	mm	in	
1	4.8	0.19	49	1.93	615 820 465 0
1	4.8	0.19	50	1.97	615 820 706 0
1	4.76	0.19	70	2.76	615 820 466 0
1	4.76	0.19	89	3.50	615 820 467 0
1	4.76	0.19	110	4.33	615 820 707 0
1	4.5	0.18	150	5.91	615 820 659 0
1	4.76	0.19	152	5.98	615 820 468 0
2	4.76	0.19	49	1.93	615 820 126 0
2	6.35	0.25	49	1.93	615 820 469 0
2	6.0	0.24	50	1.97	615 820 708 0
2	6.35	0.25	70	2.76	615 820 470 0
2	6.35	0.25	89	3.50	615 820 471 0
2	6.0	0.24	100	3.94	615 820 561 0
2	6.0	0.24	110	4.33	615 820 709 0
2	6.0	0.24	127	5.00	615 820 127 0
2	6.0	0.24	150	5.91	615 820 660 0
2	6.35	0.25	152	5.98	615 820 472 0
2	6.0	0.24	200	7.87	615 820 129 0
3	7.9	0.31	49	1.93	615 820 473 0
3	6.0	0.24	50	1.97	615 820 710 0
3	7.9	0.31	70	2.76	615 820 474 0
3	7.9	0.31	89	3.50	615 820 475 0
3	8.0	0.31	100	3.94	615 820 562 0
3	8.0	0.31	150	5.91	615 820 128 0

PZ	Dø		l		LENGTH L		PART NO
	mm	in	mm	in	mm	in	
0	1.4	0.06	30	1.18	60	2.36	615 820 312 0
0	3.17	0.12	-	-	49	1.93	615 820 130 0
0	3.17	0.12	-	-	70	2.76	615 820 314 0
0	2.00	0.08	20	0.79	60	2.36	615 820 715 0
0	3.00	0.12	20	0.79	60	2.36	615 820 716 0
0	2.0	0.08	30	1.18	100	3.94	615 820 322 0
1	4.76	0.19	-	-	49	1.93	615 820 131 0
1	4.76	0.19	20	0.79	50	1.97	615 820 485 0
1	4.76	0.19	-	-	70	2.76	615 820 352 0
1	4.76	0.19	50	1.97	75	2.95	615 820 486 0
1	4.76	0.19	-	-	89	3.50	615 820 478 0
1	4.50	0.18	-	-	100	3.94	615 820 483 0
1	4.76	0.19	80	3.15	110	4.33	615 820 484 0
1	4.76	0.19	50	1.97	152	5.98	615 820 481 0
2	6.35	0.25	-	-	49	1.93	615 820 311 0
2	6.0	0.24	22	0.87	50	1.97	615 820 712 0
2	6.35	0.25	-	-	70	2.76	615 820 476 0
2	6.35	0.25	-	-	89	3.50	615 820 479 0
2	6.0	0.24	-	-	100	3.94	615 820 558 0
2	6.0	0.24	80	3.15	110	4.33	615 820 563 0
2	6.0	0.24	-	-	127	5.00	615 820 564 0
2	6.0	0.24	-	-	150	5.91	615 820 661 0
2	6.35	0.25	50	1.97	152	5.98	615 820 482 0
2	6.0	0.24	-	-	200	7.87	615 820 711 0
3	8.0	0.31	-	-	49	1.93	615 820 313 0
3	8.0	0.31	-	-	70	2.76	615 820 477 0
3	8.0	0.31	-	-	89	3.50	615 820 480 0
3	6.0	0.24	80	3.15	110	4.33	615 820 713 0
4	8.0	0.31	-	-	51	2.01	615 820 714 0
4	8.0	0.31	-	-	75	2.99	615 820 559 0

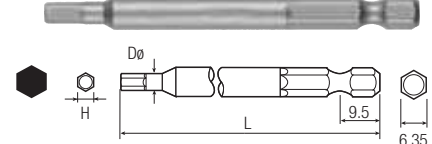
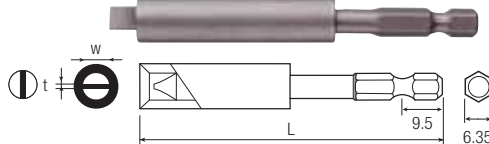
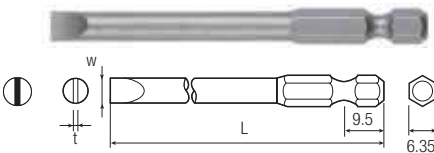

W	t	LENGTH L		PART NO	
		mm	in		
3.0	0.50	0.02	51	2.01	615 820 566 0
3.4	0.66	0.03	70	2.76	615 820 135 0
3.8	0.76	0.03	76	2.99	615 820 137 0
4.0	0.60	0.02	51	2.01	615 820 567 0
4.75	0.86	0.03	76	2.99	615 820 138 0
5.5	0.80	0.03	51	2.01	615 820 568 0
6.35	0.91	0.04	49	1.93	615 820 489 0
3.1	0.56	0.02	102	4.02	615 820 144 0
3.1	0.56	0.02	76	2.99	615 820 136 0
3.1	0.56	0.02	49	1.93	615 820 132 0
9.1	1.27	0.05	102	4.02	615 820 152 0
7.9	1.17	0.05	102	4.02	615 820 151 0
6.98	1.067	0.04	102	4.02	615 820 150 0
6.35	0.96	0.04	102	4.02	615 820 149 0
6.12	1.0	0.04	95	3.7	615 820 717 0
5.46	0.91	0.04	102	4.02	615 820 148 0
4.75	0.86	0.03	102	4.02	615 820 147 0
3.8	0.55	0.02	102	4.02	615 820 146 0
3.4	1.27	0.05	102	4.02	615 820 145 0
9.1	1.17	0.05	76	2.99	615 820 143 0
7.9	1.067	0.04	76	2.99	615 820 142 0
6.98	0.96	0.04	76	2.99	615 820 141 0
5.46	0.91	0.04	76	2.99	615 820 140 0
5.46	1.27	0.05	76	2.99	615 820 139 0
9.1	1.17	0.05	49	1.93	615 820 493 0
7.9	1.067	0.04	49	1.93	615 820 492 0
6.98	0.96	0.04	49	1.93	615 820 491 0
6.35	0.91	0.04	49	1.93	615 820 490 0
5.46	0.86	0.03	49	1.93	615 820 488 0
4.75	0.76	0.03	49	1.93	615 820 487 0
3.8	0.55	0.02	49	1.93	615 820 134 0
3.4	0.66	0.03	49	1.93	615 820 133 0

Finder Sleeve Combined

W	t	screw head	LENGTH L		PART NO	
			mm	in		
4.90	0.91	0.04	4-5	95	3.74	111062
0.91	0.91	0.04	5-6	95	3.74	615 820 503 0
6.12	0.97	0.04	6-8	95	3.74	111072
7.37	1.07	0.04	8-10	95	3.74	615 804 741 0
8.89	1.17	0.05	10-12	95	3.74	615 804 742 0
10.03	1.27	0.05	12-14	98	3.86	615 804 743 0

H	Dø		LENGTH L		PART NO
	mm	in	mm	in	
H2	7.0	0.28	75	2.95	615 820 001 0
H2	7.0	0.28	100	3.94	615 820 002 0
H2	3.5	0.14	49	1.93	615 820 353 0
H2	7.0	0.28	150	5.91	615 820 013 0
H2.5	7.0	0.28	75	2.95	615 820 003 0
H2.5	7.0	0.28	100	3.94	615 820 004 0
H2.5	7.0	0.28	150	5.91	615 820 014 0
H2.5	3.5	0.14	49	1.93	615 820 495 0
H3	3.5	0.14	49	1.93	615 820 496 0
H3	7.0	0.28	75	2.95	615 820 005 0
H3	7.0	0.28	100	3.94	615 820 006 0
H3	7.0	0.28	150	5.91	615 820 015 0
H4	4.6	0.18	49	1.93	615 820 497 0
H4	7.0	0.28	75	2.95	615 820 007 0
H4	7.0	0.28	100	3.94	615 820 008 0
H4	7.0	0.28	150	5.91	615 820 016 0
H5	5.8	0.23	49	1.93	615 820 498 0
H5	7.0	0.28	75	2.95	615 820 009 0
H5	7.0	0.28	100	3.94	615 820 010 0
H5	7.0	0.28	150	5.91	615 820 017 0
H6	-	-	49	1.93	615 820 499 0
H6	7.0	0.28	75	2.95	615 820 011 0
H6	7.0	0.28	100	3.94	615 820 012 0
H6	7.0	0.28	150	5.91	615 820 018 0
H7	10	0.39	70	2.76	615 820 569 0
H8	-	-	49	1.93	615 820 315 0
H8	10	0.39	70	2.76	615 820 570 0
H8	10	0.39	150	5.91	615 820 019 0
H9	11	0.43	70	2.76	615 820 571 0
H10	-	-	49	1.93	615 820 354 0
H10	12	0.47	70	2.76	615 820 572 0
H1/4"	-	-	49	1.93	615 820 494 0

Power Bits

Drive: 1/4" = 6.35mm HEX Drive - DIN3126-E6.3

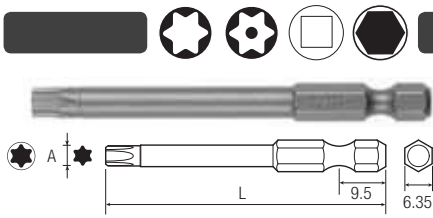

T	A		LENGTH L		PART NO
	mm	in	mm	in	
T5	1.37	0.05	49	1.93	615 820 153 0
T5	1.37	0.05	70	2.76	615 820 154 0
T5	1.37	0.05	89	3.50	615 820 155 0
T6	1.65	0.06	49	1.93	615 820 156 0
T6	1.65	0.06	70	2.76	615 820 157 0
T6	1.65	0.06	89	3.50	615 820 158 0
T6	1.65	0.06	152	5.98	615 820 159 0
T7	1.97	0.08	49	1.93	615 820 160 0
T7	1.97	0.08	70	2.76	615 820 161 0
T7	1.97	0.08	89	3.50	615 820 162 0
T7	1.97	0.08	152	5.98	615 820 165 0
T8	2.30	0.09	49	1.93	615 820 166 0
T8	2.30	0.09	70	2.76	615 820 167 0
T8	2.30	0.09	90	3.54	615 820 168 0
T8	2.30	0.09	152	5.98	615 820 169 0
T9	2.48	0.10	49	1.93	615 820 170 0
T9	2.48	0.10	70	2.76	615 820 171 0
T9	2.48	0.10	90	3.54	615 820 172 0
T9	2.48	0.10	152	5.98	615 820 176 0
T10	2.72	0.11	49	1.93	615 820 177 0
T10	2.72	0.11	70	2.76	615 820 178 0
T10	2.72	0.11	90	3.54	615 820 179 0
T10	2.72	0.11	152	5.98	615 820 180 0
T15	3.26	0.13	49	1.93	615 820 181 0
T15	3.26	0.13	70	2.76	615 820 183 0
T15	3.26	0.13	90	3.54	615 820 186 0
T15	3.26	0.13	152	5.98	615 820 187 0*
T20	3.84	0.15	49	1.93	615 820 188 0
T20	3.84	0.15	70	2.76	615 820 189 0
T20	3.84	0.15	90	3.54	615 820 190 0
T20	3.84	0.15	152	5.98	615 820 191 0
T25	4.40	0.17	49	1.93	615 820 192 0
T25	4.40	0.17	70	2.76	615 820 193 0
T25	4.40	0.17	152	5.98	615 820 316 0*
T27	4.96	0.20	49	1.93	615 820 325 0
T27	4.96	0.20	90	3.54	615 820 356 0
T27	4.96	0.20	152	5.98	615 820 695 0
T30	5.49	0.22	49	1.93	615 820 163 0
T30	5.49	0.22	70	2.76	615 820 174 0
T30	5.49	0.22	90	3.54	615 820 184 0
T30	5.49	0.22	152	5.98	615 820 194 0
T40	6.60	0.26	49	1.93	615 820 164 0
T40	6.60	0.26	70	2.76	615 820 175 0
T40	6.60	0.26	90	3.54	615 820 185 0
T40	6.60	0.26	152	5.98	615 820 195 0

* Production upon your order.

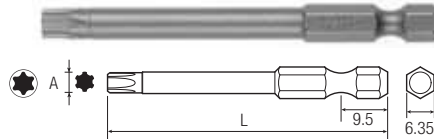

Torx Plus

IP	A		LENGTH L		PART NO
	mm	in	mm	in	
5IP	1.37	0.05	49	1.93	615 820 265 0
5IP	1.37	0.05	70	2.76	615 820 266 0
6IP	1.65	0.06	49	1.93	615 820 267 0
6IP	1.65	0.06	70	2.76	615 820 268 0
6IP	1.65	0.06	90	3.54	615 820 269 0
6IP	1.65	0.06	152	5.98	615 820 270 0
7IP	1.97	0.08	49	1.93	615 820 271 0
7IP	1.97	0.08	70	2.76	615 820 272 0
7IP	1.97	0.08	90	3.54	615 820 273 0
7IP	1.97	0.08	152	5.98	615 820 274 0
8IP	2.30	0.09	49	1.93	615 820 275 0
8IP	2.30	0.09	70	2.76	615 820 276 0
8IP	2.30	0.09	90	3.54	615 820 277 0
8IP	2.30	0.09	152	5.98	615 820 278 0
9IP	2.48	0.10	49	1.93	615 820 280 0
9IP	2.48	0.10	70	2.76	615 820 281 0*
9IP	2.48	0.10	90	3.54	615 820 286 0*
9IP	2.48	0.10	152	5.98	615 820 279 0*
10IP	2.72	0.11	49	1.93	615 820 287 0
10IP	2.72	0.11	70	2.76	615 820 288 0
10IP	2.72	0.11	90	3.54	615 820 293 0
10IP	2.72	0.11	152	5.98	615 820 294 0
15IP	3.26	0.13	49	1.93	615 820 295 0
15IP	3.26	0.13	70	2.76	615 820 296 0*
15IP	3.26	0.13	90	3.54	615 820 301 0*
15IP	3.26	0.13	152	5.98	615 820 302 0
20IP	3.84	0.15	49	1.93	615 820 303 0
20IP	3.84	0.15	70	2.76	615 820 304 0
20IP	3.84	0.15	90	3.54	615 820 305 0*
20IP	3.84	0.15	152	5.98	615 820 306 0
25IP	4.40	0.17	49	1.93	615 820 282 0*
25IP	4.40	0.17	70	2.76	615 820 283 0*
25IP	4.40	0.17	90	3.54	615 820 284 0*
25IP	4.40	0.17	152	5.98	615 820 285 0*
27IP	4.96	0.20	49	1.93	615 820 289 0
27IP	4.96	0.20	70	2.76	615 820 290 0*
27IP	4.96	0.20	90	3.54	615 820 291 0*
27IP	4.96	0.20	152	5.98	615 820 292 0*
30IP	5.49	0.22	49	1.93	615 820 297 0*
30IP	5.49	0.22	70	2.76	615 820 298 0*
30IP	5.49	0.22	90	3.54	615 820 299 0*
30IP	5.49	0.22	152	5.98	615 820 300 0
40IP	6.60	0.26	49	1.93	615 820 307 0*
40IP	6.60	0.26	70	2.76	615 820 308 0*
40IP	6.60	0.26	90	3.54	615 820 309 0*
40IP	6.60	0.26	152	5.98	615 820 310 0

* Production upon your order.

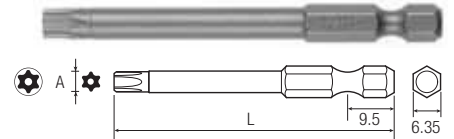

Torx Tamper Proof

T	A		LENGTH L		PART NO
	mm	in	mm	in	
T10H	2.72	0.11	49	1.93	615 820 196 0
T10H	2.72	0.11	70	2.76	615 820 198 0
T20H	3.84	0.15	49	1.93	615 820 197 0
T20H	3.84	0.15	70	2.76	615 820 199 0

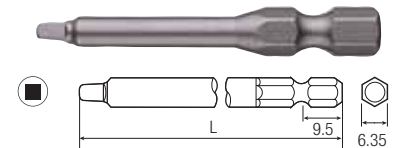

SQ	LENGTH L		PART NO
	mm	in	
1 (3/32")	70	2.76	615 820 500 0
2 (1/8")	70	2.76	615 820 501 0
3 (9/64")	70	2.76	615 820 502 0

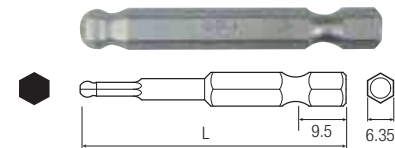

Ball Point

H	LENGTH L		PART NO
	mm	in	
H2	50	1.97	615 820 202 0
H2.5	50	1.97	615 820 203 0
H3	50	1.97	615 820 204 0
H4	50	1.97	615 820 205 0
H5	50	1.97	615 820 206 0
H6	50	1.97	615 820 207 0
H8	50	1.97	615 820 208 0

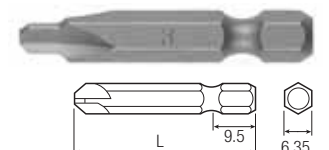

TW	LENGTH L		PART NO
	mm	in	
TW2	40	1.57	615 820 021 0
TW3	40	1.57	615 820 022 0
TW4	40	1.57	615 820 023 0
TW5	40	1.57	615 820 024 0

Nut Setters

Drive: 1/4" = 6.35mm HEX Drive - DIN3126-E6.3



Non Magnetic Nut Setters

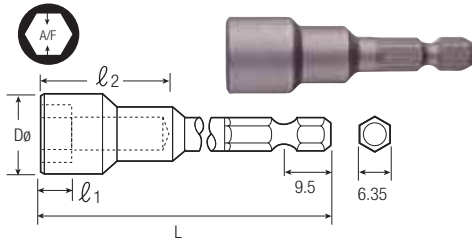

A/F		Dø		l1		l2		LENGTH L		PART NO
mm	in	mm	in	mm	in	mm	in	mm	in	10 pcs
4.0	0.2	8.0	0.3	3.0	0.1	15.0	0.6	50	2.0	615 820 573 0
4.0	0.2	8.0	0.3	3.0	0.1	25.0	1.0	75	3.0	615 820 586 0
4.0	0.2	8.0	0.3	3.0	0.1	25.0	1.0	100	3.9	615 820 599 0
4.5	0.2	8.0	0.3	3.0	0.1	15.0	0.6	50	2.0	615 820 574 0*
4.5	0.2	8.0	0.3	3.0	0.1	25.0	1.0	75	3.0	615 820 587 0*
4.5	0.2	8.0	0.3	3.0	0.1	25.0	1.0	100	3.9	615 820 600 0
5.0	0.2	8.5	0.3	3.5	0.1	15.0	0.6	50	2.0	615 820 575 0*
5.0	0.2	8.5	0.3	3.5	0.1	25.0	1.0	75	3.0	615 820 588 0
5.0	0.2	8.5	0.3	3.5	0.1	25.0	1.0	100	3.9	615 820 601 0
5.0	0.2	8.5	0.3	3.5	0.1	25.0	1.0	150	5.9	615 820 210 0
5.5	0.2	9.0	0.4	3.5	0.1	15.0	0.6	50	2.0	615 820 576 0
5.5	0.2	9.0	0.4	3.5	0.1	25.0	1.0	75	3.0	615 820 589 0
5.5	0.2	9.0	0.4	3.5	0.1	25.0	1.0	100	3.9	615 820 602 0
5.5	0.2	9.0	0.4	3.5	0.1	25.0	1.0	150	5.9	615 820 211 0
6.0	0.2	10.0	0.4	4.0	0.2	15.0	0.6	50	2.0	615 820 577 0
6.0	0.2	10.0	0.4	4.0	0.2	25.0	1.0	75	3.0	615 820 590 0
6.0	0.2	10.0	0.4	4.0	0.2	25.0	1.0	100	3.9	615 820 603 0
6.0	0.2	10.0	0.4	4.0	0.2	25.0	1.0	150	5.9	615 820 212 0
7.0	0.3	13.0	0.5	5.0	0.2	15.0	0.6	50	2.0	615 820 578 0
7.0	0.3	13.0	0.5	5.0	0.2	25.0	1.0	75	3.0	615 820 591 0
7.0	0.3	13.0	0.5	5.0	0.2	25.0	1.0	100	3.9	615 820 604 0
7.0	0.3	13.0	0.5	5.0	0.2	25.0	1.0	150	5.9	615 820 213 0
8.0	0.3	13.0	0.5	5.0	0.2	15.0	0.6	50	2.0	615 820 579 0
8.0	0.3	13.0	0.5	5.0	0.2	30.0	1.2	75	3.0	615 820 592 0
8.0	0.3	13.0	0.5	5.0	0.2	30.0	1.2	100	3.9	615 820 605 0
8.0	0.3	13.0	0.5	5.0	0.2	30.0	1.2	150	5.9	615 820 214 0
9.0	0.4	14.0	0.6	5.5	0.2	15.0	0.6	50	2.0	615 820 580 0
9.0	0.4	14.0	0.6	5.5	0.2	30.0	1.2	75	3.0	615 820 593 0
9.0	0.4	14.0	0.6	5.5	0.2	30.0	1.2	100	3.9	615 820 606 0
10.0	0.4	16.0	0.6	6.5	0.3	15.0	0.6	50	2.0	615 820 581 0
10.0	0.4	16.0	0.6	6.5	0.3	30.0	1.2	75	3.0	615 820 594 0
10.0	0.4	16.0	0.6	6.5	0.3	30.0	1.2	100	3.9	615 820 607 0
10.0	0.4	16.0	0.6	6.5	0.3	30.0	1.2	150	5.9	615 820 215 0
11.0	0.4	17.0	0.7	7.0	0.3	15.0	0.6	50	2.0	615 820 582 0
11.0	0.4	17.0	0.7	7.0	0.3	30.0	1.2	75	3.0	615 820 595 0
11.0	0.4	17.0	0.7	7.0	0.3	30.0	1.2	100	3.9	615 820 608 0
12.0	0.5	18.0	0.7	7.5	0.3	15.0	0.6	50	2.0	615 820 583 0
12.0	0.5	18.0	0.7	7.5	0.3	30.0	1.2	75	3.0	615 820 596 0
12.0	0.5	18.0	0.7	7.5	0.3	30.0	1.2	100	3.9	615 820 609 0
12.0	0.5	18.0	0.7	7.5	0.3	30.0	1.2	150	5.9	615 820 216 0
13.0	0.5	19.0	0.7	8.0	0.3	15.0	0.6	50	2.0	615 820 584 0
13.0	0.5	19.0	0.7	8.0	0.3	30.0	1.2	75	3.0	615 820 597 0
13.0	0.5	19.0	0.7	8.0	0.3	30.0	1.2	100	3.9	615 820 610 0
13.0	0.5	19.0	0.7	8.0	0.3	30.0	1.2	150	5.9	615 820 217 0
14.0	0.6	20.0	0.8	8.0	0.3	15.0	0.6	50	2.0	615 820 585 0
14.0	0.6	20.0	0.8	8.0	0.3	30.0	1.2	75	3.0	615 820 598 0
14.0	0.6	20.0	0.8	8.0	0.3	30.0	1.2	100	3.9	615 820 611 0

* Production upon your order.

Magnetic Nut Setters

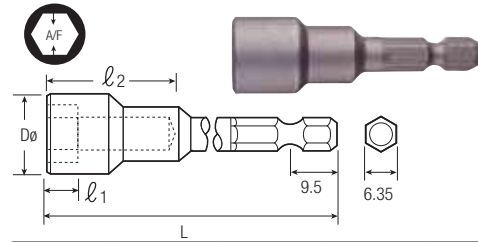

A/F		Dø		l1		LENGTH L		PART NO
mm	in	mm	in	mm	in	mm	in	10 pcs
5.0	0.2	8.5	0.3	3.5	0.1	50	2.0	615 820 612 0
5.0	0.2	8.5	0.3	3.5	0.1	75	3.0	615 820 623 0
5.0	0.2	8.5	0.3	3.5	0.1	100	3.9	615 820 634 0
5.0	0.2	8.5	0.3	3.5	0.1	150	5.9	615 820 218 0
5.5	0.2	9.0	0.4	3.5	0.1	50	2.0	615 820 613 0
5.5	0.2	9.0	0.4	3.5	0.1	75	3.0	615 820 624 0*
5.5	0.2	9.0	0.4	3.5	0.1	100	3.9	615 820 635 0*
5.5	0.2	9.0	0.4	3.5	0.1	150	5.9	615 820 219 0*
6.0	0.2	10.0	0.4	4.0	0.2	50	2.0	615 820 614 0
6.0	0.2	10.0	0.4	4.0	0.2	75	3.0	615 820 625 0
6.0	0.2	10.0	0.4	4.0	0.2	100	3.9	615 820 636 0
6.0	0.2	10.0	0.4	4.0	0.2	150	5.9	615 820 220 0
7.0	0.3	13.0	0.5	4.5	0.2	50	2.0	615 820 615 0
7.0	0.3	13.0	0.5	4.5	0.2	75	3.0	615 820 626 0
7.0	0.3	13.0	0.5	4.5	0.2	100	3.9	615 820 637 0
7.0	0.3	13.0	0.5	5.0	0.2	150	5.9	615 820 221 0
8.0	0.3	13.0	0.5	5.0	0.2	50	2.0	615 820 616 0
8.0	0.3	13.0	0.5	5.0	0.2	75	3.0	615 820 627 0
8.0	0.3	13.0	0.5	5.0	0.2	100	3.9	615 820 638 0
8.0	0.3	13.0	0.5	5.0	0.2	150	5.9	615 820 222 0
9.0	0.4	14.0	0.6	5.5	0.2	50	2.0	615 820 617 0
9.0	0.4	14.0	0.6	5.5	0.2	75	3.0	615 820 628 0
9.0	0.4	14.0	0.6	5.5	0.2	100	3.9	615 820 639 0
10.0	0.4	16.0	0.6	6.5	0.3	50	2.0	615 820 618 0
10.0	0.4	16.0	0.6	6.5	0.3	75	3.0	615 820 629 0
10.0	0.4	16.0	0.6	6.5	0.3	100	3.9	615 820 640 0
10.0	0.4	16.0	0.6	6.5	0.3	150	5.9	615 820 223 0
11.0	0.4	17.0	0.7	7.0	0.3	50	2.0	615 820 619 0
11.0	0.4	17.0	0.7	7.0	0.3	75	3.0	615 820 630 0
11.0	0.4	17.0	0.7	7.0	0.3	100	3.9	615 820 641 0
12.0	0.5	18.0	0.7	7.5	0.3	50	2.0	615 820 620 0
12.0	0.5	18.0	0.7	7.5	0.3	75	3.0	615 820 631 0
12.0	0.5	18.0	0.7	7.5	0.3	100	3.9	615 820 642 0
12.0	0.5	18.0	0.7	7.5	0.3	150	5.9	615 820 224 0
13.0	0.5	19.0	0.7	8.0	0.3	50	2.0	615 820 621 0
13.0	0.5	19.0	0.7	8.0	0.3	75	3.0	615 820 632 0
13.0	0.5	19.0	0.7	8.0	0.3	100	3.9	615 820 643 0
13.0	0.5	19.0	0.7	8.0	0.3	150	5.9	615 820 225 0
14.0	0.6	20.0	0.8	8.0	0.3	50	2.0	615 820 622 0
14.0	0.6	20.0	0.8	8.0	0.3	75	3.0	615 820 633 0
14.0	0.6	20.0	0.8	8.0	0.3	100	3.9	615 820 644 0

* Production upon your order.

Screw Shanks

Screw Shank Driver Bit



PH	M	LENGTH L		PART NO
		mm	in	10 pcs
1	M4	34	1.34	615 820 653 0
2	M4	34	1.34	615 820 654 0
2	M5	34	1.34	615 820 657 0

PZ	M	LENGTH L		PART NO
		mm	in	10 pcs
1	M4	34	1.34	615 820 655 0
2	M4	34	1.34	615 820 656 0
2	M5	34	1.34	615 820 658 0

T	M	Dø		LENGTH L		PART NO
		mm	in	mm	in	10 pcs
T10	M4	6	0.24	33	1.3	105782
T20	M4	6	0.24	33	1.3	105802
T15	M5	7	0.28	33	1.3	105842
T20	M5	7	0.28	33	1.3	105852
T25	M5	7	0.28	33	1.3	105862
T30	M5	7	0.28	33	1.3	105882

Adapters



Drive: 1/4" = 6.35mm HEX Drive - DIN3126-E6.3

PZ	LENGTH L		PART NO
	mm	in	
1/4"	35	1.38	95352
1/4"	51	2.01	615 820 508 0
1/4"	76	2.99	615 820 509 0
1/4"	102	4.02	615 820 510 0
1/4"	152	5.98	615 820 511 0
3/8"	43	1.69	95362
3/8"	51	2.01	615 820 512 0
3/8"	76	2.99	615 820 513 0
3/8"	102	4.02	615 820 514 0
3/8"	152	5.98	615 820 515 0

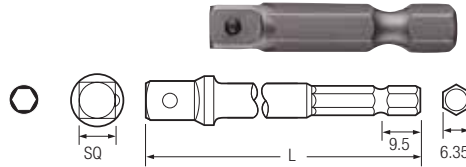

Bit Holders



Drive: 1/4" = 6.35mm HEX Drive - DIN3126-C6.3



TIP SIZE	LENGTH L		MAGNETIC	PART NO
	mm	in		
T10	33	1.30	yes	615 820 247 0
T15	33	1.30	yes	615 820 245 0
T20	33	1.30	yes	615 820 246 0
T25	33	1.30	yes	615 820 253 0
PH1	33	1.30	yes	615 820 248 0
PH2	33	1.30	yes	615 820 249 0
PZ1	33	1.30	yes	615 820 250 0
PZ2	33	1.30	yes	615 820 251 0

TIP SIZE	LENGTH L		MAGNETIC	PART NO
	mm	in		
T10	33	1.30		615 820 332 0
T10	49	1.93		615 820 340 0
T10	70	2.76		615 820 341 0
T15	33	1.30		615 820 333 0
T15	49	1.93	yes	615 820 702 0
T15	70	2.76	yes	615 820 703 0
T20	33	1.30		615 820 334 0
T20	49	1.93		615 820 342 0
T20	75	2.95		615 820 343 0

TIP SIZE	LENGTH L		MAGNETIC	PART NO
	mm	in		
T20	150	5.91		615 820 344 0
T25	33	1.30		615 820 335 0
T25	49	1.93	yes	615 820 704 0
T25	70	2.76	yes	615 820 705 0
PH1	33	1.30		615 820 336 0
PH2	33	1.30		615 820 337 0
PZ1	33	1.30		615 820 338 0
PZ2	33	1.30		615 820 339 0



PART NO	DRIVE	LENGTH L		DIAMETER Ø		MAGNETIC	DIN 3126-C6,3	DIN 3126-E6,3	DOUBLE ENDED BITS DIN 3126-E6,3	DOUBLE ENDED BITS DIN 3126-C6,3	SPECIFIC BIT
		mm	in	mm	in						
615 820 557 0	5/16"	70	2,8	12,7	0,51	Yes	X				
11502	5/16"	54	2,2	11,1	0,44	Yes	X				
615 820 556 0	5/16"	50	2,0	11,1	0,44	No	X				
615 820 443 0	1/4"	71	2,8	17	0,68	Yes	X				
615 820 444 0	1/4"	65	2,6	16	0,64	Yes	X	X	X		
615 820 404 0	1/4"	60	2,4	11,1	0,44	Yes	X				
615 820 555 0	1/4"	75	3,0	9,1	0,36	Yes			X		
110102	1/4"	150	6,0	11,1	0,44	Yes	X				
615 820 506 0	1/4"	100	4,0	11,1	0,44	Yes	X				
615 820 507 0	1/4"	150	6,0	11,1	0,44	Yes	X				
615 820 402 0	1/4"	60	2,4	11,1	0,44	No			X		
615 820 504 0	1/4"	100	4,0	11,1	0,44	No	X				
615 820 505 0	1/4"	150	6,0	11,1	0,44	No	X				
615 820 405 0	1/4"	62	2,5	14,4	0,58	Yes				X	
615 820 403 0	1/4"	62	2,5	14,4	0,58	No				X	
615 820 254 0	1/4"	49	2,0	-	-	Yes					X
615 820 255 0	1/4"	70	2,8	-	-	Yes					X
615 820 698 0	1/4"	49	2,0	-	-	Yes					X
615 820 699 0	1/4"	70	2,8	-	-	Yes					X
615 820 256 0	1/4"	49	2,0	-	-	Yes					X
615 820 244 0	1/4"	75	3,0	-	-	Yes					X
615 820 252 0	1/4"	150	6,0	-	-	Yes					X
615 820 700 0	1/4"	49	2,0	-	-	Yes					X
615 820 701 0	1/4"	70	2,8	-	-	Yes					X



Riveting & Drilling - Selection Guide

TOOL TYPE	ACCESSORIES	PAGE
RIVETING HAMMERS		160-161
		
COMPRESSION TOOLS - RIVETING		162-168
		
PISTOL GRIP DRILLS		169-172
		
STRAIGHT GRIP DRILLS		173
		
ANGLE DRILLS - Compact 90° Angle Head - Standard 90° Angle Head - Heavy Duty 90° Angle Head		174-177
		
ANGLE DRILLS - Compact 30°/45° & 360° Angle Head - Standard 360° Angle Head		178-179
		
MULTI DRILLS		180-181
		
VACUUM		182
		
TAPPERS		183
		
SPECIALITY TOOLS - Hole Deburring & Rivet Shaving - Rack Feed Drills		183-185
		
ACCESSORIES		186-189
		
ADVANCED DRILLING UNIT		190-193
		



Accessories

Model	A		B		C		D	
	mm	in.	mm	in.	mm	in.	mm	in.
CP4450-2	213	8.4	32	1.26	102	4.0	138	5.4
CP4450-3	226	8.9	32	1.26	102	4.0	138	5.4
CP4450-4	251	9.9	60	2.36	102	4.0	138	5.4
CP4475-3	275	10.8	54	2.13	180	7.1	140	5.5
CP4475-4	300	11.8	79	3.11	180	7.1	140	5.5
CP4475-6	351	13.8	130	5.12	180	7.1	140	5.5

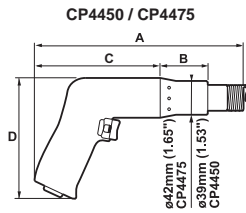

Model	A	
	mm	in.
CP4444-1	111	4.4
CP4444-RURAB	170	6.7
CP4444-RUSAB	186	7.3
CP4444-RUTAB	211	8.3
CP4447-RUSAB	227	8.9
CP4447-RUTAB	252	9.9
CP4447-RUVAB	303	11.9

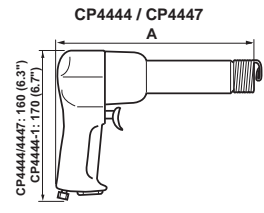

CP4444 / CP4447 / CP4450 / CP4475 / CP4450-S

ACCESSORIES INCLUDED

ITEM	CP4444-1	CP4444 CP4450	CP4447 CP4475
1 Light Wire Quick-Change Retainer	205 053 564 3	A046095	
2 Wire Quick-Change Retainer			A047095
• Blank rivet set, ø 10.2mm (.401")	205 053 565 3		

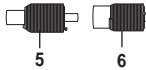
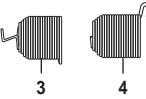
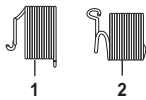

OPTIONAL ACCESSORIES

ITEM	CP4444-1	CP4444 CP4450	CP4447 CP4475
3 Zip-Quick Retainer		A046094	
4 Beehive Retainer		A046096	A047096
• Retainer for blank rivet set	205 053 566 3		
5 Nail Driving Attachment for 20-60 Penny Nail Size (for CP4447-RUSAB & CP4475)			P042448
6 Nail Driving Attachment for 12" Spikes (for CP4447-RUVAB)			P047810

CP4444 / CP4450

Type I Rivet Sets ø 10.2mm (0.401")

RIVET HEAD CUPPING	2.4mm (3/32")	3.2mm (1/8")	4.0mm (5/32")	4.8mm (3/16")	6.4mm (1/4")
• Round (AN-430)	P089206	P089207	P089208	P089209	P089210*
• Brazier (AN-455)	P089211	P089212	P089213	P089214	P089215*
• Universal (AN-470)	P089221	P089222	P089223	P089224	P089225*
• Soft Blank Set	P071108				
• Hardened Blank Set	P080178				

* Must use Light Wire Quick-Change Retainer, A046095 with these sets

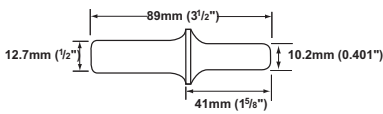

Type I Flush Rivet Sets ø 10.2mm (0.401")

	A		CP4444/4450
	mm	in	.401 SHANK
•	25.4	1"	A046090
•	31.8	1-1/4"	A089232
•	38.1	1-1/2"	A089233
•	44.5	1-3/4"	A046091

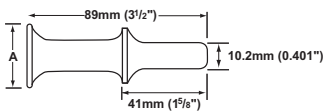

CP4447 / CP4475

Type D Rivet Sets ø 12.7mm (0.498")

RIVET HEAD CUPPING	RIVET SET PART NO. BY RIVET BODY DIA.		
	4.8mm (3/16")	6.4mm (1/4")	8mm (5/16")
• Round (AN-430)	P089240	P089241	P089242*
• Brazier (AN-455)	P089244	P089245	
• Modified Brazier (AN-456)	P089248	P089244	P089245*
• Universal (AN-470)	P089252	P089253	P089254*
• Soft Blank Set	P070995		
• Hardened Blank Set	P080198		

* Must use Light Wire Quick-Change Retainer, A047095

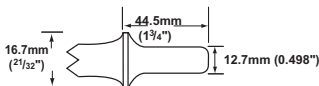

Type I Flush Rivet Sets ø 12.7mm (0.498")

	A		CP4447/4475
	mm	in	.498 SHANK
•	31.8	1-1/4"	A047091

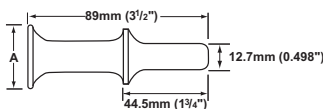

Standard & Vibration Reduced Riveting Hammers



Air inlet thread: 1/4" NPT/BSP

PIC REF	MODEL	PART NUMBER	AIRFRAME REF	BLOW PER MINUTE	BORE AND STROKE		ENERGY PER BLOW OPENING		CHISEL SHANK	RIVET CAPACITY		WEIGHT		HOSE INT. Ø	
					mm	J	ft.lb	LIGHT*		HARD**	kg	lb	mm	in.	
RIVETING HAMMERS (PISTOL GRIP) - STANDARD															
A	CP4444-1	205 147 938 4	2X (200)	2580	12.7 x 50.8mm 19/32" x 1.47"	4.4	3.2	TYPE 1 0.401"	3.2mm 1/8"	2.4mm 3/32"	1.2	2.6	10	3/8	
B	CP4444-RURAB	T022961	2X (200)	2580	12.7 x 50.8mm 1/2" x 2"	4.0	2.9	TYPE 1 0.401"	3.2mm 1/8"	2.4mm 3/32"	1.0	2.2	10	3/8	
B	CP4444-RUSAB	T022962	3X (300)	2160	12.7 x 76.2mm 1/2" x 3"	6.1	4.5	TYPE 1 0.401"	4.8mm 3/16"	4.0mm 5/32"	1.1	2.3	10	3/8	
B	CP4444-RUTAB	T022963	4X (400)	1740	12.7 x 101.6mm 1/2" x 4"	8.1	6.0	TYPE 1 0.401"	6.4mm 1/4"	4.8mm 3/16"	1.3	2.7	10	3/8	
C	CP4447-RUSAB	T022965	5XB (500)	1560	19.1 x 68.3mm 3/4" x 2-11/16"	12.3	9.1	TYPE D 0.498"	6.4mm 1/4"	4.8mm 3/16"	2.2	4.7	10	3/8	
C	CP4447-RUTAB	T022912	7XB (700)	1140	19.1 x 98.4mm 3/4" x 3-7/8"	17.8	13.1	TYPE D 0.498"	7.9mm 5/16"	6.4mm 1/4"	2.3	5.1	10	3/8	
C	CP4447-RUVAB	T022964	9XB (800)	900	19.1 x 147.6mm 3/4" x 5-13/16"	26.6	19.6	TYPE D 0.498"	9.5mm 3/8"	7.9mm 5/16"	2.7	9.0	10	3/8	
RIVETING HAMMERS (PISTOL GRIP) - VIBRATION REDUCED															
D	CP4450-2	T025189	2X (200)	2580	12.7 x 50.8mm 1/2" x 2"	4.0	2.9	TYPE 1 0.401"	3.2mm 1/8"	2.4mm 3/32"	1.2	2.7	10	3/8	
D	CP4450-3	T025190	3X (300)	2160	12.7 x 76.2mm 1/2" x 3"	6.1	4.5	TYPE 1 0.401"	4.8mm 3/16"	4.0mm 5/32"	1.3	2.8	10	3/8	
D	CP4450-4	T025191	4X (400)	1740	12.7 x 101.6mm 1/2" x 4"	8.1	6.0	TYPE 1 0.401"	6.4mm 1/4"	4.8mm 3/16"	1.5	3.2	10	3/8	
E	CP4475-3	T025241	5XB (500)	2000	19.1 x 76.2mm 3/4" x 3"	13.7	10.1	TYPE D 0.498"	6.4mm 1/4"	4.8mm 3/16"	1.8	3.9	10	3/8	
E	CP4475-4	T025242	7XB (700)	1700	19.1 x 101.6mm 3/4" x 4"	18.3	13.5	TYPE D 0.498"	7.9mm 5/16"	6.4mm 1/4"	2.4	5.3	10	3/8	
E	CP4475-6	T025243	9XB (800)	1250	19.1 x 152.4mm 3/4" x 6"	27.5	20.3	TYPE D 0.498"	9.5mm 3/8"	7.9mm 5/16"	2.8	6.2	10	3/8	

* LIGHT: Aluminium 2017 / 2117 (DCJ-DXJ / D-AD). ** HARD: Aluminium 7050 (DKJ / KE / E) (M) (T)

Compression Tools – Riveting – Selection



CP0214 – C Yoke

- Single and Tandem cylinder options
- Riveting Capacity –
 - ø 3.2mm (1/8") (single cylinder)
 - ø 4.8mm (3/16") (tandem cylinder)
- Lock-off throttle – reduces the risk of accidental operation



CP0341 – C Yoke

- Patented 'Pneudraulic™' air-hydraulic riveter
- Riveting Capacity –
 - ø 7.14mm (9/32")
- Lock-off throttle – reduces the risk of accidental operation
- Versatile – can accommodate various rivet lengths and joint thickness through the adjustment of air pressure (reducing setting times and eliminating the need to use set length spacer shims with the rivet sets)



CP0351 – C Yoke

- Single and Tandem cylinder options
- Riveting Capacity –
 - ø 4.8mm (3/16") (single cylinder)
 - ø 6.4mm (1/4") (tandem cylinder)
- Actuation throttle guard – reduces the risk of accidental operation
- Short stroke adjustment – aids positioning of the tool (limits the return travel of the moving set of the tool on the rivet to reduce the starting clearance between rivet and rivet sets)



CP0214 – Alligator Jaw

- Single and Tandem cylinder options
- Riveting Capacity –
 - ø 3.2mm (1/8") (single cylinder)
 - ø 4.8mm (3/16") (tandem cylinder)
- Lock-off throttle – reduces the risk of accidental operation



CP0351 – Alligator Jaw

- Single and Tandem cylinder options
- Riveting Capacity –
 - ø 4.0mm (5/32") (single cylinder)
 - ø 6.4mm (1/4") (tandem cylinder)
- Actuation throttle guard – reduces the risk of accidental operation
- Short stroke adjustment – aids positioning of the tool (limits the return travel of the moving set of the tool on the rivet to reduce the starting clearance between rivet and rivet sets)

Selection Criteria

- **Type of Rivet**
 - Rivet material
 - Rivet body diameter
 - Rivet length before and after compression
 - Force required to compress rivet (if known)
- **What material is the rivet made from?**
- **What size is the rivet?**
- **What is the form of the rivet head?**
- **Components to assemble**
 - Access to rivet on assembly

- **Open access (up to 54mm (2 1/8") reach)**

– 'C' Yoke tool

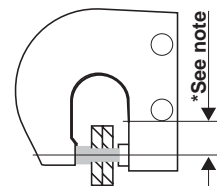

- **Restricted access (up to 232mm (9 1/8") reach)**

– 'Alligator' Jaw tool

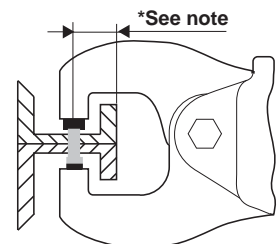

• **Note:** the amount of reach required is determined by the distance from the rivet centerline to the accessible edge of the workpiece

Compression Tools – Riveting – Selection

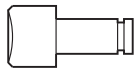

Compression Rivet Sets

(Complete with retaining rings)

Minimum Order: 6 of any part number

Note: The illustration above shows one rivet set. Two rivet sets are required to be used per tool. Part numbers are for one rivet set only.

SELECTING RIVET SETS TO FIT CP0214, CP0341 and CP0351 RIVETERS

To develop maximum power, the riveter must drive (set) the rivet at the end of the riveter's stroke (with the exception of the CP0341 which develops max power throughout its full stroke).

For maximum power the combined length of the two rivet sets must be of the correct length.

Determine the correct lengths as follows:

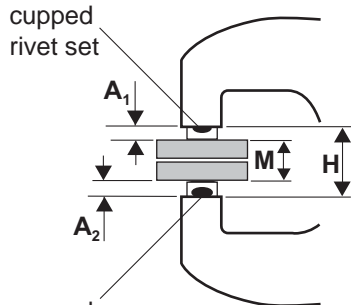

$$A_1 + A_2 = H - M$$

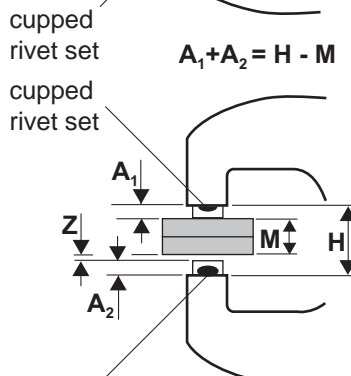

$$A_1 + A_2 = H - M - Z$$

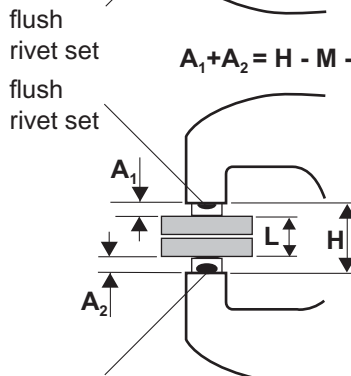

$$A_1 + A_2 = H - L$$

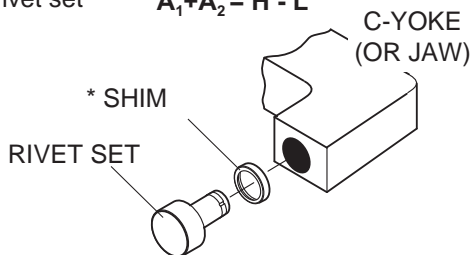

1) When two cupped rivet sets are used:

The length of the body dimensions of the rivet sets (A1, A2) should equal the closed height dimension of the yoke (H) minus the total thickness of material being riveted together.

2) When one cupped set and one flush set are used:

The length of the body dimensions of the two rivet sets (A1, A2) should equal the closed height dimension of the yoke (H) minus the total thickness of the material being riveted (M) and the height of the finished rivet head (Z) compressed by the flush set (A).

3) When two flush sets are used:

The length of the body dimensions of the two rivet sets (A1, A2) should equal the closed height dimension of the yoke (H) minus the overall length of the rivet (L) after it is compressed.

If necessary, select rivet sets a little short and shim to the correct length using spacer shims.

* Set Length Spacer Shims

TYPE RIVET SET SHANK	PART NUMBERS OF HARDENED SHIMS		
	0.4mm thick (1/64")	0.8mm thick (1/32")	1.6mm thick (1/16")
CR-1	P083254	P083255	P083256
CR-2		P083257	P083258

Compression Tools – Technical Data

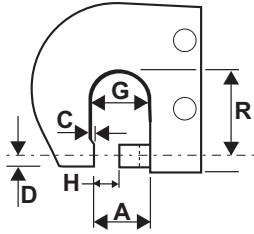

Jaw and Yoke Terminology:
(rivet sets are not in place in this illustration)

- A** Throat gap
- C** Anvil work clearance
- D** Lower offset
- G** Total yoke gap
- H** Closed height
- R** Reach

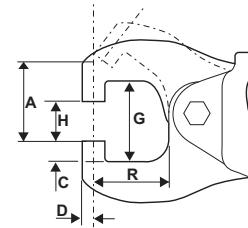

C Yoke Model	A		C		D		G		H		R	
	mm	in.	mm	in.	mm	in.	mm	in.	mm	in.	mm	in.
CP0214CELEL	32	1-1/4	-	-	5	3/16	32	1-1/4	17.5	11/16	38	1-1/2
CP0214FALEL	32	1-1/4	-	-	5	3/16	32	1-1/4	17.5	11/16	38	1-1/2
CP0214SETEL	32	1-1/4	-	-	6.4	1/4	32	1-1/4	17.5	11/16	38	1-1/2
CP0214KETEL	32	1-1/4	-	-	6.4	1/4	32	1-1/4	17.5	11/16	38	1-1/2
CP0351CUDEL	39	1-17/32	-	-	5.5	7/32	29	1-5/32	20	25/32	54	2-1/8
CP0351FUDEL	39	1-17/32	-	-	5.5	7/32	29	1-5/32	20	25/32	54	2-1/8
CP0341CUDEL	57	2-1/4	3	1/8	9	11/32	70	2-3/4	25	1	54	2-1/8

C Yoke Model	A		C		D		G		H		R	
	mm	in.	mm	in.	mm	in.	mm	in.	mm	in.	mm	in.
CP0214ANGEL	54	2-1/8	-	-	5.5	7/32	54	2-1/8	22	7/8	76	3
CP0214ENGEL	54	2-1/8	-	-	5.5	7/32	54	2-1/8	22	7/8	76	3
CP0214ANFEL	48	1-7/8	-	-	5.5	7/32	54	2-1/8	22	7/8	57	2-1/4
CP0214ENFEL	48	1-7/8	-	-	5.5	7/32	54	2-1/8	22	7/8	57	2-1/4
CP0214ANBEL	38	1-1/2	-	-	5.5	7/32	41	1-5/8	22	7/8	38	1-1/2
CP0214ENBEL	38	1-1/2	-	-	5.5	7/32	41	1-5/8	22	7/8	38	1-1/2
CP0351ASVEL	62	2-7/16	-	-	5.5	7/32	56	2-3/16	19	3/4	232	9-1/8
CP0351ESVEL	62	2-7/16	-	-	5.5	7/32	56	2-3/16	19	3/4	232	9-1/8
CP0351ESREL	81	3-3/16	-	-	5.5	7/32	51	2	38	1-1/2	178	7
CP0351ASKEL	57	2-1/4	-	-	5.5	7/32	41	1-5/8	22	7/8	127	5
CP0351ESKEL	57	2-1/4	-	-	5.5	7/32	41	1-5/8	22	7/8	127	5
CP0351ASGEL	38	1-1/2	-	-	5.5	7/32	41	1-5/8	22	7/8	73	2-7/8
CP0351ESGEL	38	1-1/2	-	-	5.5	7/32	41	1-5/8	22	7/8	73	2-7/8

Air inlet: 1/4" NPTF

MODEL	CYLINDER TYPE	RIVET SET TYPE	LENGTH		WEIGHT		SOUND LEVEL	SOUND POWER
			mm	in.	kg	lb		
CP0214ANBEL	Single	CR-1 (ø 4.8mm 3/16")	233	9-3/16	1.7	3-3/4	90	101
CP0214ANFEL	Single	CR-1 (ø 4.8mm 3/16")	254	10	1.9	4-1/4	90	101
CP0214ANGEL	Single	CR-1 (ø 4.8mm 3/16")	273	10-3/4	2.0	4-1/2	90	101
CP0214CELEL	Single	CR-1 (ø 4.8mm 3/16")	262	10-5/16	2.0	4-1/2	90	101
CP0214ENBEL	Tandem	CR-1 (ø 4.8mm 3/16")	303	11-15/16	2.2	4-3/4	90	101
CP0214ENFEL	Tandem	CR-1 (ø 4.8mm 3/16")	324	12-3/4	2.4	5-1/4	90	101
CP0214ENGEL	Tandem	CR-1 (ø 4.8mm 3/16")	343	13-1/2	2.5	5-1/2	90	101
CP0214FALEL	Tandem	CR-1 (ø 4.8mm 3/16")	356	14	2.5	5-1/2	90	101
CP0214KETEL	Tandem	CR-2 (ø 6.4mm 1/4")	356	14	2.5	5-1/2	90	101
CP0214SETEL	Single	CR-2 (ø 6.4mm 1/4")	262	10-5/16	2.0	4-1/2	90	101
CP0341CUDEL	Pneudraulic™	CR-2 (ø 6.4mm 1/4")	505	19-7/8	6.1	13-1/2	85	-
CP0351ASGEL	Single	CR-1 (ø 4.8mm 3/16")	495	19-1/2	7.1	15-3/4	96	107
CP0351ASKEL	Single	CR-1 (ø 4.8mm 3/16")	549	21-5/8	9.0	19-3/4	96	107
CP0351ASVEL	Single	CR-1 (ø 4.8mm 3/16")	654	25-3/4	11.9	26-1/4	96	106
CP0351CUDEL	Single	CR-1 (ø 4.8mm 3/16")	445	17-1/2	5.7	12-1/2	96	107
CP0351ESGEL	Tandem	CR-1 (ø 4.8mm 3/16")	603	23-3/4	8.4	18-1/2	96	107
CP0351ESKEL	Tandem	CR-1 (ø 4.8mm 3/16")	657	25-7/8	10.2	22-1/2	96	107
CP0351ESREL	Tandem	CR-1 (ø 4.8mm 3/16")	708	27-7/8	12.2	27	96	107
CP0351ESVEL	Tandem	CR-1 (ø 4.8mm 3/16")	762	30	13.2	29	96	107
CP0351FUDEL	Tandem	CR-1 (ø 4.8mm 3/16")	552	21-3/4	6.9	15-1/4	96	107
CP0351PU	Single	n/a	546	21-1/2	9.3	20-1/2	96	107
CP0351CABHDY	Single	n/a	445	17-1/2	9.2	20-5/16	96	107

Compression Tools – Riveting



For applications requiring the special 'Alligator Jaws or C-Yokes'



Alligator Jaws mounting versions



C Yoke mounting versions

PART NUMBER	MODEL	ÉQUIVALENT STANDARD MODEL
T019138	CP0214ANPEL	CP0214ANBEL/ANFEL/ANGEL without jaws
T018997	CP0214ENPEL	CP0214ENBEL/ENFEL/ENGEL without jaws
T025405	CP0351ASNEL	CP0351ASKEL without jaws

PART NUMBER	MODEL	ÉQUIVALENT STANDARD MODEL
T018677	CP0214CENEL	CP0214CELEL without yoke
T018430	CP0214FANEL	CP0214FALEL without yoke
T022493	CP0341CUNEL	CP0341CUDEL without yoke
T007772	CP0351CUNEL	CP0351CUDEL without yoke

*CR1 **CR2

PIC REF	MODEL	PART NUMBER	CAPACITY				STANDARD YOKE DIMENSIONS				MAX FORCE		MOVING PLUNGER			
			ALUM.		STEEL		REACH		CLOSED HEIGHT		(90 psi/6.2 bar)		MAX. TRAVEL		FINAL PART OF STROKE AT MAX. FORCE	
			mm	in.	mm	in.	mm	in.	mm	in.	kN	lb	mm	in.	mm	in.
C-Yoke (single cylinder)																
A	CP0214CELEL*	T012344	3.2	1/8	2.4	3/32	38.1	1-1/2	17.5	11/16	13.35	3,000	14.3	9/16	1.3	0.050
A	CP0214SETEL**	T023474	3.2	1/8	2.4	3/32	38.1	1-1/2	17.5	11/16	13.35	3,000	14.3	9/16	1.3	0.050
B	CP0351CUDEL*	T008955	4.8	3/16	4.0	5/32	54.0	2-1/8	19.8	25/32	26.70	6,000	14.3	9/16	3.2	0.125
C-Yoke (tandem cylinder)																
A	CP0214FALEL*	T013152	4.8	3/16	4.0	5/32	38.1	1-1/2	17.5	11/16	26.70	6,000	14.3	9/16	1.6	0.063
A	CP0214KETEL**	T023475	4.8	3/16	4.0	5/32	38.1	1-1/2	17.5	11/16	26.70	6,000	14.3	9/16	1.6	0.063
B	CP0351FUDEL*	T012608	6.4	1/4	5.6	7/32	54.0	2-1/8	19.8	25/32	53.40	12,000	14.3	9/16	3.2	0.125
C-Yoke (pneudraulic™)																
D	CP0341CUDEL**	T022512	7.1	9/32	6.4	1/4	54.0	2-1/8	25.4	1	60.10	13,500	31.8	1-1/4	Full stroke	
Alligator (single cylinder)																
C	CP0214ANBEL*	T012343	3.2	1/8	2.4	3/32	38.1	1-1/2	22.2	7/8	13.35	3,000	15.9	5/8	1.3	0.050
C	CP0214ANFEL*	T018671	2.4	3/32	2.4	3/32	57.1	2-1/4	22.2	7/8	9.79	2,200	22.2	7/8	2.4	0.094
C	CP0214ANGEL*	T018672	2.4	3/32	1.6	1/16	76.2	3	22.2	7/8	8.01	1,800	31.8	1-1/4	1.4	0.056
E	CP0351ASGEL*	T007783	4.0	5/32	3.2	1/8	73.0	2-7/8	22.2	7/8	23.14	5,200	15.9	5/8	3.2	0.125
E	CP0351ASKEL*	T007773	3.2	1/8	2.4	3/32	127.0	5	22.2	7/8	15.13	3,400	34.0	1-3/8	4.8	0.188
E	CP0351ASVEL*	T009582	3.2	1/8	2.4	3/32	232.0	9-1/8	19.1	3/4	13.35	3,000	42.9	1-11/16	1.6	0.063
Alligator (tandem cylinder)																
C	CP0214ENGEL*	T018164	3.2	1/8	2.4	3/32	76.2	3	22.2	7/8	15.13	3,400	31.8	1-1/4	2.6	0.104
C	CP0214ENFEL*	T018163	4.0	5/32	3.2	1/8	57.1	2-1/4	22.2	7/8	19.14	4,300	22.2	7/8	2.4	0.094
C	CP0214ENBEL*	T018678	4.8	3/16	4.0	5/32	38.1	1-1/2	22.2	7/8	26.70	6,000	15.9	5/8	1.6	0.06
E	CP0351ESKEL*	T012603	4.8	3/16	4.0	5/32	127.0	5	22.2	7/8	30.26	6,800	34.0	1-3/8	4.8	0.188
E	CP0351ESREL*	T012604	4.8	3/16	4.0	5/32	178.0	7	38.1	1-1/2	26.70	6,000	42.9	1-11/16	4.8	0.188
E	CP0351ESVEL*	T012605	4.8	3/16	4.0	5/32	232.0	9-1/8	19.1	3/4	26.70	6,000	42.9	1-11/16	1.6	0.063
E	CP0351ESGEL*	T012602	6.4	1/4	4.8	3/16	73.0	2-7/8	22.2	7/8	46.28	10,400	15.9	5/8	3.2	0.125

Compression Tools – Riveting – Rivet Sets

RIVET DIAMETER		'A' BODY LENGTH		AN-435 BUTTON	AN-430 ROUND	AN-455 BRAZIER	AN-456 MODIFIED BRAZIER	AN-470 UNIVERSAL	AN-442 FLAT
mm	in.	mm	in.	part no.	part no.	part no.	part no.	part no.	part no.

CR-1 SHANK RIVET SETS FOR CP0214 and CP0351 – CUPPED SETS

(C-Yoke tools – CP0214 CELEL, FALEL, CUDEL, FUEL + all Alligator Yoke tools)

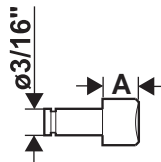

2.4	3/32"	6.4	1/4"	P091601	P089370	P089390	P089410	P089430	P091621
2.4	3/32"	9.5	3/8"	P091602	P089371	P089391	P089411	P089431	P091622
2.4	3/32"	12.7	1/2"	–	–	–	P089412	P089432	P091623
3.2	1/8"	6.4	1/4"	P091606	P089375	P089395	P053826	P089435	P091626
3.2	1/8"	9.5	3/8"	P091607	P089376	–	P053827	P089436	P091627
3.2	1/8"	12.7	1/2"	P091608	P089377	P089397	–	P089437	P091628
4.0	5/32"	6.4	1/4"	P091611	P089380	P089400	P053831	P089440	P091631
4.0	5/32"	9.5	3/8"	P091612	P089381	P089401	P053832	P089441	P091632
4.0	5/32"	12.7	1/2"	P091613	P089382	P089402	P053833	P089442	P091633
4.8	3/16"	6.4	1/4"	P091616	P089385	P089405	P053836	P089445	P091636
4.8	3/16"	9.5	3/8"	P091617	P089386	P089406	P053837	P089446	P091637
4.8	3/16"	12.7	1/2"	P091618	P089387	P089407	P053838	P089447	P091638

CR-2 SHANK RIVET SETS FOR CP0214 and CP0341 – CUPPED SETS

(C-Yoke tools – CP0214 SETEL, KETEL + CP0341 CUDEL)

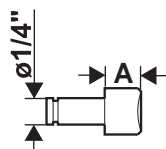

3.2	1/8"	6.4	1/4"	–	–	–	–	P089510	P091661
3.2	1/8"	9.5	3/8"	P091642	–	–	–	P089511	–
3.2	1/8"	12.7	1/2"	–	–	–	–	P089512	P091663
4.0	5/32"	6.4	1/4"	–	P089455	–	–	P089515	–
4.0	5/32"	9.5	3/8"	–	–	–	–	P089516	P091667
4.0	5/32"	12.7	1/2"	P091648	–	–	–	P089517	P091668
4.8	3/16"	6.4	1/4"	–	P089460	P089480	–	P089520	P091671
4.8	3/16"	9.5	3/8"	–	P089461	P089481	–	P089521	P491672
4.8	3/16"	12.7	1/2"	P091653	–	P089482	–	P089522	P091673
6.4	1/4"	6.4	1/4"	–	P089465	P089485	–	P089525	P091676
6.4	1/4"	9.5	3/8"	–	P089466	P089486	–	P089526	–
6.4	1/4"	12.7	1/2"	–	P089467	–	–	P089527	P091678

SHANK SIZE	'A' BODY LENGTH					
	3.2mm (1/8")	6.4mm (1/4")	9.5mm (3/8")	12.7mm (1/2")	15.8mm (5/8")	19mm (3/4")

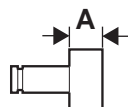

FLUSH SETS for any rivet size

CR-1 (ø 4.8mm 3/16")	P089495	P089496	P089497	P089498	P089499	P089500
CR-2 (ø 6.4mm 1/4")	–	P089501	P089502	P089503	P089504	P089505

TYPE OF RIVET SET SHANK	'A' LENGTH		BODY DIAMETER		PART NUMBER
	mm	in.	mm	in.	

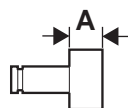

SOFT SET BLANKS

CR-1 (ø 4.8mm 3/16")	19.1	3/4"	15.9	5/8"	P093672
CR-2 (ø 6.4mm 1/4")	19.1	3/4"	19.1	3/4"	P093673

SET LENGTH SPACER SHIMS

TYPE RIVET SET SHANK	PART NUMBERS OF HARDENED SHIMS		
	0.4mm (1/64")	0.8mm (1/32")	1.6mm (1/16")
CR-1	P083254	P083255	P083256
CR-2		P083257	P083258

RIVET SET RETAINER RING

TYPE RIVET SET SHANK	PART NUMBER
CR-1	P071916
CR-2	P071917

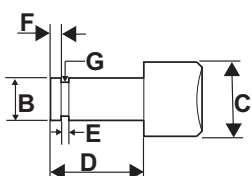

* 'C' dimension is for flush set only. 'C' varies on cupped sets according to rivet size and type of head.

TYPE OF RIVET SET SHANK	B		C*		D		E		F		G	
	mm	in.	mm	in.	mm	in.	mm	in.	mm	in.	mm	in.

SHANK DIMENSIONS FOR RIVET SETS

For CP0214, CP0351 and CP0341 Compression Riveters

CR-1 (ø 4.8mm 3/16")	4.72-4.75	0.186-0.187	12.7	1/2	12.7	1/2	3.38-3.45	0.133-0.136	1.6	1/16	3.12-3.23	0.123-0.127
CR-2 (ø 6.4mm 1/4")	6.40-6.42	0.248-0.249	15.9	5/8	15.9	5/8	3.38-3.45	0.133-0.136	2.4	3/32	4.70-4.80	0.185-0.189

Compression Tools – Rivet Sizes (Reference)

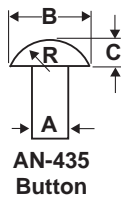

A		B		C		R	
mm	in.	mm	in.	mm	in.	mm	in.
AN-435 A.S.A. BUTTON							
2.4	3/32"	4.22	0.166	1.78	0.070	2.13	0.084
3.2	1/8"	5.56	0.219	2.39	0.094	2.82	0.111
4.0	5/32"	6.93	0.273	4.32	0.117	3.51	0.138
4.8	3/16"	8.33	0.328	3.58	0.141	4.22	0.166
6.4	1/4"	11.10	0.437	4.78	0.188	5.61	0.221
7.9	5/16"	13.87	0.546	5.94	0.234	7.01	0.276

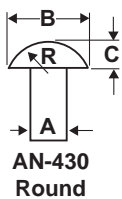

A		B		C		R	
mm	in.	mm	in.	mm	in.	mm	in.
AN-430 ROUND							
2.4	3/32"	4.75	0.187	1.78	0.070	2.49	0.098
3.2	1/8"	6.45	0.250	2.39	0.094	3.30	0.130
4.0	5/32"	7.92	0.312	2.97	0.117	4.11	0.162
4.8	3/16"	9.53	0.375	3.58	0.141	4.95	0.195
6.4	1/4"	12.70	0.500	4.78	0.188	6.60	0.260
7.9	5/16"	16.46	0.648	5.94	0.234	8.26	0.325

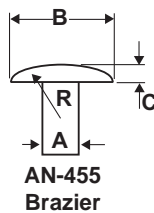

A		B		C		R	
mm	in.	mm	in.	mm	in.	mm	in.
AN-455 BRAZIER							
2.4	3/32"	5.94	0.234	1.19	0.047	4.32	0.170
3.2	1/8"	7.92	0.312	1.60	0.063	5.74	0.226
4.0	5/32"	9.90	0.390	1.98	0.078	7.19	0.283
4.8	3/16"	11.89	0.468	2.39	0.094	8.64	0.340
6.4	1/4"	15.83	0.625	3.18	0.125	11.51	0.453
7.9	5/16"	19.84	0.781	3.96	0.156	14.35	0.565

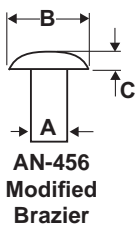

A		B		C	
mm	in.	mm	in.	mm	in.
AN-456 MODIFIED BRAZIER					
2.4	3/32"	3.96	0.156	0.79	0.031
3.2	1/8"	5.97	0.235	1.19	0.047
4.0	5/32"	7.92	0.312	1.60	0.063
4.8	3/16"	9.91	0.390	1.98	0.078
6.4	1/4"	11.89	0.468	2.39	0.094
7.9	5/16"	15.88	0.625	3.18	0.125

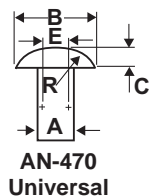

A		B		C		R		E	
mm	in.	mm	in.	mm	in.	mm	in.	mm	in.
AN-470 UNIVERSAL									
2.4	3/32"	4.75	0.187	1.04	0.041	2.08	0.082	1.19	0.047
3.2	1/8"	6.45	0.250	1.37	0.054	2.74	0.108	1.60	0.063
4.0	5/32"	7.92	0.312	1.70	0.067	3.43	0.135	1.98	0.078
4.8	3/16"	9.53	0.375	2.08	0.082	4.17	0.164	2.39	0.094
6.4	1/4"	12.70	0.500	2.72	0.107	5.51	0.217	3.18	0.125
7.9	5/16"	16.46	0.648	3.45	0.136	6.91	0.272	3.96	0.156

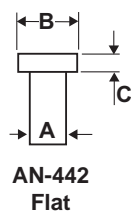

A		B		C	
mm	in.	mm	in.	mm	in.
AN-442 FLAT					
2.4	3/32"	4.75	0.187	0.94	0.037
3.2	1/8"	6.45	0.250	1.27	0.050
4.0	5/32"	7.92	0.312	1.57	0.062
4.8	3/16"	9.53	0.375	1.91	0.075
6.4	1/4"	12.70	0.500	2.54	0.100
7.9	5/16"	16.46	0.648	3.18	0.125

Compression Tools – Sheet Metal Punch



CP0351-PU

- **Punching Capacity:**
 - ø 4.8mm (3/16") in aluminum
 - through 4.8mm (3/16") material thickness
- **Actuation throttle guard:**
 - reduces the risk of accidental operation
- Use for a wide range of punching operations where it is preferable to take the tool to the job.
 - e.g. large structures such as truck trailers

Capacity:

Maximum hole is ø 13mm (1/2") relative to material and thickness.

Within maximum force of 24.0 kN – 5,400 lbs, material thickness should not exceed hole diameter.

To determine force required use formula: $F = 3.14 \times D \times T \times S$

where 'F' is force (lbs); 'D' is hole diameter (in.); 'T' is thickness of material (in.); 'S' is tensile strength of material (psi) or 'F' is force (kN); 'D' is hole diameter (mm); 'T' is thickness of material (mm); 'S' is tensile strength of material (N/mm²).

Accessories supplied with tool

HOLE SIZE IN ALUMINUM	PUNCH	DIE	COLLAR
ø 4.8mm (3/16")	P041307	P043009	P041309
ø 5.2mm (13/64")	P112836	P112837	P112838

MODEL	PART NUMBER	MAX. MATERIAL THICKNESS ALUM.		HOLE DIAMETER		MAX. DISTANCE EDGE OF SHEET TO HOLE CENTRELINE		MAX. PUNCHING FORCE (90 psi/6.2 bar)		WORK CLEARANCE PUNCH RETRACTED	
		mm	in.	mm	in.	mm	in.	kN	lb	mm	in.
CP0351PU	205 146 721 4	4.8	3/16	5.2	13/64	47.6	1-7/8	24.0	5400	12.7	1/2

Compression Tools – Edge Former

CP0351-CABH-DY

- Forming Capacity (max material thickness) – ø 6.4mm (1/4")
- Rotary Suspension Bail fitted – eases handling and orientation of tool
- Use for a wide range of flattening of spot welded flanges and removing bends
- Custom yokes and dies can be used for crimping and staking operations
- Automatic cycling frequency is adjustable from 1 cycle per throttle actuation to up to 200 cycles per minute whilst the throttle actuation is maintained.



Accessories supplied with tool

	PART NUMBER
• Yoke	P059557
• Die	P059556
• Ball bearing Suspension Bail	P102451

MODEL	PART NUMBER	MAX. MATERIAL THICKNESS ALUM.		MAX. CYCLES PER MINUTE	REACH		MAX. COMPRESSIVE FORCE (90 psi/6.2 bar)	
		mm	in.		mm	in.	kN	lb
CP0351-CABH-DY	T020475	6.4	1/4	200	14.4	9/16	26.7	6000

Drills – Selection Guide

High power - Durable: long life - High precision - Ergonomic



Choosing the right Drill

Pistol Grip Drills

- Ideal for all general industrial drilling tasks
- Drilling capacity up to 13mm (1/2") Ø steel
- Best ergonomic shape - single and double handed use
- Use of side handle recommended for larger drills with high torque reaction



Straight Drills

- Mainly smaller diameter drilling less than 10mm (3/8") Ø Steel
- Favoured for vertical drilling
- Suitable for production line repetitive operations



Angle Drills

- Most commonly used in aerospace
- Ideal for restricted access applications
- Drill capacity up to 8mm (5/16") Ø steel

Choosing the right Chuck

Key Adjustable Chuck

- Ideal for all general industrial drilling tasks
- High precision keyed chucks

Keyless Chucks

- Quick change (hand operated) chuck

Collet Chuck / Spindle





- Generally high speed drilling
- High precision
- Most commonly used in aerospace

Screw Shank

- Female threaded output
- Use with threaded shank drills
- Most commonly used in aerospace

How to select your tool:

- ① Select material - ② Select hole size - ③ Define speed

TOOL TYPE	FREE SPEED	TITANIUM	STAINLESS STEEL	HARD CAST IRON, MEDIUM HARD STEEL	SOFT CAST IRON, MILD STEEL	HARD PLASTICS	ALUMINIUM, BRASS, COPPER, BRONZE ①	COMPOSITE	WOOD, SOFT PLASTICS, CHIPBOARD
	rpm		9-15m/min	10-20m/min	20-35m/min	30-40m/min	50-80m/min	50-100m/min	80-120m/min
Drill Ø mm (in.)									
PISTOL GRIP									
DR350 ø8-10mm (5/16" - 3/8") cap. 	20000							4.0 (5/32")	2.0 (5/64")
	5500						4.0 (5/32")	5.0 (3/16")	6.0 (1/4")
	4500					3.0 (1/8")	6.0 (1/4")		8.0 (5/16")
	3000 ③				4.0 (5/32")	5.0 (3/16")	8.0 (5/16") ②		
	2000		3.0 (1/8")	4.0 (5/32")	6.0 (1/4")	8.0 (5/16")	10.0 (13/32")		
	1000		4.0 (5/32")	6.0 (1/4")	8.0 (5/16")				
	550	6.0 (1/4")	8.0 (5/16")						
DR500 ø8-13mm (5/16" - 1/2") cap. 	18500							4.0 (5/32")	2.0 (5/64")
	5800						4.0 (5/32")	5.0 (3/16")	6.0 (1/4")
	4300					3.0 (1/8")	6.0 (1/4")	10.0 (13/32")	12.0 (1/2")
	2700			3.0 (1/8")	4.0 (5/32")	5.0 (3/16")	8.0 (5/16")	12.0 (1/2")	
	1800		3.0 (1/8")	4.0 (5/32")	6.0 (1/4")	8.0 (5/16")	10.0 (13/32")		
	1400		4.0 (5/32")	5.0 (3/16")	9.0 (11/32")	11.0 (7/16")			
	1000		5.0 (3/16")	6.0 (1/4")	10.0 (13/32")				
600	3.0 (1/8")	7.0 (9/32")	8.0 (5/16")	12.0 (1/3")					
400	6.0 (1/4")	8.0 (5/16")	10.0 (13/32")						
DR750 ø8-13mm (5/16" - 1/2") cap. 	20000						2.0 (5/64")	2.0 (5/64")	
	6000						4.0 (5/32")	5.0 (3/16")	6.0 (1/4")
	4100					3.0 (1/8")	6.0 (1/4")	8.0 (5/16")	10.0 (13/32")
	3300				3.0 (1/8")	4.0 (5/32")	8.0 (5/16")	10.0 (13/32")	12.0* (1/2")
	2700			3.0 (1/8")	4.0 (5/32")	5.0 (3/16")	10.0 (13/32")	13.0* (1/2")	15.0* (19/32")
	1300		4.0 (5/32")	5.0 (3/16")	9.0 (11/32")	11.0* (7/16")	19.0* (3/4")		30.0* (13/16")
	750	3.0 (1/8")	7.0 (9/32")	8.0 (5/16")	15.0* (19/32")	19.0* (3/4")	30.0* (13/16")		
400	6.0 (1/4")	8.0 (5/16")	10.0 (13/32")						
STRAIGHT CASE									
DR300-T... ø8-10mm (5/16" - 3/8") cap. 	20000							4.0 (5/32")	2.0 (5/64")
	5500						4.0 (5/32")	5.0 (3/16")	6.0 (1/4")
	4500					3.0 (1/8")	6.0 (1/4")		8.0 (5/16")
	3000				4.0 (5/32")	5.0 (3/16")	8.0 (5/16")		
	2000		3.0 (1/8")	4.0 (5/32")	6.0 (1/4")	8.0 (5/16")			
	1000	3.0 (1/8")	4.0 (5/32")	6.0 (1/4")	8.0 (5/16")				
550	6.0 (1/4")	8.0 (5/16")							

* above standard chuck capacity

Pistol Grip Drills

0.35 kW (0.5 hp) - 550 to 20000 rpm



A



B



C



D

Accessories: see pages 186-189

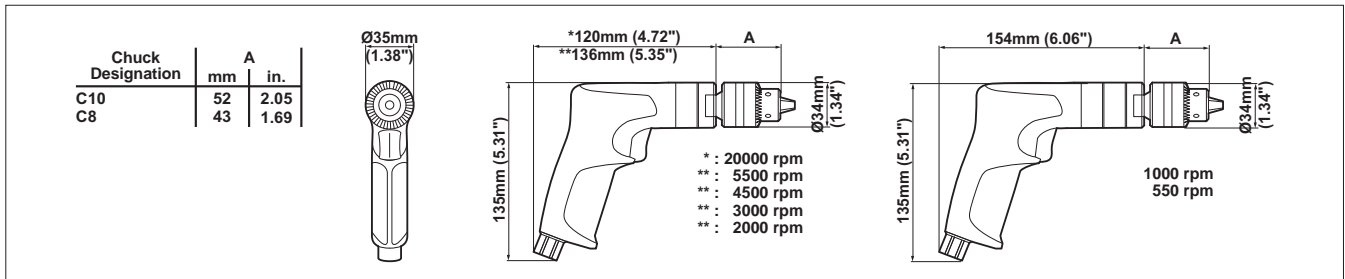

PIC REF	MODEL	PART NUMBER	FREE SPEED	CHUCK SIZE		MOTOR POWER		STALL TORQUE		WEIGHT		AIR FLOW		AIR INLET	HOSE INT. Ø	
			rpm	mm	in.	kW	hp	Nm	In lb	kg	lb	l/s	cfm	in.	mm	in.
TRIGGER START – KEY CHUCK																
A	DR350-P20000-C8	205 147 252 4	20000	8	5/16	0.35	0.5	0.6	5.3	0.62	1.36	9.5	20	1/4	6	1/4
A	DR350-P5500-C8	205 147 250 4	5500	8	5/16	0.35	0.5	2.3	20.4	0.62	1.36	9.5	20	1/4	6	1/4
A	DR350-P4500-C8	205 147 382 4	4500	8	5/16	0.35	0.5	2.7	23.9	0.62	1.36	9.5	20	1/4	6	1/4
A	DR350-P3000-C8	205 147 248 4	3000	8	5/16	0.35	0.5	4.0	35.4	0.62	1.36	9.5	20	1/4	6	1/4
A	DR350-P2000-C8	205 147 246 4	2000	8	5/16	0.35	0.5	5.4	47.8	0.62	1.36	9.5	20	1/4	6	1/4
B	DR350-P1000-C10	205 147 244 4	1000	10	3/8	0.35	0.5	12.7	112.4	0.79	1.74	9.5	20	1/4	6	1/4
B	DR350-P550-C10	205 147 242 4	550	10	3/8	0.35	0.5	18.6	164.6	0.79	1.74	9.5	20	1/4	6	1/4
TRIGGER START – WITHOUT CHUCK																
C	DR350-P20000*	205 147 359 4	20000			0.35	0.5	0.6	5.3	0.49	1.1	9.5	20	1/4	6	1/4
C	DR350-P5500*	205 147 358 4	5500			0.35	0.5	2.3	20.4	0.49	1.1	9.5	20	1/4	6	1/4
C	DR350-P4500*	205 147 384 4	4500			0.35	0.5	2.7	23.9	0.49	1.1	9.5	20	1/4	6	1/4
C	DR350-P3000*	205 147 357 4	3000			0.35	0.5	4.0	35.4	0.49	1.1	9.5	20	1/4	6	1/4
C	DR350-P2000*	205 147 356 4	2000			0.35	0.5	5.4	47.8	0.49	1.1	9.5	20	1/4	6	1/4
D	DR350-P1000*	205 147 355 4	1000			0.35	0.5	12.7	112.4	0.57	1.3	9.5	20	1/4	6	1/4
D	DR350-P550*	205 147 354 4	550			0.35	0.5	18.6	164.6	0.57	1.3	9.5	20	1/4	6	1/4

* Chuck spindle 3/8" x 24 UNF

Pistol Grip Drills

0.5 kW (0.68 hp) - 400 to 18500 rpm



Accessories: see pages 186-189

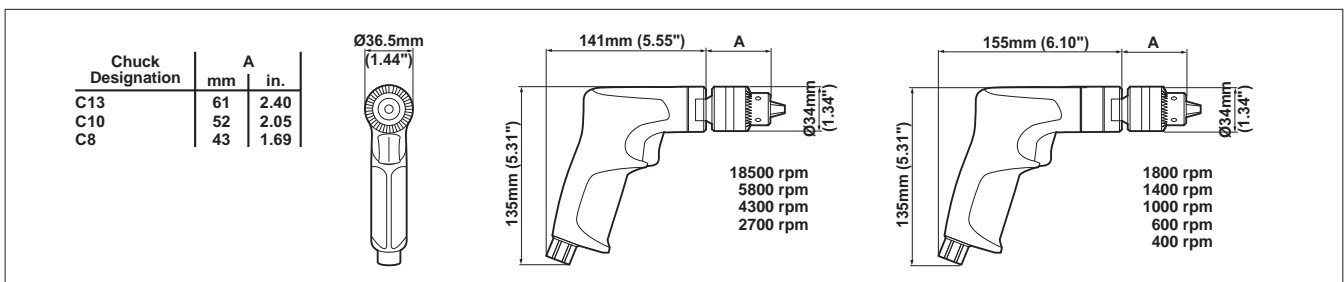

PIC REF	MODEL	PART NUMBER	FREE SPEED	CHUCK SIZE		MOTOR POWER		STALL TORQUE		WEIGHT		AIR FLOW		AIR INLET	HOSE INT. Ø	
				mm	in.	kW	hp	Nm	In lb	kg	lb	l/s	cfm	in.	mm	in.
TRIGGER START – KEY CHUCK																
A	DR500-P18500-C8	205 147 676 4	18500	8	5/16	0.5	0.68	1.0	8.85	0.67	1.5	14	30	1/4	10	3/8
A	DR500-P5800-C8	205 147 673 4	5800	8	5/16	0.5	0.68	3.1	27.44	0.67	1.5	14	30	1/4	10	3/8
A	DR500-P4300-C8	205 147 670 4	4300	8	5/16	0.5	0.68	4.2	37.17	0.67	1.5	14	30	1/4	10	3/8
A	DR500-P2700-C8	205 147 667 4	2700	8	5/16	0.5	0.68	6.9	61.07	0.67	1.5	14	30	1/4	10	3/8
B	DR500-P1800-C10	205 147 664 4	1800	10	3/8	0.5	0.68	9.9	87.62	0.84	1.8	14	30	1/4	10	3/8
B	DR500-P1400-C10	205 147 661 4	1400	10	3/8	0.5	0.68	13.4	118.59	0.84	1.8	14	30	1/4	10	3/8
B	DR500-P1000-C10	205 147 658 4	1000	10	3/8	0.5	0.68	18.0	159.3	0.84	1.8	14	30	1/4	10	3/8
B	DR500-P600-C13	205 147 655 4	600	13	1/2	0.5	0.68	28.7	254	0.96	2.1	14	30	1/4	10	3/8
B	DR500-P400-C13	205 147 652 4	400	13	1/2	0.5	0.68	46.0	407.1	0.96	2.1	14	30	1/4	10	3/8
TRIGGER START – WITHOUT CHUCK																
C	DR500-P18500*	205 147 678 4	18500			0.5	0.68	1.0	8.85	0.56	1.2	14	30	1/4	10	3/8
C	DR500-P5800*	205 147 675 4	5800			0.5	0.68	3.1	27.44	0.56	1.2	14	30	1/4	10	3/8
C	DR500-P4300*	205 147 672 4	4300			0.5	0.68	4.2	37.17	0.56	1.2	14	30	1/4	10	3/8
C	DR500-P2700*	205 147 669 4	2700			0.5	0.68	6.9	61.07	0.56	1.2	14	30	1/4	10	3/8
D	DR500-P1800*	205 147 666 4	1800			0.5	0.68	9.9	87.62	0.64	1.4	14	30	1/4	10	3/8
D	DR500-P1400*	205 147 663 4	1400			0.5	0.68	13.4	118.59	0.64	1.4	14	30	1/4	10	3/8
D	DR500-P1000*	205 147 660 4	1000			0.5	0.68	18.0	159.3	0.64	1.4	14	30	1/4	10	3/8
D	DR500-P600*	205 147 657 4	600			0.5	0.68	28.7	254	0.64	1.4	14	30	1/4	10	3/8
D	DR500-P400*	205 147 654 4	400			0.5	0.68	46.0	407.1	0.64	1.4	14	30	1/4	10	3/8

* Chuck spindle 3/8" x 24 UNF

Pistol Grip Drills

High Power Drill

0.75 kW (1 hp) - 400 to 20000 rpm



Accessories: see pages 186-189

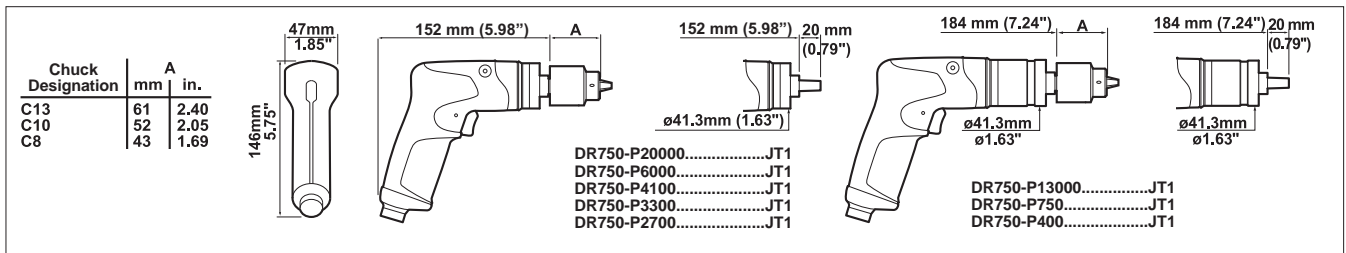

PIC REF	MODEL	PART NUMBER	FREE SPEED		CHUCK SIZE		MOTOR POWER		STALL TORQUE		WEIGHT		AIR FLOW		AIR INLET		HOSE INT. Ø	
			rpm		mm	in.	kW	hp	Nm	In lb	kg	lb	l/s	cfm	in.	mm	in.	

TRIGGER START - KEY CHUCK

A	DR750-P20000-C8	205 146 659 4	20000		8	5/16	0.75	1.00	1.6	14.2	1.1	2.4	14	30	1/4	10	3/8
A	DR750-P6000-C8	1465124	6000		8	5/16	0.75	1.00	5.3	46.9	1.1	2.4	14	30	1/4	10	3/8
A	DR750-P4100-C8	1465114	4100		8	5/16	0.75	1.00	7.1	62.8	1.1	2.4	14	30	1/4	10	3/8
A	DR750-P3300-C10	1465104	3300		10	3/8	0.75	1.00	9.6	85.0	1.1	2.4	14	30	1/4	10	3/8
A	DR750-P2700-C10	1465094	2700		10	3/8	0.75	1.00	11.1	98.2	1.1	2.4	14	30	1/4	10	3/8
B	DR750-P1300-C10	1465084	1300		10	3/8	0.75	1.00	23.9	211.5	1.6	3.5	14	30	1/4	10	3/8
B	DR750-P750-C13	1465074	750		13	1/2	0.75	1.00	41.0	362.9	1.6	3.5	14	30	1/4	10	3/8
B	DR750-P400-C13	205 146 658 4	400		13	1/2	0.75	1.00	55.0	486.8	1.6	3.5	14	30	1/4	10	3/8

TRIGGER START - JACOBS TAPER 1 SPINDLE - WITHOUT CHUCK

C	DR750-P20000-JT1	205 146 667 4	20000				0.75	1.00	1.6	14.2	0.9	2.0	14	30	1/4	10	3/8
C	DR750-P6000-JT1	205 146 666 4	6000				0.75	1.00	5.3	46.9	0.9	2.0	14	30	1/4	10	3/8
C	DR750-P4100-JT1	205 146 665 4	4100				0.75	1.00	7.1	62.8	0.9	2.0	14	30	1/4	10	3/8
C	DR750-P3300-JT1	205 146 664 4	3300				0.75	1.00	9.6	85.0	0.9	2.0	14	30	1/4	10	3/8
C	DR750-P2700-JT1	205 146 663 4	2700				0.75	1.00	11.1	98.2	0.9	2.0	14	30	1/4	10	3/8
D	DR750-P1300-JT1	205 146 662 4	1300				0.75	1.00	23.9	211.5	1.15	2.5	14	30	1/4	10	3/8
D	DR750-P750-JT1	205 146 661 4	750				0.75	1.00	41.0	362.9	1.15	2.5	14	30	1/4	10	3/8
D	DR750-P400-JT1	205 146 660 4	400				0.75	1.00	55.0	486.8	1.15	2.5	14	30	1/4	10	3/8

TRIGGER START - WITHOUT CHUCK

E	DR750-P20000*	205 147 458 4	20000				0.75	1.00	1.6	14.2	0.9	2.0	14	30	1/4	10	3/8
E	DR750-P6000*	205 147 417 4	6000				0.75	1.00	5.3	46.9	0.9	2.0	14	30	1/4	10	3/8
E	DR750-P4100*	205 147 456 4	4100				0.75	1.00	7.1	62.8	0.9	2.0	14	30	1/4	10	3/8
E	DR750-P3300*	205 147 455 4	3300				0.75	1.00	9.6	85.0	0.9	2.0	14	30	1/4	10	3/8
E	DR750-P2700*	205 147 416 4	2700				0.75	1.00	11.1	98.2	0.9	2.0	14	30	1/4	10	3/8
F	DR750-P1300*	205 147 415 4	1300				0.75	1.00	23.9	211.5	1.15	2.5	14	30	1/4	10	3/8
F	DR750-P750**	205 147 452 4	750				0.75	1.00	41.0	362.9	1.15	2.5	14	30	1/4	10	3/8
F	DR750-P400**	205 147 451 4	400				0.75	1.00	55.0	486.8	1.15	2.5	14	30	1/4	10	3/8

* Chuck spindle 3/8" x 24 UNF
 ** Chuck spindle 1/2" x 20 UNF

Straight Grip Drills

0.3 kW (0.4 hp) - 550 to 20000 rpm



A



B



C



D



E



F

Accessories: see pages 186-189

Model	L		L1		Ø	
	mm	in.	mm	in.	mm	in.
DR300-T20000-C8	197	7.76	145	5.71	30	1.18
DR300-T5500-C8	214	8.43	159	6.26	30	1.18
DR300-T4500-C8	214	8.43	159	6.26	30	1.18
DR300-T3000-C8	214	8.43	159	6.26	30	1.18
DR300-T2000-C8	214	8.43	159	6.26	30	1.18
DR300-T1000-C10	231	9.09	176	6.93	36	1.42
DR300-T550-C10	231	9.09	176	6.93	36	1.42

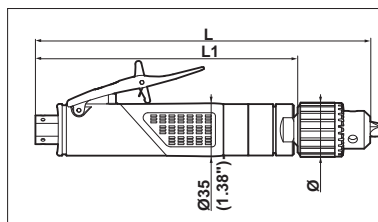

PIC REF	MODEL	PART NUMBER	FREE SPEED	CHUCK SIZE		MOTOR POWER		STALL TORQUE		WEIGHT		AIR FLOW		AIR INLET		HOSE INT. Ø	
				rpm	mm	in.	kW	hp	Nm	in lb	kg	lb	l/s	cfm	in.	mm	in.

KEY CHUCK

A	DR300-T20000-C8	205 147 496 4	20000	8	5/16	0.3	0.4	0.6	5.3	0.47	1.03	9.5	20	1/4	6	1/4
B	DR300-T5500-C8	205 147 493 4	5500	8	5/16	0.3	0.4	2.3	20.4	0.6	1.32	9.5	20	1/4	6	1/4
B	DR300-T4500-C8	205 147 490 4	4500	8	5/16	0.3	0.4	2.7	23.9	0.6	1.32	9.5	20	1/4	6	1/4
B	DR300-T3000-C8	205 147 487 4	3000	8	5/16	0.3	0.4	4.0	35.4	0.6	1.32	9.5	20	1/4	6	1/4
B	DR300-T2000-C8	205 147 484 4	2000	8	5/16	0.3	0.4	5.4	47.8	0.6	1.32	9.5	20	1/4	6	1/4
C	DR300-T1000-C10	205 147 481 4	1000	10	3/8	0.3	0.4	12.7	112.4	0.75	1.65	9.5	20	1/4	6	1/4
C	DR300-T550-C10	205 147 478 4	550	10	3/8	0.3	0.4	18.6	164.6	0.75	1.65	9.5	20	1/4	6	1/4

WITHOUT CHUCK

D	DR300-T20000*	205 147 495 4	20000			0.3	0.4	0.6	5.3	0.34	0.75	9.5	20	1/4	6	1/4
E	DR300-T5500*	205 147 492 4	5500			0.3	0.4	2.3	20.4	0.47	1.04	9.5	20	1/4	6	1/4
E	DR300-T4500*	205 147 489 4	4500			0.3	0.4	2.7	23.9	0.47	1.04	9.5	20	1/4	6	1/4
E	DR300-T3000*	205 147 486 4	3000			0.3	0.4	4.0	35.4	0.47	1.04	9.5	20	1/4	6	1/4
E	DR300-T2000*	205 147 483 4	2000			0.3	0.4	5.4	47.8	0.47	1.04	9.5	20	1/4	6	1/4
F	DR300-T1000*	205 147 480 4	1000			0.3	0.4	12.7	112.4	0.52	1.15	9.5	20	1/4	6	1/4
F	DR300-T550*	205 147 477 4	550			0.3	0.4	18.6	164.6	0.52	1.15	9.5	20	1/4	6	1/4

* Chuck spindle 3/8" x 24 UNF

Angle Drill Selection

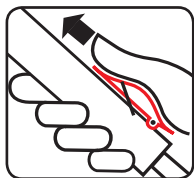

Ergonomics

Spindle and lock ring

By locking the spindle the drill bit can be replaced using a single tool.

DRILL SELECTION GUIDE – ANGLE DRILL

How to select your tool:
 ① Select material ② Select hole size ③ Define speed

TOOL TYPE	FREE SPEED	TITANIUM	STAINLESS STEEL	HARD CAST IRON, MEDIUM HARD STEEL	SOFT CAST IRON, MILD STEEL ①	HARD PLASTICS	ALUMINIUM, BRASS, COPPER, BRONZE	COMPOSITE	WOOD, SOFT PLASTICS, CHIPBOARD
	rpm		9-15m/min	10-20m/min	20-35m/min	30-40m/min	50-80m/min	50-100m/min	80-120m/min
					Drill ø mm				

COMPACT HEAD

DR300-T5/S5 (30°, 45°, 90° & 360° head)	5500	-	-	-	-	3.0 (1/8")	5.0 (3/16")	5.0 (3/16")	5.0 (3/16")
	4500	-	-	-	-	3.0 (1/8")	5.0 (3/16")	5.0 (3/16")	5.0 (3/16")
DR300-QR (30°, 45°, 90° & 360° head)	3000 ③	-	-	-	3.0 (1/8") ②	5.0 (3/16")	5.0 (3/16")	5.0 (3/16")	-
	2000	-	3.0 (1/8")	4.0 (5/32")	5.0 (3/16")	-	-	-	-
	1000	-	4.0 (5/32")	5.0 (3/16")	-	-	-	-	-

STANDARD HEAD

DR300-T6/S6 (90° & 360° head)	5500	-	-	-	-	3.0 (1/8")	6.0 (1/4")	5.0 (3/16")	6.5 (1/4")
	4500	-	-	-	-	3.0 (1/8")	6.0 (1/4")	5.0 (3/16")	6.5 (1/4")
	3000	-	-	-	3.0 (1/8")	5.0 (3/16")	6.5 (1/4")	6.5 (1/4")	-
DR300-QR (90° & 360° head)	2000	-	3.0 (1/8")	4.0 (5/32")	6.5 (1/4")	6.5 (1/4")	-	6.5 (1/4")	-
	1000	-	4.0 (5/32")	6.0 (1/4")	6.5 (1/4")	-	-	-	-
	550	6.0 (1/4")	6.5 (1/4")	6.5 (1/4")	-	-	-	-	-

HEAVY DUTY

D3141 (90° head)	2100	-	3.0 (1/8")	3.0 (1/8")	6.0 (1/4")	8.0 (5/16")	8.0 (5/16")	8.0 (5/16")	8.0 (5/16")
D3143 (90° head)	770	-	7.0 (9/32")	8.0 (5/16")	8.0 (5/16")	-	-	-	-
	2100	-	3.0 (1/8")	3.0 (1/8")	6.0 (1/4")	6.5 (1/4")	6.5 (1/4")	6.5 (1/4")	6.5 (1/4")
	770	-	6.5 (1/4")	6.5 (1/4")	6.5 (1/4")	-	-	-	-

Angle Drills

Compact 90° Angle Head
0.3 kW (0.4 hp) - 1000 to 5500 rpm



A



B



C



D

Accessories: see page 187 

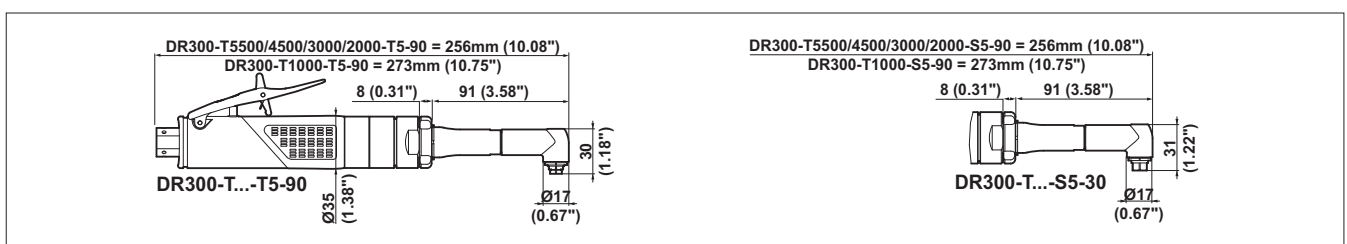

PIC REF	MODEL	PART NUMBER	FREE SPEED	MOTOR POWER		WEIGHT		AIR FLOW		AIR INLET	HOSE INT. Ø	
			rpm	kW	hp	kg	lb	l/s	cfm	in.	mm	in.

COLLET SPINDLE - Max. capacity: 5mm (3/16")

A	DR300-T5500-T5-90	205 147 551 4	5500	0.3	0.4	0.62	1.36	9.5	20	1/4	6	1/4
A	DR300-T4500-T5-90	205 147 549 4	4500	0.3	0.4	0.62	1.36	9.5	20	1/4	6	1/4
A	DR300-T3000-T5-90	205 147 547 4	3000	0.3	0.4	0.62	1.36	9.5	20	1/4	6	1/4
A	DR300-T2000-T5-90	205 147 545 4	2000	0.3	0.4	0.62	1.36	9.5	20	1/4	6	1/4
B	DR300-T1000-T5-90	205 147 543 4	1000	0.3	0.4	0.70	1.54	9.5	20	1/4	6	1/4

1/4" x 28 SPINDLE - Max. capacity: 5mm (3/16")

C	DR300-T5500-S5-90	205 147 552 4	5500	0.3	0.4	0.62	1.36	9.5	20	1/4	6	1/4
C	DR300-T4500-S5-90	205 147 550 4	4500	0.3	0.4	0.62	1.36	9.5	20	1/4	6	1/4
C	DR300-T3000-S5-90	205 147 548 4	3000	0.3	0.4	0.62	1.36	9.5	20	1/4	6	1/4
C	DR300-T2000-S5-90	205 147 546 4	2000	0.3	0.4	0.62	1.36	9.5	20	1/4	6	1/4
D	DR300-T1000-S5-90	205 147 544 4	1000	0.3	0.4	0.70	1.54	9.5	20	1/4	6	1/4

Angle Drills

Standard 90° Angle Head

0.3 kW (0.4 hp) - 550 to 5500 rpm



A



B



C



D

Accessories: see page 187 

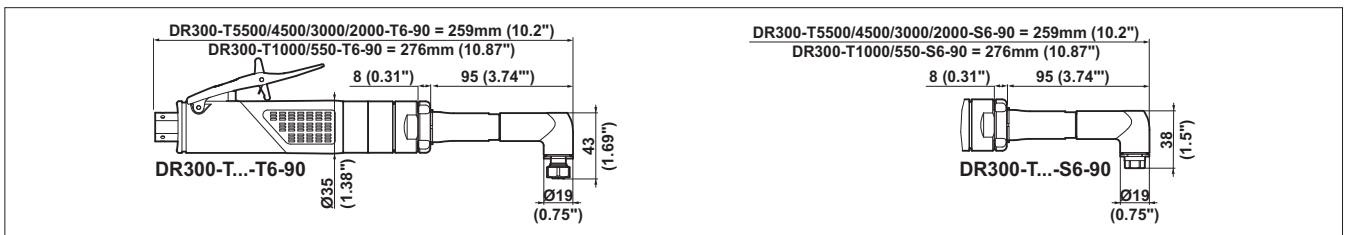

PIC REF	MODEL	PART NUMBER	FREE SPEED		MOTOR POWER		WEIGHT		AIR FLOW		AIR INLET		HOSE INT. Ø	
			rpm		kW	hp	kg	lb	l/s	cfm	in.	mm	in.	

COLLET SPINDLE - Max. capacity: 6.4mm (1/4")

A	DR300-T5500-T6-90	205 147 598 4	5500		0.3	0.4	0.68	1.50	9.5	20	1/4	6	1/4
A	DR300-T4500-T6-90	205 147 595 4	4500		0.3	0.4	0.68	1.50	9.5	20	1/4	6	1/4
A	DR300-T3000-T6-90	205 147 592 4	3000		0.3	0.4	0.68	1.50	9.5	20	1/4	6	1/4
A	DR300-T2000-T6-90	205 147 589 4	2000		0.3	0.4	0.68	1.50	9.5	20	1/4	6	1/4
B	DR300-T1000-T6-90	205 147 586 4	1000		0.3	0.4	0.76	1.67	9.5	20	1/4	6	1/4
B	DR300-T550-T6-90	205 147 583 4	550		0.3	0.4	0.76	1.67	9.5	20	1/4	6	1/4

1/4" x 28 SPINDLE - Max. capacity: 6.4mm (1/4")

C	DR300-T5500-S6-90	205 147 599 4	5500		0.3	0.4	0.68	1.50	9.5	20	1/4	6	1/4
C	DR300-T4500-S6-90	205 147 596 4	4500		0.3	0.4	0.68	1.50	9.5	20	1/4	6	1/4
C	DR300-T3000-S6-90	205 147 593 4	3000		0.3	0.4	0.68	1.50	9.5	20	1/4	6	1/4
C	DR300-T2000-S6-90	205 147 590 4	2000		0.3	0.4	0.68	1.50	9.5	20	1/4	6	1/4
D	DR300-T1000-S6-90	205 147 587 4	1000		0.3	0.4	0.76	1.67	9.5	20	1/4	6	1/4
D	DR300-T550-S6-90	205 147 584 4	550		0.3	0.4	0.76	1.67	9.5	20	1/4	6	1/4

Angle Drills

Heavy Duty 90° Angle Head
0.28 kW (0.38 hp) - 770 and 2100 rpm

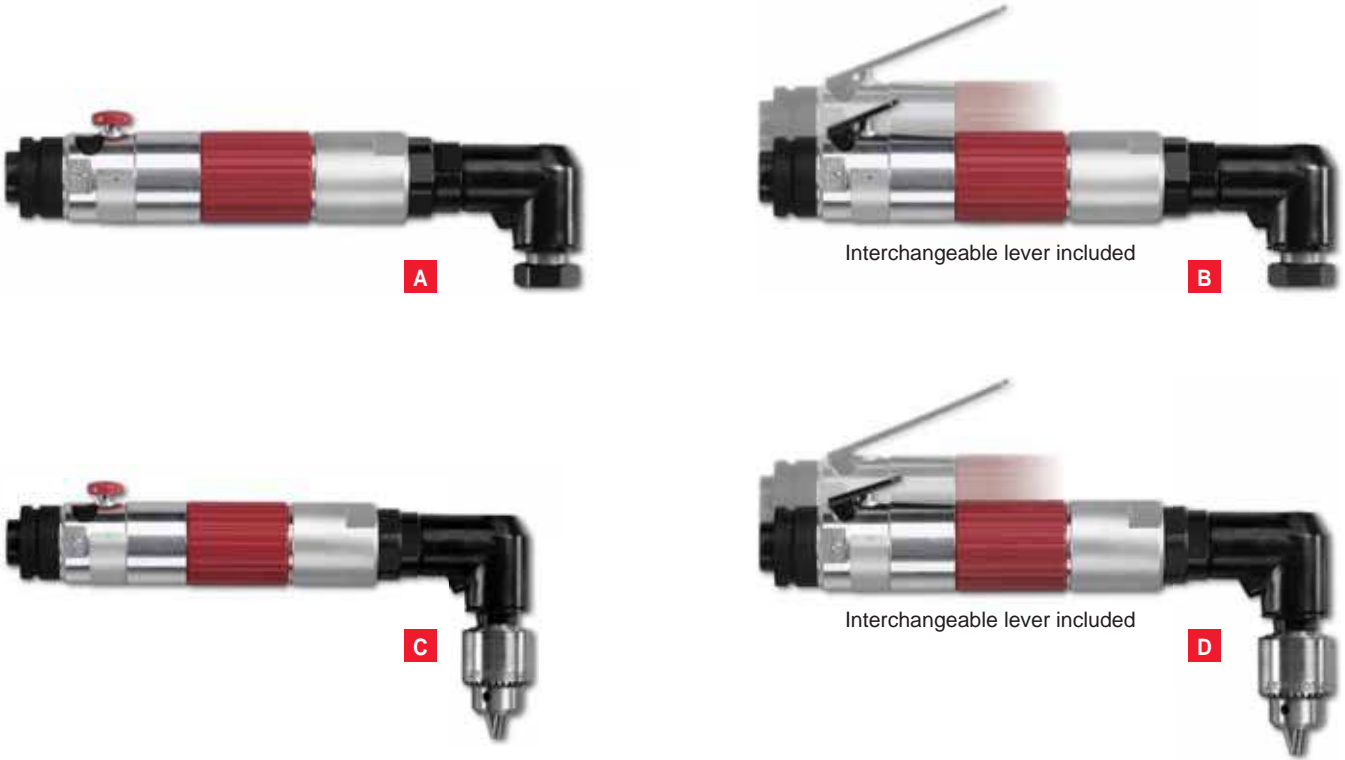

Accessories: see page 187 

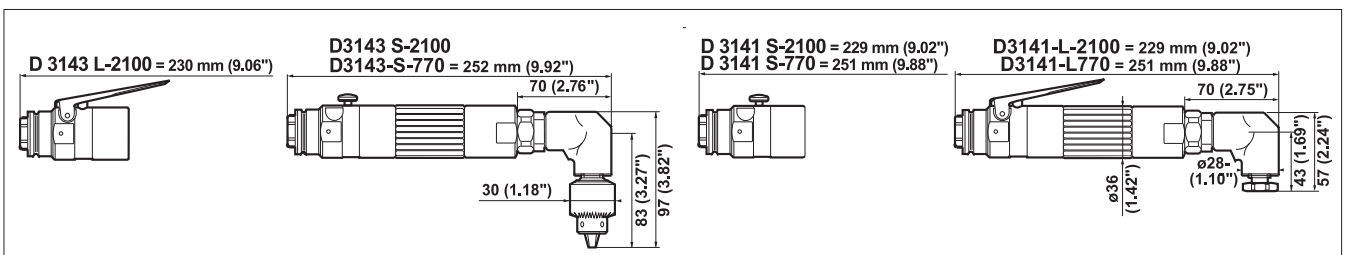

PIC REF	MODEL	PART NUMBER	FREE SPEED		MOTOR POWER		WEIGHT		AIR FLOW		AIR INLET		HOSE INT. Ø	
			rpm		kW	hp	kg	lb	l/s	cfm	in.	mm	in.	

COLLET SPINDLE – Max. capacity: 8mm (5/16")

Button Start

A	D3141-S-2100	1383084	2100	0.28	0.38	0.86	1.9	9.4	19.9	1/4	6	1/4
A	D3141-S-770	1383244	770	0.28	0.38	1.00	2.2	9.4	19.9	1/4	6	1/4

Lever Start

B	D3141-L-2100	1383164	2100	0.28	0.38	0.86	1.9	9.4	19.9	1/4	6	1/4
B	D3141-L-770	1383324	770	0.28	0.38	1.00	2.2	9.4	19.9	1/4	6	1/4

KEY CHUCK – Capacity: 8mm (5/16")

Button Start

C	D3143-S-2100	1383404	2100	0.28	0.38	0.96	2.1	9.4	19.9	1/4	6	1/4
C	D3143-S-770	1383664	770	0.28	0.38	1.00	2.2	9.4	19.9	1/4	6	1/4

Lever Start

D	D3143-L-2100	1383584	2100	0.28	0.38	0.96	2.1	9.4	19.9	1/4	6	1/4
---	--------------	---------	------	------	------	------	-----	-----	------	-----	---	-----

Angle Drills

Compact 30° and 45° Angle Head
0.3 kW (0.4 hp) - 550 to 5500 rpm



Accessories: see page 187

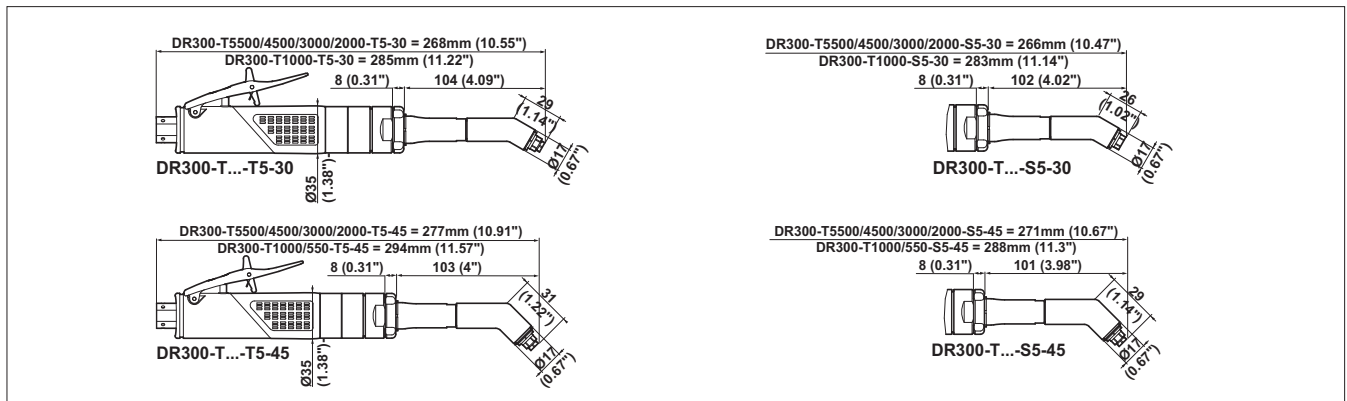

PIC REF	MODEL	PART NUMBER	FREE SPEED	MOTOR POWER	WEIGHT		AIR FLOW		AIR INLET	HOSE INT. Ø	
			rpm	kW	hp	kg	lb	l/s	cfm	in.	mm

COLLET SPINDLE - Max. capacity: 5mm (3/16")

A	DR300-T5500-T5-30	205 147 539 4	5500	0.3	0.4	0.62	1.36	9.5	20	1/4	6	1/4
A	DR300-T4500-T5-30	205 147 537 4	4500	0.3	0.4	0.62	1.36	9.5	20	1/4	6	1/4
A	DR300-T3000-T5-30	205 147 535 4	3000	0.3	0.4	0.62	1.36	9.5	20	1/4	6	1/4
A	DR300-T2000-T5-30	205 147 533 4	2000	0.3	0.4	0.62	1.36	9.5	20	1/4	6	1/4
B	DR300-T1000-T5-30	205 147 531 4	1000	0.3	0.4	0.70	1.54	9.5	20	1/4	6	1/4

1/4" x 28 SPINDLE - Max. capacity: 5mm (3/16")

A	DR300-T5500-S5-30	205 147 540 4	5500	0.3	0.4	0.62	1.36	9.5	20	1/4	6	1/4
A	DR300-T4500-S5-30	205 147 538 4	4500	0.3	0.4	0.62	1.36	9.5	20	1/4	6	1/4
A	DR300-T3000-S5-30	205 147 536 4	3000	0.3	0.4	0.62	1.36	9.5	20	1/4	6	1/4
A	DR300-T2000-S5-30	205 147 534 4	2000	0.3	0.4	0.62	1.36	9.5	20	1/4	6	1/4
B	DR300-T1000-S5-30	205 147 532 4	1000	0.3	0.4	0.70	1.54	9.5	20	1/4	6	1/4

COLLET SPINDLE - Max. capacity: 5mm (3/16")

C	DR300-T5500-T5-45	205 147 580 4	5500	0.3	0.4	0.68	1.36	9.5	20	1/4	6	1/4
C	DR300-T4500-T5-45	205 147 577 4	4500	0.3	0.4	0.68	1.36	9.5	20	1/4	6	1/4
C	DR300-T3000-T5-45	205 147 574 4	3000	0.3	0.4	0.68	1.49	9.5	20	1/4	6	1/4
C	DR300-T2000-T5-45	205 147 571 4	2000	0.3	0.4	0.68	1.49	9.5	20	1/4	6	1/4
D	DR300-T1000-T5-45	205 147 568 4	1000	0.3	0.4	0.76	1.67	9.5	20	1/4	6	1/4
D	DR300-T550-T5-45	205 147 565 4	550	0.3	0.4	0.76	1.67	9.5	20	1/4	6	1/4

1/4" x 28 SPINDLE - Max. capacity: 5mm (3/16")

C	DR300-T5500-S5-45	205 147 581 4	5500	0.3	0.4	0.68	1.36	9.5	20	1/4	6	1/4
C	DR300-T4500-S5-45	205 147 578 4	4500	0.3	0.4	0.68	1.36	9.5	20	1/4	6	1/4
C	DR300-T3000-S5-45	205 147 575 4	3000	0.3	0.4	0.68	1.49	9.5	20	1/4	6	1/4
C	DR300-T2000-S5-45	205 147 572 4	2000	0.3	0.4	0.68	1.49	9.5	20	1/4	6	1/4
D	DR300-T1000-S5-45	205 147 569 4	1000	0.3	0.4	0.76	1.67	9.5	20	1/4	6	1/4
D	DR300-T550-S5-45	205 147 566 4	550	0.3	0.4	0.76	1.67	9.5	20	1/4	6	1/4

Angle Drills

Compact and Standard 360° Angle Head
0.3 kW (0.4 hp) - 550 to 5500 rpm



Accessories: see page 187

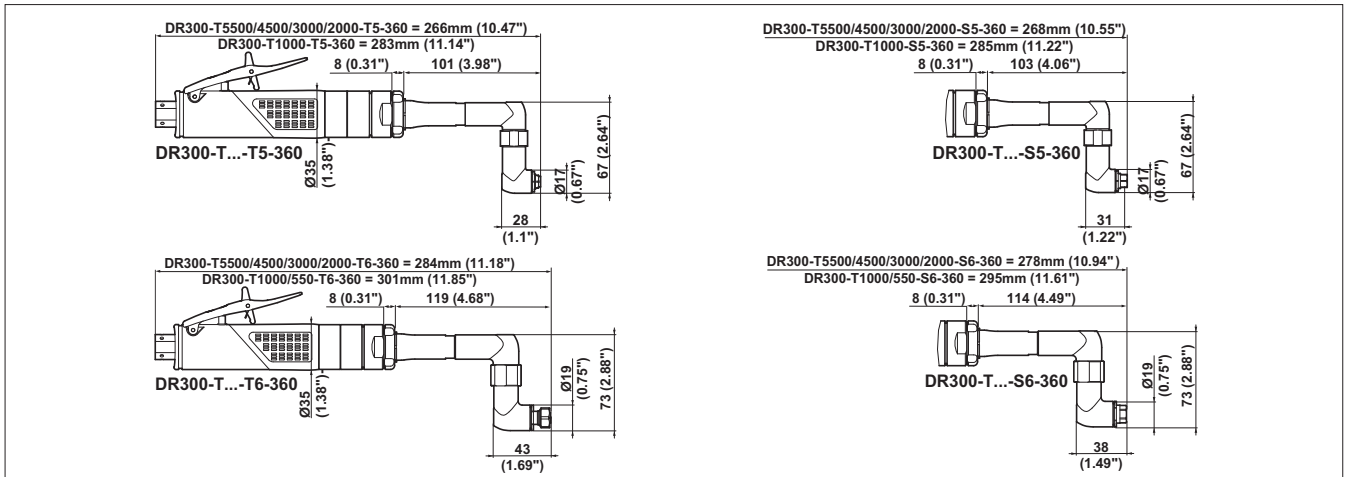

PIC REF	MODEL	PART NUMBER	FREE SPEED		MOTOR POWER		WEIGHT		AIR FLOW		AIR INLET		HOSE INT. Ø	
			rpm		kW	hp	kg	lb	l/s	cfm	in.	mm	in.	

COLLET SPINDLE - Max. capacity: 5mm (3/16")

A	DR300-T5500-T5-360	205 147 563 4	5500	0.3	0.4	0.70	1.54	9.5	20	1/4	6	1/4
A	DR300-T4500-T5-360	205 147 561 4	4500	0.3	0.4	0.70	1.54	9.5	20	1/4	6	1/4
A	DR300-T3000-T5-360	205 147 559 4	3000	0.3	0.4	0.70	1.54	9.5	20	1/4	6	1/4
A	DR300-T2000-T5-360	205 147 557 4	2000	0.3	0.4	0.70	1.54	9.5	20	1/4	6	1/4
B	DR300-T1000-T5-360	205 147 555 4	1000	0.3	0.4	0.78	1.72	9.5	20	1/4	6	1/4

1/4" x 28 SPINDLE - Max. capacity: 5mm (3/16")

A	DR300-T5500-S5-360	205 147 564 4	5500	0.3	0.4	0.70	1.54	9.5	20	1/4	6	1/4
A	DR300-T4500-S5-360	205 147 562 4	4500	0.3	0.4	0.70	1.54	9.5	20	1/4	6	1/4
A	DR300-T3000-S5-360	205 147 560 4	3000	0.3	0.4	0.70	1.54	9.5	20	1/4	6	1/4
A	DR300-T2000-S5-360	205 147 558 4	2000	0.3	0.4	0.70	1.54	9.5	20	1/4	6	1/4
B	DR300-T1000-S5-360	205 147 556 4	1000	0.3	0.4	0.78	1.72	9.5	20	1/4	6	1/4

COLLET SPINDLE - Max. capacity: 6.4mm (1/4")

C	DR300-T5500-T6-360	205 147 616 4	5500	0.3	0.4	0.77	1.69	9.5	20	1/4	6	1/4
C	DR300-T4500-T6-360	205 147 613 4	4500	0.3	0.4	0.77	1.69	9.5	20	1/4	6	1/4
C	DR300-T3000-T6-360	205 147 610 4	3000	0.3	0.4	0.77	1.69	9.5	20	1/4	6	1/4
C	DR300-T2000-T6-360	205 147 607 4	2000	0.3	0.4	0.77	1.69	9.5	20	1/4	6	1/4
D	DR300-T1000-T6-360	205 147 604 4	1000	0.3	0.4	0.85	1.87	9.5	20	1/4	6	1/4
D	DR300-T550-T6-360	205 147 601 4	550	0.3	0.4	0.85	1.87	9.5	20	1/4	6	1/4

1/4" x 28 SPINDLE - Max. capacity: 6.4mm (1/4")

C	DR300-T5500-S6-360	205 147 617 4	5500	0.3	0.4	0.77	1.69	9.5	20	1/4	6	1/4
C	DR300-T4500-S6-360	205 147 614 4	4500	0.3	0.4	0.77	1.69	9.5	20	1/4	6	1/4
C	DR300-T3000-S6-360	205 147 611 4	3000	0.3	0.4	0.77	1.69	9.5	20	1/4	6	1/4
C	DR300-T2000-S6-360	205 147 608 4	2000	0.3	0.4	0.77	1.69	9.5	20	1/4	6	1/4
D	DR300-T1000-S6-360	205 147 605 4	1000	0.3	0.4	0.85	1.87	9.5	20	1/4	6	1/4
D	DR300-T550-S6-360	205 147 602 4	550	0.3	0.4	0.85	1.87	9.5	20	1/4	6	1/4

Accessories

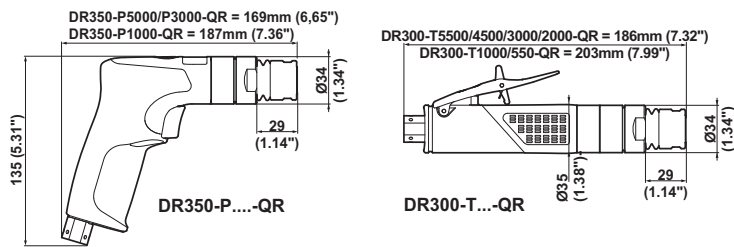

DR350-P...-QR / DR300-T...-QR

ACCESSORIES INCLUDED

ITEM	205 050 331 3 205 050 329 3 205 050 333 3 205 050 335 3	ANGLE HEAD 205 050 338 3 205 050 341 3	205 050 353 3	DRILLS DR300
• ø 4.8mm (3/16\") capacity collet	2552			
• ø 6.4mm (1/4\") capacity collet		19182		
• ø 8mm (5/16\") capacity collet			615 526 088 0	
1 Safety lever				205 050 288 3
2 Side handle (for DR300-T550/1000/2000/3000)				205 049 446 3
• Exhaust hose (with clamping)				205 050 746 3
• Wrench 8 & 9.5 mm (Qty 2)	268263			
• Wrench 10mm		82623		



OPTIONAL ACCESSORIES

ITEM	PART NO.
3 Short lever	205 050 299 3
4 Inlet button (with lever recess plugs)	205 050 045 3
2 Side handle	205 049 446 3
5 Keyed chuck C6 - 3/8\" UNF - cap, 0.5 to 6.5 (with key)	205 055 272 3
5 Keyed chuck C8 - 3/8\" UNF - cap, 0.5 to 8 (with key)	205 053 013 3
• Vacuum kit for 90° angle head drill - DR300	See page 182

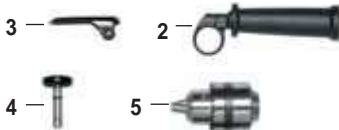

Collet for Angle Heads: D, E, F & G



COLLET CAPACITY	PART NUMBER	COLLET CAPACITY	PART NUMBER	COLLET CAPACITY	PART NUMBER	COLLET CAPACITY	PART NUMBER	COLLET CAPACITY	PART NUMBER
ø 0.8mm	2152	ø 1.8mm	2252	ø 2.8mm	2352	ø 3.8mm	2452	ø 4.8mm	2552
ø 0.9mm	2162	ø 1.9mm	2262	ø 2.9mm	2362	ø 3.9mm	2462	ø 4.9mm	2562
ø 1.0mm	2172	ø 2.0mm	2272	ø 3.0mm	2372	ø 4.0mm	2472	ø 5.0mm	2572
ø 1.1mm	2182	ø 2.1mm	2282	ø 3.1mm	2382	ø 4.1mm	2482		
ø 1.2mm	2192	ø 2.2mm	2292	ø 3.2mm	2392	ø 4.2mm	2492	ø 1/16"	91442
ø 1.3mm	2202	ø 2.3mm	2302	ø 3.3mm	2402	ø 4.3mm	2502	ø 3/32"	91452
ø 1.4mm	2212	ø 2.4mm	2312	ø 3.4mm	2412	ø 4.4mm	2512	ø 1/8"	91462
ø 1.5mm	2222	ø 2.5mm	2322	ø 3.5mm	2422	ø 4.5mm	2522	ø 5/32"	91472
ø 1.6mm	2232	ø 2.6mm	2332	ø 3.6mm	2432	ø 4.6mm	2532	ø 11/64"	108172
ø 1.7mm	2242	ø 2.7mm	2342	ø 3.7mm	2442	ø 4.7mm	2542	ø 3/16"	91482

Collet for Angle Heads: H & J



COLLET CAPACITY	PART NUMBER	COLLET CAPACITY	PART NUMBER	COLLET CAPACITY	PART NUMBER	COLLET CAPACITY	PART NUMBER	COLLET CAPACITY	PART NUMBER
ø 1.6mm	18922	ø 2.8mm	18982	ø 3.8mm	19042	ø 4.8mm	19092	ø 5.8mm	19152
ø 1.8mm	18932	ø 3.0mm	18992	ø 4.0mm	19052	ø 5.0mm	19102	ø 6.0mm	19162
ø 2.0mm	18942	ø 3.2mm	19002	ø 4.2mm	19062	ø 5.2mm	19122	ø 6.2mm	19172
ø 2.2mm	18952	ø 3.4mm	19022	ø 4.4mm	19072	ø 5.4mm	19132	ø 6.4mm	19182
ø 2.6mm	18972	ø 3.6mm	19032	ø 4.6mm	19082	ø 5.6mm	19142		

Collet for Angle Head: P.N. 205 050 353 3



COLLET CAPACITY	PART NUMBER	COLLET CAPACITY	PART NUMBER	COLLET CAPACITY	PART NUMBER	COLLET CAPACITY	PART NUMBER
ø 2.0mm	615 526 066 0	ø 3.5mm	615 526 070 0	ø 5.0mm	615 526 075 0	ø 7.0mm	615 526 083 0
ø 2.5mm	615 526 068 0	ø 4.0mm	615 526 071 0	ø 5.5mm	615 526 077 0	ø 7.5mm	615 526 084 0
ø 3.0mm	615 526 069 0	ø 4.5mm	615 526 073 0	ø 6.0mm	615 526 079 0	ø 8.0mm	615 526 088 0

Multi Drills

0.3 and 0.35 kW (0.4 - 0.5 hp) - 550 to 5500 rpm

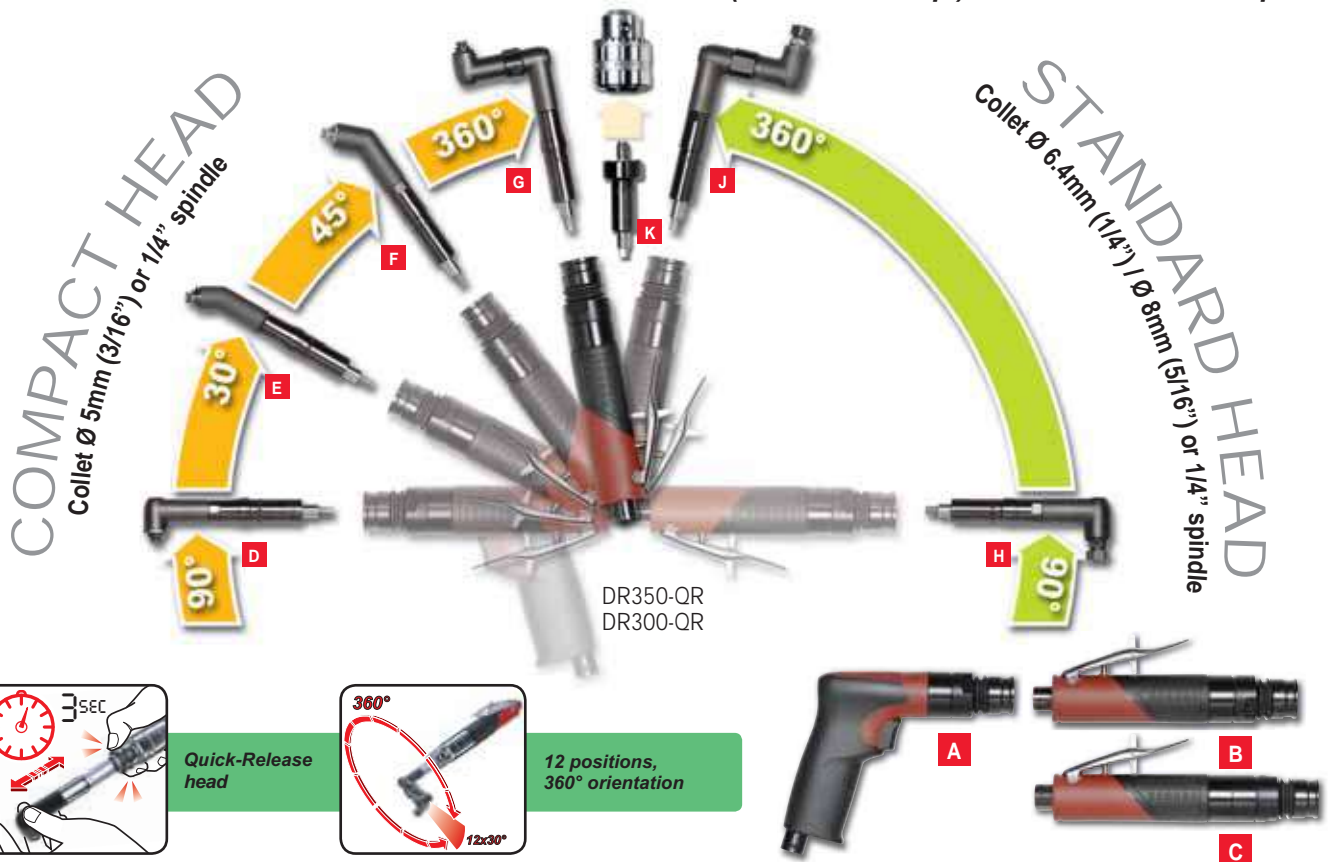

PIC REF	MODEL	PART NUMBER	FREE SPEED		MOTOR POWER		WEIGHT		LENGTH		AIR FLOW		AIR INLET		HOSE INT. Ø	
			rpm		kW	hp	kg	lb	mm	in.	l/s	cfm	in.	mm	in.	
MULTI-DRILLS - PISTOL																
A	DR350-P5500-QR	205 147 984 4	5500		0.35	0.5	0.50	1.10	169	6.65	9.5	20	1/4	6	1/4	
A	DR350-P3000-QR	205 147 528 4	3000		0.35	0.5	0.50	1.10	169	6.65	9.5	20	1/4	6	1/4	
A	DR350-P1000-QR	205 147 981 4	1000		0.35	0.5	0.58	1.27	187	7.36	9.5	20	1/4	6	1/4	

Other speed on request (550, 2000 & 4500 rpm)

MULTI-DRILLS - STRAIGHT																
B	DR300-T5500-QR	205 147 527 4	5500		0.3	0.4	0.50	1.10	186	7.32	9.5	20	1/4	6	1/4	
B	DR300-T4500-QR	205 147 526 4	4500		0.3	0.4	0.50	1.10	186	7.32	9.5	20	1/4	6	1/4	
B	DR300-T3000-QR	205 147 525 4	3000		0.3	0.4	0.50	1.10	186	7.32	9.5	20	1/4	6	1/4	
B	DR300-T2000-QR	205 147 524 4	2000		0.3	0.4	0.50	1.10	186	7.32	9.5	20	1/4	6	1/4	
C	DR300-T1000-QR	205 147 523 4	1000		0.3	0.4	0.58	1.27	203	7.99	9.5	20	1/4	6	1/4	
C	DR300-T550-QR	205 147 522 4	550		0.3	0.4	0.58	1.27	203	7.99	9.5	20	1/4	6	1/4	

PIC REF	DESIGNATION	PART NUMBER	LENGTH		COLLET MAX. CAPACITY		WEIGHT	
			mm	in.	mm	in.	kg	lb

ANGLE HEADS

D	Short Compact 90° angle head - Collet spindle	205 053 981 3	54.0	2.13	5.0	3/16	0.15	0.33
D	Compact 90° angle head - Collet spindle	205 050 331 3	72.0	2.83	5.0	3/16	0.17	0.37
D	Compact 90° angle head - 1/4" x 28 spindle	205 050 332 3	72.0	2.83			0.17	0.37
E	Compact 30° angle head - Collet spindle	205 050 329 3	82.9	3.26	5.0	3/16	0.17	0.37
E	Compact 30° angle head - 1/4" x 28 spindle	205 050 330 3	82.9	3.26			0.17	0.37
F	Compact 45° angle head - Collet spindle	205 050 335 3	81.0	3.19	5.0	3/16	0.17	0.37
F	Compact 45° angle head - 1/4" x 28 spindle	205 050 336 3	79.0	3.11			0.17	0.37
G	Compact 360° angle head - Collet spindle	205 050 333 3	81.5	3.21	5.0	3/16	0.25	0.55
G	Compact 360° angle head - 1/4" x 28 spindle	205 050 334 3	85.2	3.35			0.25	0.55

STANDARD ANGLE HEADS

H	Standard 90° angle head - Collet spindle	205 050 338 3	75.7	2.98	6.4	1/4	0.23	0.51
H	Standard 90° angle head - Collet spindle	205 050 353 3	75.7	2.98	8.0	5/16	0.23	0.51
H	Standard 90° angle head - 1/4" x 28 spindle	205 050 339 3	75.7	2.98			0.24	0.53
H	Standard 90° angle head - 5/16" x 24 spindle	205 050 340 3	75.7	2.98			0.23	0.51
J	Standard 360° angle head - Collet spindle	205 050 341 3	96.8	3.81	6.4	1/4	0.32	0.70
J	Standard 360° angle head - 1/4" x 28 spindle	205 050 342 3	94.5	3.72			0.32	0.70
J	Standard 360° angle head - 5/16" x 24 spindle	205 050 343 3	94.5	3.72			0.32	0.70

STRAIGHT HEAD

K	Chuck mounting 3/8" x 24	205 050 543 3	32.0	1.26			0.25	0.55
---	--------------------------	---------------	------	------	--	--	------	------

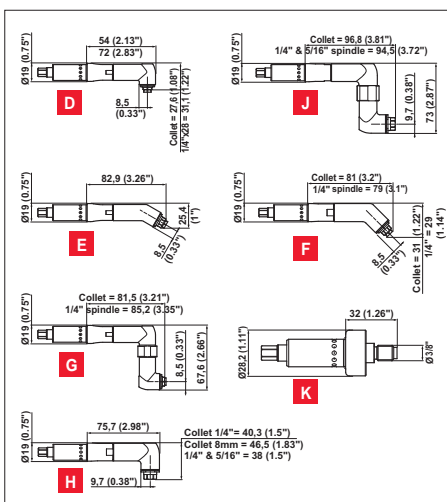

Vacuum for Drills



VACUUM KIT For 90° angle drills		COMPACT	STANDARD
All DR300-T...-T5/S5-90	+	205 147 989 4	
All DR300-T...-T6/S6-90	+		205 147 991 4

VACUUM KIT For Quick release 90° angle head drills		COMPACT	STANDARD	
All DR300-Txxxx-QR	Collet spindle	+	205 050 331 3	205 050 338 3
	1/4" x 28 spindle	+	205 050 332 3	205 050 339 3
	5/6" x 24 spindle	+		205 050 340 3



VACUUM KIT For pistol drill - shroud Ø20mm		DR350	DR500
All DR350/500 and only keyed chick C6 or C8 type	+	205 174 985 4	205 147 987 4



VACUUM KIT For pistol drill - shroud Ø40mm		DR350	DR500
All DR350/500 and only keyed chick C6 or C8 type	+	205 174 986 4	205 147 988 4



COLOUR IDENTIFICATION

ACCESSORIES INCLUDED

COLOUR IDENTIFICATION	DR300 / DR350	
	SPEED	PART NUMBER
	rpm	
Black	20000	205 049 447 3
Orange	5500	205 055 003 3
Purple	4500	205 055 004 3
Blue	3000	205 055 005 3
Red	2000	205 055 006 3
Green	1000	205 055 007 3
Yellow	550	205 055 008 3
Grey	-	-

OPTIONAL ACCESSORIES

COLOUR IDENTIFICATION	DR500		DR750	
	SPEED	PART NUMBER	SPEED	PART NUMBER
	rpm		rpm	
Black	18500	205 050 272 3	20000	473043
Orange	5800	205 055 368 3	6000	205 055 375 3
Purple	4300	205 055 369 3	4100	205 055 376 3
Blue	2700	205 055 370 3	3300 2700	205 055 377 3
Red	1800	205 055 371 3	-	-
Green	1400 1000	205 055 372 3	1300	205 055 378 3
Yellow	600	205 055 373 3	750	205 055 379 3
Grey	400	205 055 374 3	400	205 055 380 3

Tappers

Accessories: see page 188

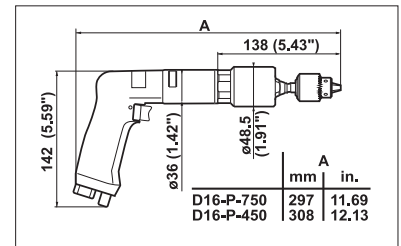

PIC REF	MODEL	PART NUMBER	FREE SPEED	REVERSE SPEED	CHUCK SIZE		MAX. TAPPING TORQUE		WEIGHT		AIR FLOW		AIR INLET		HOSE INT. Ø	
			rpm	rpm	mm	in.	Nm	ft.lb	kg	lb	l/s	cfm	in.	mm	in.	

D SERIES

Trigger Start - push/pull reverse

A	D16-P-750	1288084	750	1500	6.5	1/4	6.2	4.57	1.7	3.75	8.5	18	1/4	10	3/8
A	D16-P-450	1287934	450	900	1.00	3/8	11.1	8.18	1.8	3.97	8.5	18	1/4	10	3/8

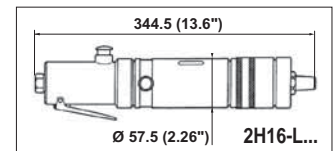

PIC REF	MODEL	PART NUMBER	LOW SPEED SETTING	HIGH SPEED SETTING	MAX. TAPPING TORQUE LOW SPEED		MAX. TAPPING TORQUE HIGH SPEED		WEIGHT		AIR FLOW		AIR INLET		HOSE INT. Ø	
			rpm	rpm	Nm	ft.lb	Nm	ft.lb	kg	lb	l/s	cfm	in.	mm	in.	

H SERIES

Lever Start - button reverse - stand mounted

B	2H16-L-250/800 - B18	1434184	250	800	90	66.4	29	21.4	3.1	6.8	15.6	33	3/8	10	3/8
B	2H16-L-160/500 - B18	1434264	130	500	140	103.3	47	34.7	3.1	6.8	15.6	33	3/8	10	3/8
B	2H16-L-90/250 - B18	1434344	90	250	240	177.0	90	66.4	3.1	6.8	15.6	33	3/8	10	3/8

Hole Deburring & Rivet Shaving



A



B



C

Accessories: see page 189



PIC REF	MODEL	PART NUMBER	FREE SPEED	COLLET SIZE	MAXIMUM CUTTER DIA.		WEIGHT		LENGTH		AIR FLOW		AIR INLET		HOSE INT. Ø	
			rpm	mm	mm	in.	kg	lb	mm	in.	l/s	cfm	in.	mm	in.	

HOLE DEBURRING TOOLS – PUSH TO START

(integral speed regulator)

A	A27-A-1300	1406594	100 - 1300	4	-	-	0.24	0.52	172	6.77	2.4	5.0	M5	3	1/8
B	C27-AX-1450	1405414	100 - 1450	6	-	-	0.48	1.05	218	8.58	6.2	13.0	1/4	6	1/4

RIVET SHAVER (for accessory 1/4"-26 WHIT)

C	RS500-P18500	205 148 130 4	18500	-	14.3	9/16	1.2	2.6	212	8.35	14	30	1/4	10	3/8
---	--------------	---------------	-------	---	------	------	-----	-----	-----	------	----	----	-----	----	-----

RIVET SHAVER (for accessory 1/4"-28 UNF)

C	RS500-P18500	205 148 129 4	18500	-	14.3	9/16	1.2	2.6	212	8.35	14	30	1/4	10	3/8
---	--------------	---------------	-------	---	------	------	-----	-----	-----	------	----	----	-----	----	-----

Accessories

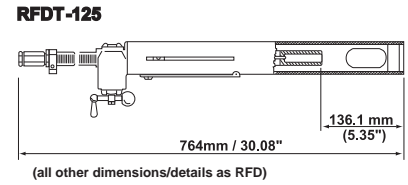
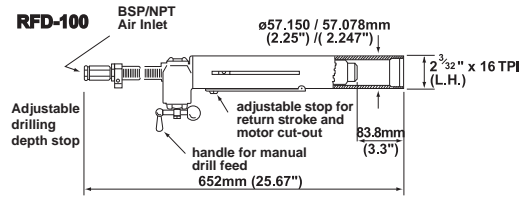

RFD-100 / RFDT-125

ACCESSORIES INCLUDED

	PART NO.	
	RFD	RFDT
• Chuck 1/2" UNF cap. 13mm (1/2") (with key)	29142	
• Chuck 5/8" UNF cap. 13mm (1/2") (with key)	29122	
• Extended Nose (1" x 14 TPI LH nose thread)	251043	
• Bayonet Plate – 45mm (1.77") centres	251063	
• Bayonet Plate – 76mm (2.99") centres		35323

OPTIONAL ACCESSORIES

	PART NO.
	RFD
• Chuck Key	29242

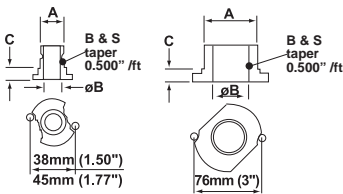

Bayonet Plates

	'A'	'ØB'	'C'	PART NO.
• Locating centres – 38mm (1.50")	3/4" x 16 TPI (LH)	14.2mm (0.559")	9.5mm (3/8")	251053
• Locating centres – 45mm (1.77")	1" x 14 TPI (LH)	19.05mm (3/4")	9.5mm (3/8")	251063
• Locating centres – 45mm (1.77")	1-1/8" x 20 TPI (LH)	19.05mm (3/4")	9.5mm (3/8")	31113
• Locating centres – 76mm (2.99")	2-3/32" x 16 TPI (LH)	38.1mm (1.150")	12.7mm (1/2")	35323

Nose Attachment 1

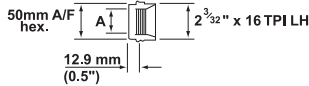

Nose Attachment 2

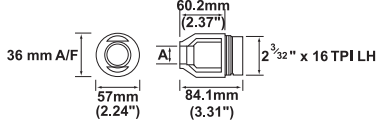

Nose Attachment 3

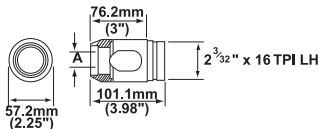

Nose Attachments

Nose type	To suit bayonet plate centres	Thread 'A'	PART NO.
1	38mm (1.50")	3/4" x 16 TPI (LH)	235773
2	38mm (1.50")	3/4" x 16 TPI (LH)	251033
2	45mm (1.77")	1" x 14 TPI (LH)	251043
3	–	1-1/4" x 12 TPI (LH)	235213
3	–	1-1/2" x 12 TPI (LH)	235223
3	–	2" x 16 TPI (LH)	235343

Extension Tubes

Nominal stroke available to drill	Length 'A'	PART NO.
80mm / (3.15")	170mm / (6.69")	250923

Jig Plates

Centres 'A'	PART NO.	
	LOCATING STUD	SCREW
38mm (1.50")	17632	17642
45mm (1.77")	17632	17642

For dimension 'ØB' please ask for details of our range of drill bushes

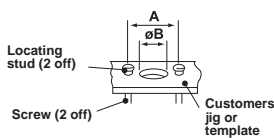

1. Push nose into jig



2. Give quarter turn counter clockwise to lock

Rack Feed Drills

- The Rack Feed Drill is a semi-fixtured (nose mounted) portable drilling unit, utilising a manual feed through an integral "rack and pinion" mechanism to accommodate the approach drilling and retract cycles. This provides the user with complete control of the feed rate during drilling and allows the user to "feel" the feed rate required. Versatile and flexible, especially when drilling laminates and sandwich materials
- RFD is suitable for drilling/reaming various materials used in the Aerospace industries e.g. Inconel, Titanium, Steel, Aluminium and Composites
- A wide speed range from 60 rpm to 2800 rpm is available allowing the best speed to be selected to suit the application
- RFD-100 provides 102mm (4") of adjustable working stroke length with a 13mm (1/2") chuck capacity
- RFDT-125 provides 127mm (5") of adjustable working stroke length with a No. 2 Morse Taper drive spindle
- Automatic motor start/stop – can be set to operate at any point within stroke setting for maximum economy of air
- Various nose configurations can be provided



RFD Selection

DRILL Ø	MATERIAL			
	Inconel	Titanium	Mild steel	Aluminium
	Tool type – rpm			
3mm 1/8"	RFD-330/500 RFDT-330/500	RFD-500 RFDT-500	RFD-2800	RFD-2800
5mm 3/16"	RFD-140/330 RFDT-140/330	RFD-330/500 RFDT-330/500	RFD-1850	RFD-2800
6mm 1/4"	RFD-140 RFDT-140	RFD-140/330 RFDT-140/330	RFD-800 RFDT-800	RFD-1850
8mm 5/16"	RFD-140 RFDT-140	RFD-140/330 RFDT-140/330	RFD-800 RFDT-800	RFD-800 RFDT-800
10mm 3/8"	RFD-85/140 RFDT-85/140	RFD-140 RFT-140	RFD-800 RFDT-800	RFD-800 RFDT-800
13mm 1/2"	RFD-60/85 RFDT-60/85	RFD-85/140 RFDT-85/140	RFD-500 RFDT-500	RFD-800 RFDT-800
16mm 5/8"		RFD-85/140 RFDT-85/140	RFD-330 RFDT-330	RFD-800 RFDT-800
19mm 3/4"		RFD-60/85 RFDT-60/85	RFD-85/140 RFDT-85/140	RFD-330/500 RFDT-330/500
25mm 1"			RFD-60/85 RFDT-60/85	RFD-140/330 RFDT-140/330

Use selection data as a guide only

MODEL	PART NUMBER	FREE SPEED	MAX STROKE		OUTPUT SPINDLE	WEIGHT		AIR CONSUMPTION		AIR INLET	HOSE INT. Ø	
			mm	in.		kg	lb	l/s	cfm		mm	in.
RFD-100-2800*	681214	2800	102	4		3.9	8.6	11.8	25	1/4	10	3/8
RFD-100-1850*	681394	1850	102	4		3.9	8.6	11.8	25	1/4	10	3/8
RFD-100-800**	680084	800	102	4	Chuck	3.9	8.6	11.8	25	1/4	10	3/8
RFD-100-500**	680164	500	102	4	13mm	3.9	8.6	11.8	25	1/4	10	3/8
RFD-100-330**	680244	330	102	4	1/2"	3.9	8.6	11.8	25	1/4	10	3/8
RFD-100-140**	1457364	140	102	4	capacity	3.9	8.6	11.8	25	1/4	10	3/8
RFD-100-85**	1457374	85	102	4		3.9	8.6	11.8	25	1/4	10	3/8
RFD-100-60**	1457384	60	102	4		3.9	8.6	11.8	25	1/4	10	3/8
RFDT-125-800	1445654	800	127	5		5.5	12.1	11.8	25	1/4	10	3/8
RFDT-125-500	1445664	500	127	5	No. 2	5.5	12.1	11.8	25	1/4	10	3/8
RFDT-125-330	1445674	330	127	5	Morse	5.5	12.1	11.8	25	1/4	10	3/8
RFDT-125-140	1445504	140	127	5	Taper	5.5	12.1	11.8	25	1/4	10	3/8
RFDT-125-85	1445514	85	127	5		5.5	12.1	11.8	25	1/4	10	3/8
RFDT-125-60	1445524	60	127	5		5.5	12.1	11.8	25	1/4	10	3/8

Chuck spindle: * 1/2"-20 UNF / ** 5/8"-16 UNF

Accessories for Pistol & Straight Grip Drills

DR350-P... / DR500-P... / DR750-P...

ACCESSORIES INCLUDED



ITEM	DR350-P...C8	DR350-P...C10	DR500-P...C13
	DR500-P...C8	DR500-P...C10	DR750-P...C13
1 Keyed chuck 3/8" UNF - cap. 8mm (5/16") (with key)	205 053 013 3		
1 Keyed chuck 3/8" UNF - cap. 10mm (3/8") (with key)		205 052 954 3	
1 Keyed chuck 3/8" UNF - cap. 13mm (1/2") (with key)			473113
1 Keyed chuck 1/2" UNF - cap. 13mm (1/2") (with key)			29142
• Chuck Key	410213	29232	29242
2 Chuck Guard (for DR350-P...C8)	205 049 275 3		
2 Chuck Guard (for DR500-P...C8)	205 049 486 3		
2 Chuck Guard (for DR750-P...C8 & C10)	473143	473133	
3 Side Handle *supplied with the DR350-P550.. & DR350-P1000..	205 049 446 3*	205 049 446 3*	
3 Side handle *supplied with DR500-P400 to P1800		205 053 102 3*	205 053 102 3*
3 Side handle (for DR750-P...)	473173	473173	473173
• Suspension Bail (for DR750-P...)	473153	473153	473153

OPTIONAL ACCESSORIES

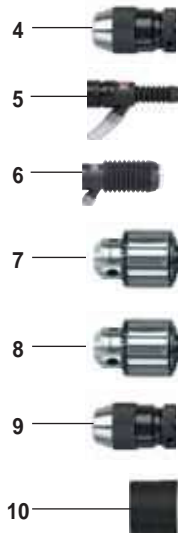

ITEM	DR350-P...	DR500-P...	DR750-P.	DR750-P. JT1 MOUNT
	• Sleeve - JT1 female to JT2 male			
3 Side Handle	205 049 446 3	205 053 102 3		
4 Keyless Chuck threaded 3/8"UNF - cap. 8mm (5/16")	473433	473433	473433	
4 Keyless Chuck threaded 3/8"UNF - cap. 10mm (3/8")		473423	473423	
4 Keyless Chuck threaded 3/8"UNF - cap. 13mm (1/2")			205 047 819 3	
4 Keyless Chuck threaded 1/2"UNF - cap. 13mm (1/2")			205 056 060 3	
5 Vacuum kit for pistol drill - shroud ø 20mm (for C6 or C8 type)	205 147 985 4	205 147 987 4		
6 Vacuum kit for pistol drill - shroud ø 40mm (for C6 or C8 type)	205 147 986 4	205 147 988 4		
7 Keyed chuck 3/8"UNF - cap. 6.5mm (1/4")	205 055 272 3	205 055 272 3	205 055 272 3	
• Chuck key	29182	29182	29182	
• Flat wrench, 12.7mm (1/2")			15533	
8 Keyed chuck with key (29182) - cap. 6.5mm (1/4")				29492
8 Keyed chuck with key (29232) - cap. 10mm (3/8")				29042
9 Keyless Chuck - cap. 6.5mm (1/4")				524.09
9 Keyless Chuck - cap. 10mm (3/8")				524.15
10 Chuck Guard - use with chuck with key - cap. 6.5mm (1/4")				473143

DR300-T...

ACCESSORIES INCLUDED



ITEM	DR300-T...C8	DR300-T...C10
	1 Safety lever	205 050 288 3
2 Keyed chuck 3/8"UNF - cap. 8mm (5/16") (with key)	205 053 013 3	
2 Keyed chuck 3/8"UNF - cap. 10mm (3/8") (with key)		205 052 654 3
• Chuck key	410213	29232
3 Chuck Guard	205 049 275 3	
• Exhaust hose (with clamp ring)	205 051 259 3	205 051 259 3
4 Side handle		205 049 446 3

OPTIONAL ACCESSORIES

ITEM	DR300-T...C8	DR300-T...C10
	5 Keyless Chuck threaded 3/8"UNF - cap. 8mm (5/16")	473433
6 Suspension Bail (for vertical tool suspension)	39433	39433
4 Side handle	205 049 446 3	
7 Short lever	205 050 299 3	205 050 299 3
8 Inlet button with lever recess plugs	205 050 453 3	205 050 453 3

Accessories for Angle Drills

DR300-...-T5-90/-S5-90/-T6-90/-S6-90 DR300-...-T5-30/-45/-S5-30/-45 DR300-...-T5-360/-S5-360/-T6-360/-S6-360 D3141-S/-L / D3143-S/-L



ACCESSORIES INCLUDED

ITEM	DR300-T5-90	DR300-T6-90	DR300-S5-90		D3141-S	D3143-S
	DR300-T5-30/-45/-360	DR300-T6-360	DR300-S5-30/-45/-360	DR300-S6-90/-360	D3141-L	D3143-L
	2552	19182			2872	
1 Chuck threaded 3/8" UNF - cap. 8mm (5/16") (with key)						410203
2 Standard lever					305893	305893
3 Safety lever	205 050 288 3	205 050 288 3	205 050 288 3			
• Exhaust hose with clamp ring	205 050 746 3	205 050 746 3	205 050 746 3		205 050 746 3	
• Chuck key						410213
• Flat wrench 8-9.5mm	268263					
• Flat wrench 10mm		82623				



OPTIONAL ACCESSORIES

ITEM	DR300-T5-30/-45/-90/-360	DR300-T6-90/-360	D3141-S	D3143-2
	DR300-S5-30/-45/-90/-360	DR300-S6-90/-360	D3141-L	D3143-L
4 Inlet button with lever recess plugs	205 050 454 3	205 050 454 3	205 050 454 3	
5 Vacuum kit for 90° angle head - Compact	205 147 989 4			
5 Vacuum kit for 90° angle head - Standard		205 147 991 4		
6 Side handle	205 049 446 3	205 049 446 3		
7 Short lever	205 050 299 3	205 050 299 3	410303	410303
8 Safety lever			323893	323893

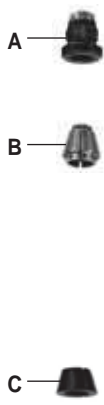

Collet capacity	DR300-T5-90	DR300-T6-90	D3141-S	Collet capacity	DR300-T5-90	DR300-T6-90	D3141-S
	T5-30/-45/-360	T6-360	D3141-L		T5-30/-45/-360	T6-360	D3141-L
	A	B	C		A	B	C
• ø 0.8mm	2152			• ø 4.0mm (5/32")	2472	19052	2672
• ø 0.9mm	2162			• ø 4.1mm	2482		
• ø 1.0mm	2172			• ø 4.2mm	2492	19062	2682
• ø 1.1mm	2182			• ø 4.3mm	2502		
• ø 1.2mm	2192			• ø 4.4mm	2512	19072	2692
• ø 1.3mm	2202			• ø 4.5mm	2522		
• ø 1.4mm	2212			• ø 4.6mm	2532	19082	2702
• ø 1.5mm	2222			• ø 4.7mm	2542		
• ø 1.6mm	2232	18922		• ø 4.8mm (3/16")	2552	19092	2712
• ø 1.7mm	2242			• ø 4.9mm	2562		
• ø 1.8mm	2252	18932		• ø 5.0mm	2572	19102	2722
• ø 1.9mm	2262			• ø 5.2mm		19122	2732
• ø 2.0mm	2272	18942		• ø 5.4mm		19132	2742
• ø 2.1mm	2282			• ø 5.6mm		19142	2752
• ø 2.2mm	2292	18952		• ø 5.8mm		19152	2762
• ø 2.3mm	2302			• ø 6.0mm		19162	2772
• ø 2.4mm (3/32")	2312	18962	2592	• ø 6.2mm		19172	2782
• ø 2.5mm	2322			• ø 6.4mm (1/4")		19182	2792
• ø 2.6mm	2332	18972	2602	• ø 6.6mm			2802
• ø 2.7mm	2342			• ø 6.8mm			2812
• ø 2.8mm	2352	18982	2612	• ø 7.0mm			2822
• ø 2.9mm	2362			• ø 7.2mm (9/32")			2832
• ø 3.0mm	2372	18992	2622	• ø 7.4mm			2842
• ø 3.1mm	2382			• ø 7.6mm			2852
• ø 3.2mm (1/8")	2392	19002	2632	• ø 7.8mm			2862
• ø 3.3mm	2402			• ø 8.0mm (5/16")			2872
• ø 3.4mm	2412	19022	2642	• ø 1/16"	91442		
• ø 3.5mm	2422			• ø 3/32"	91452		
• ø 3.6mm	2432	19032	2652	• ø 1/8"	91462		
• ø 3.7mm	2442			• ø 5/32"	91472		
• ø 3.8mm	2452	19042	2662	• ø 11/64"	108172		
• ø 3.9mm	2462			• ø 3/16"	91482		

A threaded 9/32"x 40

Accessories for Tappers

D16-P-...

ACCESSORIES INCLUDED

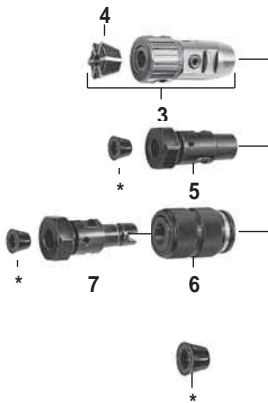

ITEM	D16-P-750	D16-P-450
1 Chuck (Jacobs No. 1 taper) - cap. 6.5mm (1/4") (with key)	29492	
1 Chuck (Jacobs No. 1 taper) - cap. 10mm (3/8") (with key)		29042
• Chuck key	29182	29232
• Screw for chuck (L = 20.6mm)	12233	12233
2 Exhaust hose (except D16-P-..)	222453	222453
• Clamp	235203	235203

OPTIONAL ACCESSORIES

ITEM	PART NO.
3 Precision collet tap holder (with collet 29472) (1 JT)	29452
4 Collet capacity M4 to M8 (5/32" to 5/16")	29472
4 Collet capacity M3 to M7 (1/8" to 9/32")	29482
4 Collet capacity M6 to M12 (15/64" to 15/32")	97982
5 *Tap Holder (1 JT)	69922
6 Quick Release Chuck	16852
7 *Quick Release Tap Holder	69872

*Collets for Tap Holders:

TAP SIZE	SHANK DIA			PART NO.
	mm	in.	BA	
• M2.2 & M2.5			6 & 8	2612
• M3		1/8"	5	2632
• M3.5			4	2652
• M4			0	2672
• M4.5			3	2702
• M5		3/16"	2	2722
• M5.5		7/32"	1	2752
• M6		1/4"	0	2792
• M7		9/32"		2832
• M8 & M11		5/16" & 7/16"		2872
• M9 & M12		1/2"		69882
• M10		3/8"		69892
• *Wrench for Tap Holder collet nut				29443
• *2mm A/F hexagon key for Tap Holder grub screws				206773

Accessories for Hole Deburring & Rivet Shaving

A27-A-... / C27-AX-... / RS500-T...

ACCESSORIES INCLUDED

ITEM	PART NO.		
	A27-A	C27-AX	RS500
• ø 3mm capacity collet - 9/32" x 40 Treaded	2372		
• ø 4mm (5/32") capacity collet - 9/32" x 40 Treaded	2472		
• ø 6.4mm (1/4") capacity collet		615 526 059 0	
1 Cutter (90° point) – 5mm dia	91752		
1 Cutter (90° point) – 10mm dia		91572	
2 Cutter – carbide tipped (11.1mm 7/16" dia)			70602
3 Cutter Guard			18822
• Air Hose (M5 x 1/8" BSP) – 4mm bore	79322		
• Adaptor (1/8" BSP female to 1/8" NPT male)	271463		
• Suspension Bail	280903	39433	
• Exhaust hose	280913	222453	
• Exhaust Hose Clip		235203	
• Collet Nut Wrench	82623	18583	
• Collet Spindle Wrench	268263	159003	15533
• Cutter Guard Wrench			38873
• Bit stop		322053	

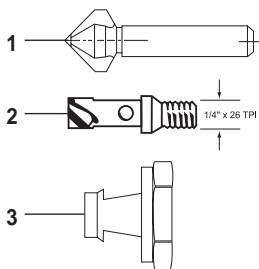

OPTIONAL ACCESSORIES

ITEM	PART NO.	
	A27-A	RS500
2 Cutter – carbide tipped ø6.4mm (ø1/4")		70572
2 Cutter – carbide tipped ø7.9mm (ø5/16")		70582
2 Cutter – carbide tipped ø9.5mm (ø3/8")		70592
2 Cutter – carbide tipped ø12.7mm (ø1/2")		70622
3 Cutter Guard ø6.4mm (ø1/4")		18782
3 Cutter Guard ø7.9mm (ø5/16")		18792
3 Cutter Guard ø9.5mm (ø3/8")		18802
3 Cutter Guard ø12.7mm (ø1/2")		18832
3 Cutter Guard ø14.3mm (ø9/16")		18842

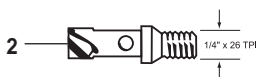

Drilling Accessories

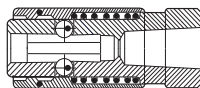

SCREWDRIVER BIT ADAPTOR

TAPER	INSIDE HEX	NOTES	PART NO.
Jacobs No 1	5/16 Hex	Quick release	27742
Jacobs No 1	1/4" Hex	Quick release	31102



TAPER ADAPTOR

TAPER	TAPER	NOTES	PART NO.
Jacobs No 1	Jacobs No 2		12243

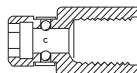

SCREWDRIVER BIT ADAPTOR

INSIDE THREAD	TAPER/INSIDE HEX	NOTES	PART NO.
3/8" x 24	1/4" Hex E6.3	Positive retention	615 804 419 0

ADU - Advanced Drilling Unit

The Seti-Tec line of products are specifically related to Semi Automated Drilling Operations, dedicated to aeronautic engineering and assembly equipment.

Standardized Technical Architecture

Same modularity are duplicated into 2 main types of machines, ST1200 and ST2200, both dedicated to different holes sizes.

Same maintenance plans and procedures for all Seti-Tec machines.

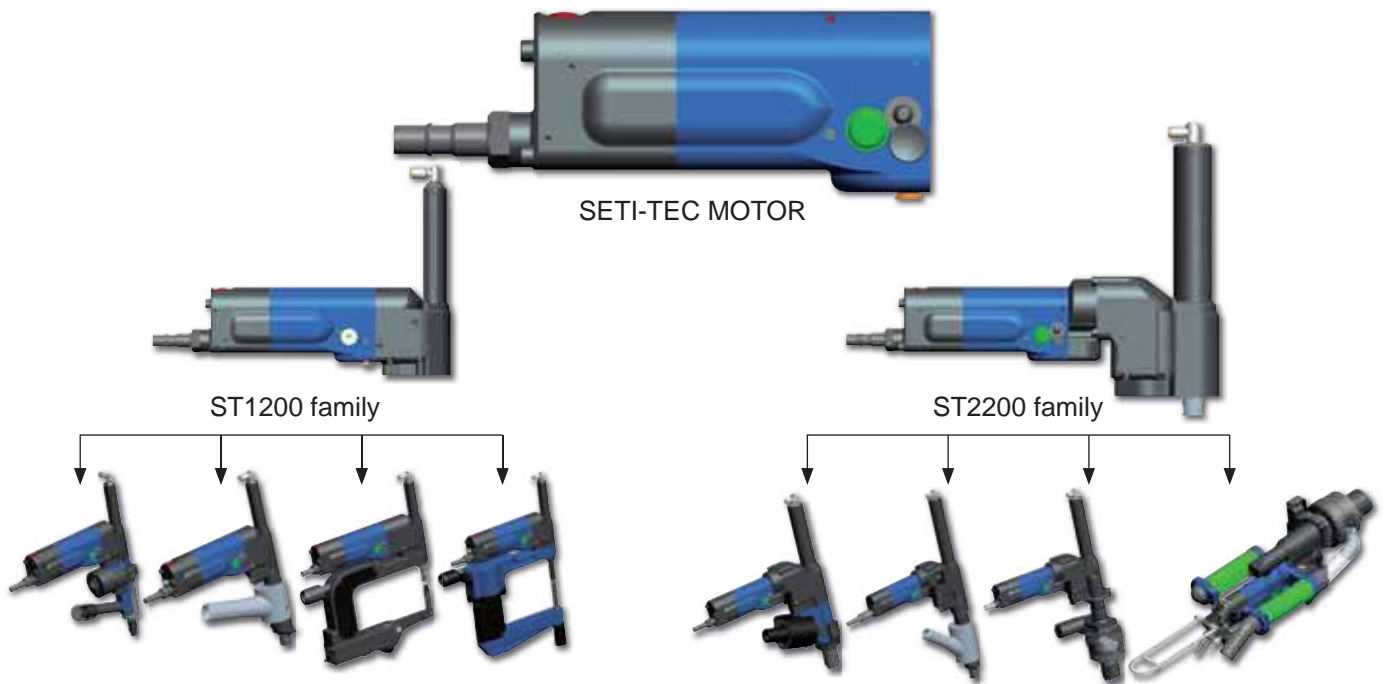

Global Machine Concept - ST1200 and ST2200

The SETI-TEC line of products offer a complete automated cycle.

One push on the start button and the machine is launched for one full cycle to a chosen spindle rotation and feed rate, when the adjustable spindle stop is reached the spindle retracts and the machine stops.

All products have an Emergency Stop Button to stop cycle and a Manual Spindle Retract Button.

All products can be fitted with an electronic cycle counter.

All products can be fitted with or without MICROPECK drilling solution.

All products can be fitted with or without Cutting Lubrication.

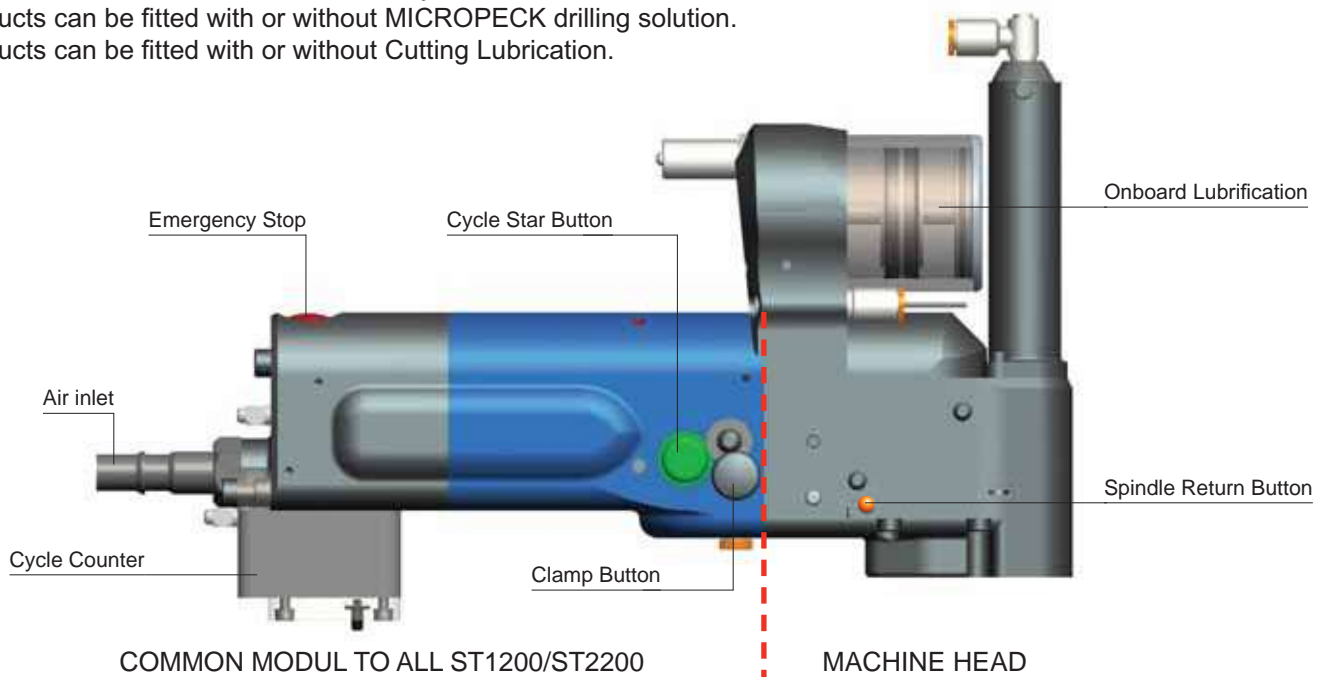

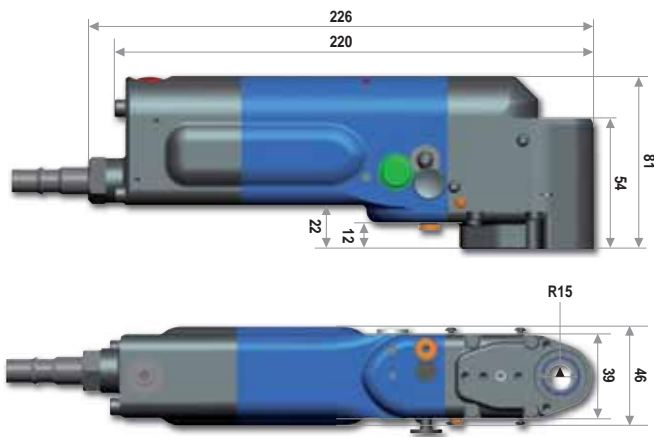

NEW ST1200 detailed presentation

Type: Automatic positive feed drill
Drill and countersink, precision depth 0.02mm (0.0008")

Power: 2.8 HP, with torque limiter at lower speed

Weight: 1.5 kg (3.3lb)

Stroke: No restriction

Feed rate: 0.02 mm (0.0008")/rotation
0.04 mm (0.0016")/rotation
0.06 mm (0.0024")/rotation
0.08 mm (0.0032")/rotation
0.10 mm (0.0040")/rotation
0.12 mm (0.0048")/rotation
0.15 mm (0.0060")/rotation

Higher feed rates possible.

Rotation speed: 240 rpm
1 000 rpm
1 700 rpm
2 400 rpm
3 000 rpm
4 600 rpm
6 500 rpm
8 100 rpm

Available inline and angle head models.



NEW ST2200 detailed presentation

Type: Automatic positive feed drill
Drill and countersink, precision depth 0,02mm (0.0008")

Power: 2.8 HP, with high torque at low speed

Weight: 4.2 kg (9.2lb)

Stroke: No restriction

Feed rate: 0.04 mm (0.0016")/rotation
0.06 mm (0.0024")/rotation
0.10 mm (0.0040")/rotation
0.12 mm (0.0048")/rotation
0.14 mm (0.0056")/rotation
0.18 mm (0.0072")/rotation
0.20 mm (0.0080")/rotation

Higher feed rates possible.

Rotation speed: 159 rpm
300 rpm
540 rpm
700 rpm
800 rpm
900 rpm
1 200 rpm
2 600 rpm

Available inline and angle head models.



Concentric Collet Range

Concentric collet on ST1200 machine base: ST1220

Small size Concentric Collet adapted to up 9.5mm (3/8") drilling + countersink

Onboard or Outboard Lubrication

Vacuum dust extraction

Compact, Lightweight and Ergonomic



Concentric collet on ST2200 machine base: ST2220

Large size Concentric Collet from 9.5mm (3/8") drilling + countersink

Onboard or Outboard Lubrication

Integrated vacuum pipe for compact solution

Bearing guided spindle on each side of the head for an overall compact machine.

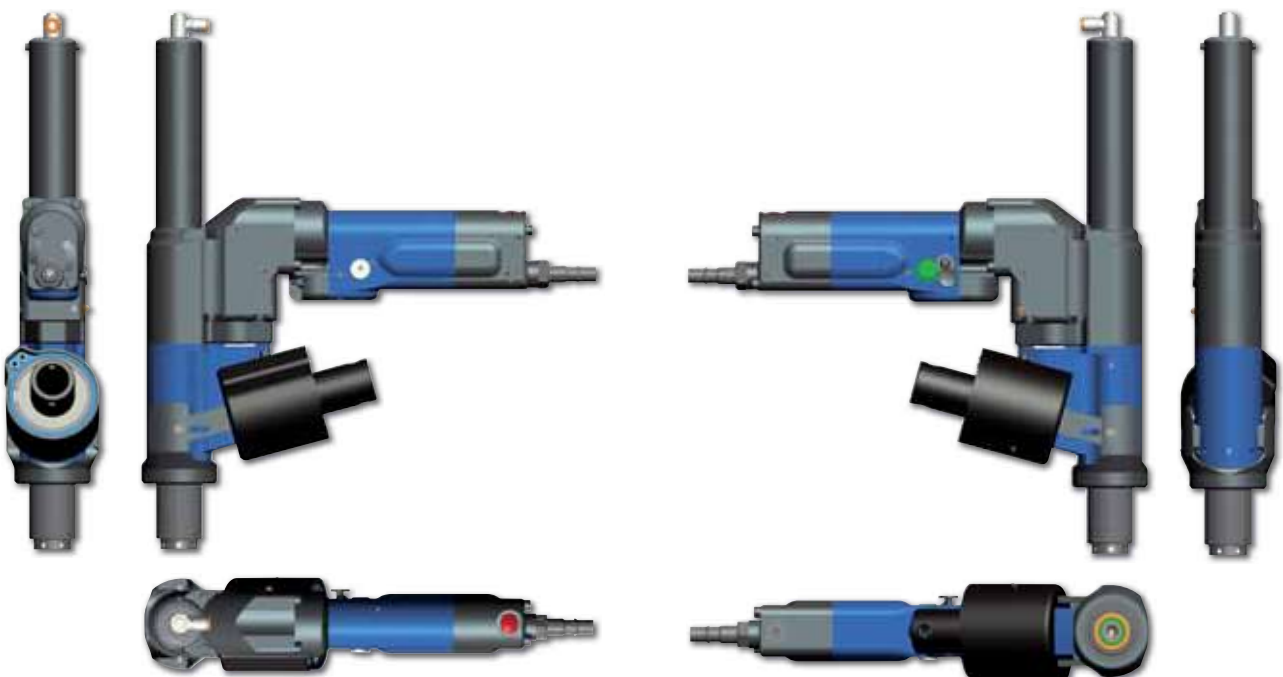

Contact your Desoutter representative for assistance

Bayonet Range

Bayonet on ST1200 machine base: ST1210

Small size drilling to up 9.5mm (3/8") + countersink
Onboard or Outboard Lubrication (not shown on picture)
Vacuum dust extraction
Compact, Lightweight and Ergonomic

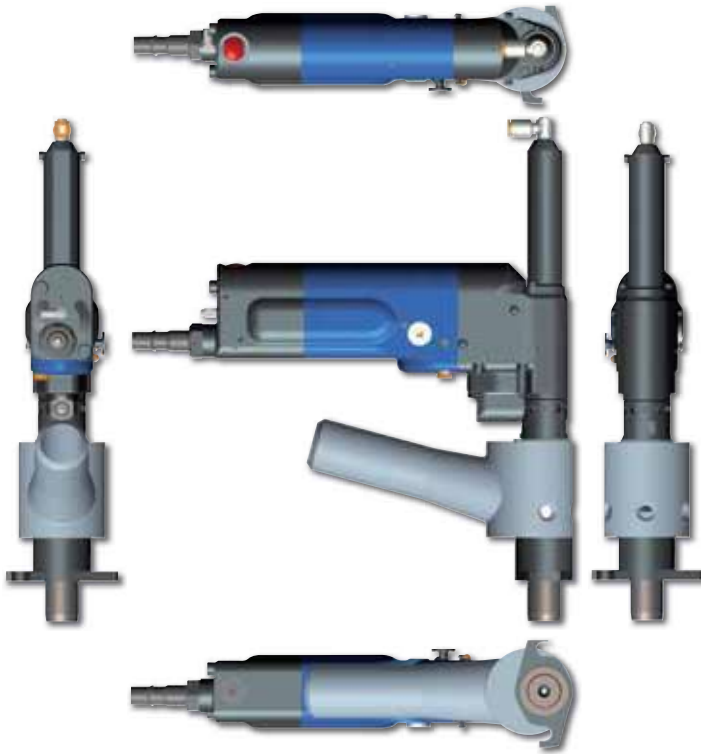

Bayonet on ST2200 machine base: ST2210



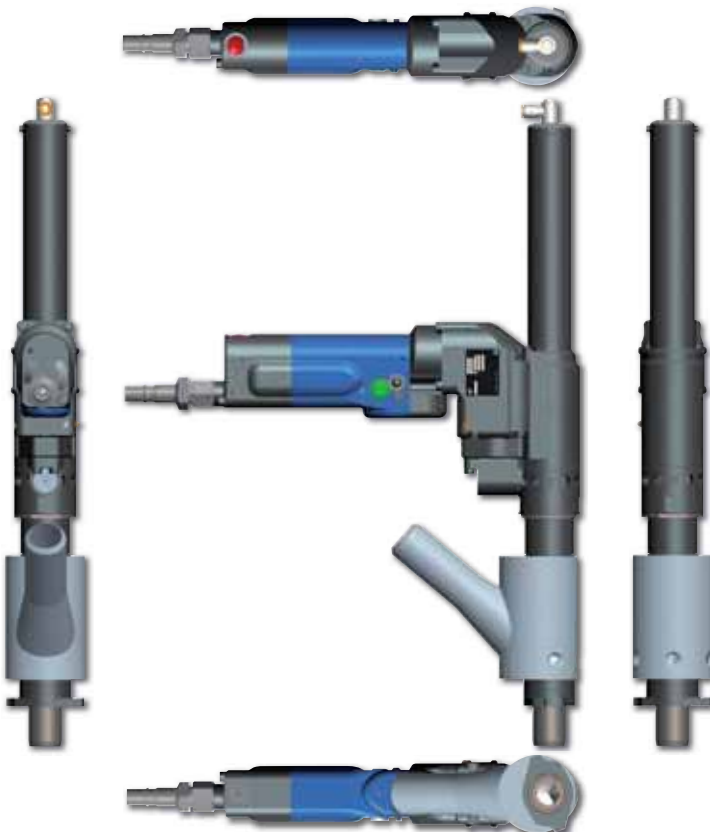



Large size drilling from 9.5mm (3/8") + countersink
Onboard or Outboard Lubrication
(not shown on picture)
Vacuum dust extraction
Lightweight and Ergonomic

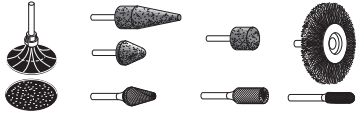

Contact your Desoutter representative for assistance

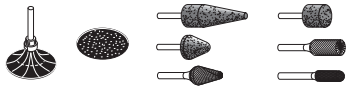
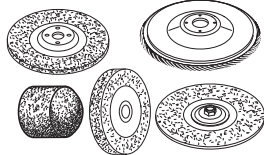
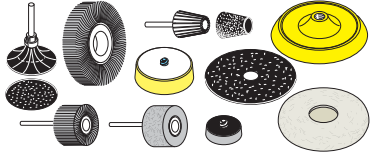

Removal Tools - Selection Guide

TOOL TYPE	ACCESSORIES	PAGE
GRINDERS: for carbide burrs, mounted points & sanding discs		196-203
ROUTERS		204
COLLET GRINDER ACCESSORIES		205
GRINDERS: for cone wheels, type 1 wheels, depressed center wheels, cut-off wheels, diamond discs, flap wheels		206-221
SANDERS: for expandable wheels, flap wheels, brushes, abrasive discs		222-231
DUST EXTRACTION SYSTEMS: for straight and angle grinders for angle and vertical sanders		232-239
RANDOM ORBITAL SANDERS AND POLISHERS: for abrasive discs and polishing accessories ORBITAL SANDERS: for abrasive sheets		240-251
BELT SANDERS		252-253



Accessories

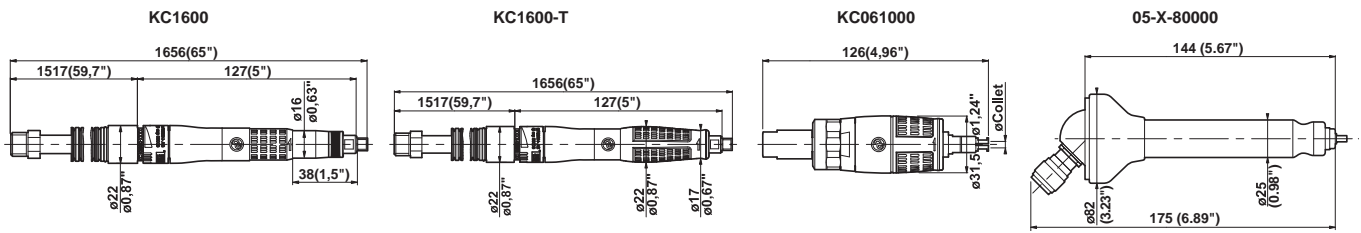

KC1600-T / KC1600

ACCESSORIES INCLUDED

ITEM	PART NO.
• Collet \varnothing 3 mm	205 047 961 3
1 Exhaust kit - L = 1m (39.4")	615 396 405 0
2 Mounted inlet hose 1/4" BSP - \varnothing 6mm (1/4") - L = 1.5m (59")	615 875 119 0
• Spanner (Qty 2)	205 047 965 3
• Carrying case (for T version only)	P137979

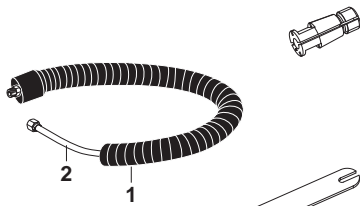

OPTIONAL ACCESSORIES

ITEM	PART NO.
• Collet \varnothing 2.38 mm (3/32")	205 048 059 3
3 Machine extension - L = 150mm (5.9")	615 595 330 0
4 Collet extension - L = 20mm (0.79")	615 595 329 0
5 Adaptor 1/4" BSP - 1/4" NPT female	181523

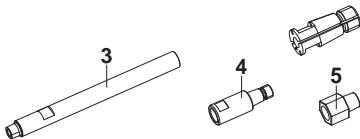

KC061000 / 05-X-80000

ACCESSORIES INCLUDED

ITEM	KC061000	05-X-80000
• Collet \varnothing 3 mm	205 047 961 3	9812
1 Complete inlet hose 1/8" M - 1/4" M, \varnothing 5mm (3/16") L = 2.40m (94.5")	P043886	
1 Complete inlet hose 1/4" M - 1/8" M-BSP, \varnothing 5mm (3/16") L = 3m (118")		75922
2 Filter 1/4" F-1/4" M. NPT	P056381	
• Spanner (Qty 2)	205 047 965 3	

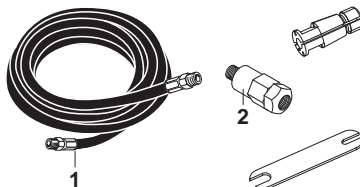

OPTIONAL ACCESSORIES

	KC061000	05-X-80000
• Collet \varnothing 2.38mm (3/32")	205 048 059 3	9792



Grinders for carbide

burrs and mounted points

44 to 100 Watts (0.06 to 0.13 hp) - 60000 to 100000 rpm



Caution: comply with the speeds recommended by component and abrasive manufacturers.

PIC REF	MODEL	PART NUMBER	FREE SPEED	COLLET MAX CAPACITY		POWER		WEIGHT		AIR CONSUMPTION		AIR INLET. THREAD	HOSE INT. Ø	
			rpm	mm	in.	W	hp	kg	lb.	l/s	cfm	in.	mm	in.

PENCIL DIE GRINDERS

A	KC1600-T	615 170 313 0	60000	3.00		100	0.13	0.15	0.33	4.9	10.4	1/4 BSP	6	1/4
B	KC1600	615 170 315 0	60000	3.00		100	0.13	0.15	0.33	4.9	10.4	1/4 BSP	6	1/4

TURBINE GRINDERS

C	KC061000	205 146 638 4	100000	3.00		44	0.06	0.24	0.53	8.5	18.0	1/4	5	3/16
D	05-X-80000	258984	80000	3.17	1/8	75	0.1	0.30	0.66	2.8	5.9	1/8	5	3/16

Accessories

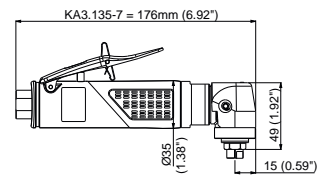
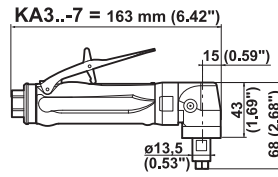
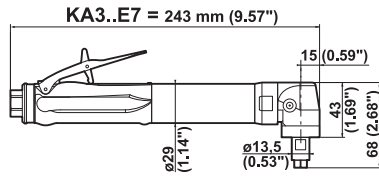
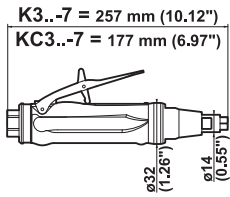

K3..-7 / KC3..-7 / KA3..E7 / KA3..-7 / KA3.135-7

ACCESSORIES INCLUDED

	K3.. / KC3.. KA3..	KA3.135
• CNOMO collet \varnothing 6 mm	615 526 046 0	615 526 079 0
• Exhaust hose L = 0.8m (31")	615 875 106 0	
• 1/4" air hose nipple for 8mm (5/16") ID hose	615 704 019 0	
• 1/4" air hose nipple for 6mm (1/4") ID hose		615 705 009 0
• Flat wrench, 10mm (25/64")	615 801 002 0	615 801 002 0
• Flat wrench, 11mm (7/16")	615 801 003 0	
• Flat wrench, 14mm		615 801 005 0

OPTIONAL ACCESSORIES

ITEM	A K3.. / KC3.. KA3..	B KA3.135
• Collet \varnothing 2 mm		615 526 066 0
• CNOMO collet \varnothing 2.5 mm	615 526 089 0	615 526 068 0
• CNOMO collet \varnothing 3 mm	615 526 044 0	615 526 069 0
• CNOMO collet \varnothing 3.2 mm (1/8")	615 526 045 0	
• Collet \varnothing 3.5mm		615 526 070 0
• CNOMO collet \varnothing 4 mm (5/32")	615 526 090 0	615 526 071 0
• CNOMO collet \varnothing 4.5 mm		615 526 073 0
• CNOMO collet \varnothing 5 mm	615 526 092 0	615 526 075 0
• Collet \varnothing 5.5mm		615 526 077 0
• CNOMO collet \varnothing 6.4 mm (1/4")	615 526 047 0	
• Collet \varnothing 6.5mm		615 526 081 0
• Collet \varnothing 7mm		615 526 083 0
• Collet \varnothing 7.5mm		615 526 084 0
• Collet \varnothing 8mm (5/16")		615 526 088 0
1 Complete silencer kit	615 396 101 0	615 399 423 0
2 Silencer	615 574 028 0	
3 Clippable silencer	615 396 124 0	
4 Exhaust hose L = 0.8m (31")		615 875 106 0
5 Backing pad \varnothing 50mm		615 804 098 0
6 Grease gun (capacity 24g - 0.8 oz.)	615 990 149 0	
• Grease for bevel gear (1kg - 2.2lb)	615 990 148 0	

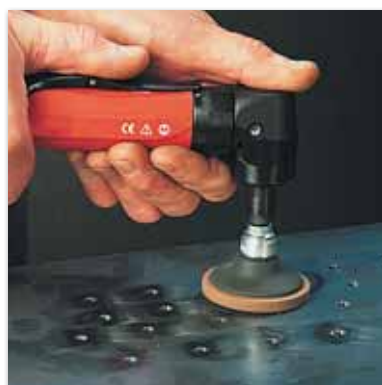
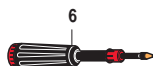
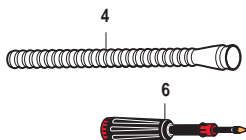
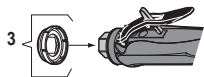
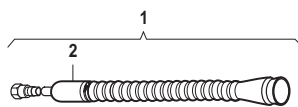
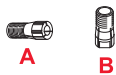
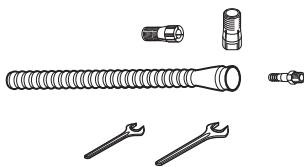

Grinders for carbide burrs, mounted points and sanding discs

300 and 375 Watts (0.4 and 0.5 hp) - 12000 to 40000 rpm

Supplied with CNOMO collet, \varnothing 6mm



A



B



C



D



E

K3..-7 / KC3..-7 / KA3..E7 / KA3..-7 KA3.135-7
CNOMO type collet

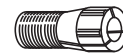

Caution: comply with the speeds recommended by component and abrasive manufacturers. PIC

PIC REF	MODEL	PART NUMBER	FREE SPEED		COLLET MAX CAPACITY		POWER		WEIGHT		AIR CONSUMPTION AT FREE SPEED		AIR CONSUMPTION AT MAX OUTPUT		AIR INLET. THREAD		HOSE INT. Ø	
			rpm		mm	in.	W	hp	kg	lb.	l/s	cfm	l/s	cfm	in.	mm	in.	
STRAIGHT GRINDERS																		
A	K340-7	615 170 036 0	40000		6.4	1/4	375	0.5	0.58	1.28	7.5	16.0	10.0	21	1/4	8	5/16	
A	K331-7	615 170 035 0	31000		6.4	1/4	375	0.5	0.58	1.28	4.5	9.5	9.5	20	1/4	8	5/16	
A	K325-7	615 170 034 0	25000		6.4	1/4	375	0.5	0.58	1.28	3.5	7.5	9.5	20	1/4	8	5/16	
A	K320-7	615 170 033 0	20000		6.4	1/4	375	0.5	0.58	1.28	2.5	5.0	8.0	17	1/4	8	5/16	
B	KC340-7	615 170 032 0	40000		6.4	1/4	375	0.5	0.40	0.88	7.5	16.0	10.0	21	1/4	8	5/16	
B	KC331-7	615 170 031 0	31000		6.4	1/4	375	0.5	0.40	0.88	4.5	9.5	9.5	20	1/4	8	5/16	
B	KC325-7	615 170 030 0	25000		6.4	1/4	375	0.5	0.40	0.88	3.5	7.5	9.5	20	1/4	8	5/16	
B	KC320-7	615 170 029 0	20000		6.4	1/4	375	0.5	0.40	0.88	2.5	5.0	8.0	17	1/4	8	5/16	
ANGLE GRINDERS																		
C	KA320E7	615 170 047 0	20000		6.4	1/4	375	0.5	0.60	1.32	6.5	13.5	10.0	21	1/4	8	5/16	
C	KA312E7	615 170 039 0	12000		6.4	1/4	375	0.5	0.60	1.32	3.0	6.5	9.0	19	1/4	8	5/16	
D	KA320-7	615 170 043 0	20000		6.4	1/4	375	0.5	0.50	1.10	6.5	13.5	10.0	21	1/4	8	5/16	
D	KA312-7	615 170 037 0	12000		6.4	1/4	375	0.5	0.50	1.10	3.0	6.5	9.0	19	1/4	8	5/16	
E	KA3.135-7	615 170 515 0	13500		8.0	5/16	300	0.4	0.60	1.30	9.5	20.0			1/4	6	1/4	

Accessories

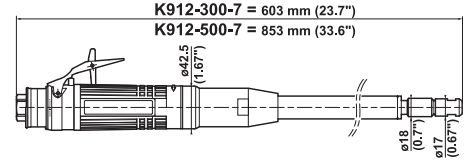
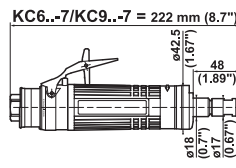
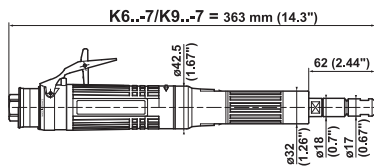

K6..-7 / K9..-7 / KC6..-7 / KC9..-7

ACCESSORIES INCLUDED

	PART NO.
• Collet-holder extension L = 28mm (1.1")	615 523 018 0
• CNOMO collet \varnothing 6mm	615 526 049 0
• Exhaust hose L = 1.5m (60")	615 875 113 0
• Clamp	615 873 415 0
• 3/8" air hose nipple for 10mm (3/8") ID hose	615 704 017 0
• Flat wrench, 14mm (Qty 2)	615 801 005 0

OPTIONAL ACCESSORIES

ITEM	PART NO.
• Collet-holder extension L = 28mm (1.1")	615 523 018 0
• CNOMO collet \varnothing 3mm	615 526 048 0
• CNOMO collet \varnothing 6.35mm (1/4")	615 526 050 0
• CNOMO collet \varnothing 8mm	615 526 051 0
1 Complete silencer kit	615 396 166 0
2 Clamp	615 873 115 0
3 Reinforced cloth-lined exhaust hose L = 0.75m (30")	615 875 116 0
4 Clippable silencer	615 396 655 0

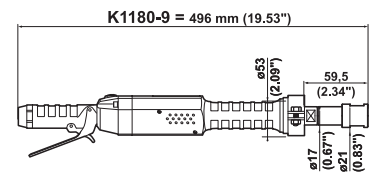
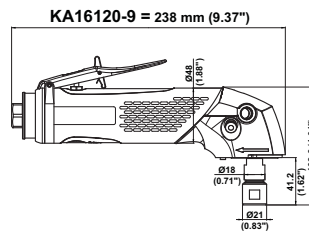
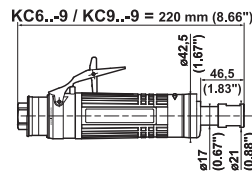
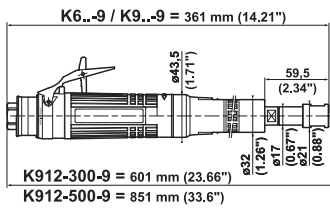
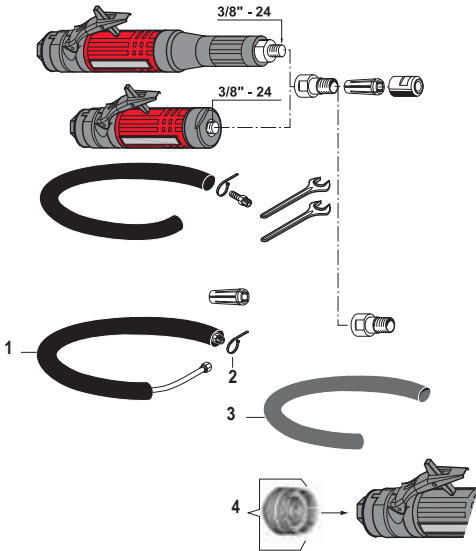

K6..-9 / K9..-9 / KC6..-9 / KC9..-9 / KA16120-9 / K1180-9

ACCESSORIES INCLUDED

	K/KC6 / K/KC9 KA16120-9	K1180-9
• Series 200 resilient collet, collet \varnothing 5.55 to 6.35mm (1/4")	615 526 063 0	615 526 063 0
• Series 200 resilient collet, collet \varnothing 8.7 to 9.5mm (3/8")		615 526 065 0
• Exhaust hose L = 1.5m (60")	615 875 113 0	
• Clamp	615 873 415 0	
• 3/8" air hose nipple for 10mm (3/8") ID hose	615 704 017 0	
• 3/8" air hose nipple for 13mm (1/2") ID hose for KA16120-9	615 704 027 0	
• 1/2" air hose nipple for 16mm (5/8") ID hose		615 704 014 0
• Flat wrench, 14mm	615 801 005 0	615 801 005 0
• Flat wrench, 19mm (3/4")	615 801 076 0	615 801 076 0
• Side handle for KA16120-9	615 576 038 0	

OPTIONAL ACCESSORIES

ITEM	K/KC6 / K/KC9 KA16120-9	K1180-9
• Series 200 resilient collet, collet \varnothing 2.4 to 3.2mm (1/8")	615 526 061 0	615 526 061 0
• Series 200 resilient collet, collet \varnothing 5.2 to 6mm	615 526 062 0	615 526 062 0
• Series 200 resilient collet, collet \varnothing 7.2 to 8mm	615 526 064 0	615 526 064 0
• Series 200 resilient collet, collet \varnothing 8.7 to 9.5mm (3/8")	615 526 065 0	
1 Vibration-damping handle for KA16120-9	615 576 066 0	
2 Complete silencer kit	615 396 166 0	
3 Clamp	615 873 115 0	
4 Reinforced cloth-lined exhaust hose L = 0.75m (30")	615 875 116 0	
5 Silencer kit		615 399 298 0
6 Silencer kit		615 399 459 0
7 Clippable silencer	615 396 655 0	
7 Clippable silencer for KA16120-9	615 396 957 0	
8 Grease gun (capacity 24g - 0.8oz) for KA16120-9	615 990 149 0	
• Grease for bevel gear (1kg - 2.2lb) for KA16120-9	615 990 148 0	

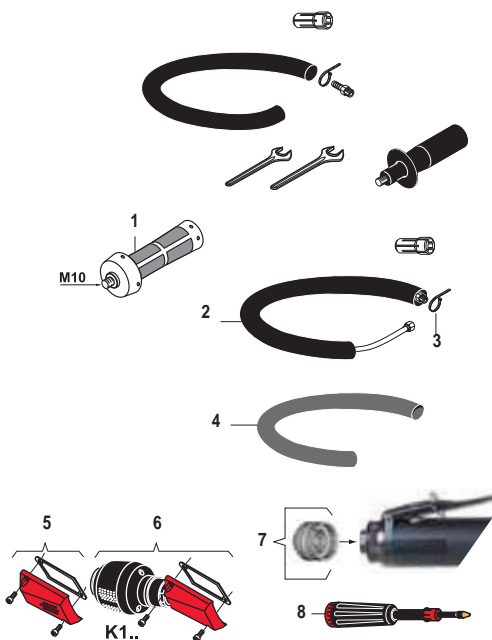

Grinders for carbide burrs and mounted points

600 to 1700 Watts (0.8 to 2.3 hp) - 12000 to 28000 rpm



Supplied with CNOMO collet, \varnothing 6mm

K6..-7 / K9..-7 / KC6..-7 / KC9..-7
CNOMO type collet



Supplied with series 200 resilient collet, \varnothing 5.55 to 6.35mm (1/4") & \varnothing 8.7 to 9.5mm (3/8")



K6..-9 / KC9..-9 / KC6..-9 /
KC9..-9 / KA1620-9 / K1180-9
Series 200 collet

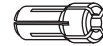

Caution: comply with the speeds recommended by component and abrasive manufacturers.

PIC REF	MODEL	PART NUMBER	FREE SPEED	COLLET MAX CAPACITY		POWER		WEIGHT		AIR CONSUMPTION AT FREE SPEED		AIR CONSUMPTION AT MAX OUTPUT		AIR INLET THREAD		HOSE INLET \varnothing	
				rpm	mm	in.	W	hp	kg	lb.	l/s	cfm	l/s	cfm	in.	mm	in.

CNOMO collet

A	K628-7	615 170 107 0	28000	8	5/16	600	0.80	1.3	2.9	16	34	15	32	3/8	10	3/8
A	K624-7	615 170 106 0	24000	8	5/16	600	0.80	1.3	2.9	10	21	15	32	3/8	10	3/8
A	K922-7	615 170 119 0	22000	8	5/16	900	1.21	1.4	3.1	13	28	18	38	3/8	10	3/8
A	K619-7	615 170 105 0	19000	8	5/16	600	0.80	1.3	2.9	6	13	15	32	3/8	10	3/8
A	K918-7	615 170 117 0	18000	8	5/16	900	1.21	1.4	3.1	10	21	18	38	3/8	10	3/8
A	K615-7	615 170 104 0	15000	8	5/16	600	0.80	1.3	2.9	6	13	15	32	3/8	10	3/8
A	K915-7	615 170 114 0	15000	8	5/16	900	1.21	1.4	3.1	8	17	17	36	3/8	10	3/8
A	K912-7	615 170 110 0	12000	8	5/16	900	1.21	1.4	3.1	6	13	16	34	3/8	10	3/8
B	KC628-7	615 170 126 0	28000	8	5/16	600	0.80	0.9	2.0	16	34	15	32	3/8	10	3/8
B	KC624-7	615 170 125 0	24000	8	5/16	600	0.80	0.9	2.0	10	21	15	32	3/8	10	3/8
B	KC922-7	615 170 130 0	22000	8	5/16	900	1.21	1.0	2.2	13	28	18	38	3/8	10	3/8
B	KC619-7	615 170 124 0	19000	8	5/16	600	0.80	0.9	2.0	6	13	15	32	3/8	10	3/8
B	KC918-7	615 170 129 0	18000	8	5/16	900	1.21	1.0	2.2	10	21	18	38	3/8	10	3/8
B	KC615-7	615 170 123 0	15000	8	5/16	600	0.80	0.9	2.0	6	13	15	32	3/8	10	3/8
B	KC915-7	615 170 128 0	15000	8	5/16	900	1.21	1.0	2.2	8	17	17	36	3/8	10	3/8
B	KC912-7	615 170 127 0	12000	8	5/16	900	1.21	1.0	2.2	6	13	16	34	3/8	10	3/8
C	K912-300-7	615 170 108 0	12000	8	5/16	900	1.21	2.1	4.6	6	13	16	34	3/8	10	3/8
C	K912-500-7	615 170 109 0	12000	8	5/16	900	1.21	2.7	5.9	6	13	16	34	3/8	10	3/8

SERIES 200 collet

D	K628-9	615 170 150 0	28000	9.5	3/8	600	0.80	1.3	2.9	16	34	15	32	3/8	10	3/8
D	K624-9	615 170 151 0	24000	9.5	3/8	600	0.80	1.3	2.9	10	21	15	32	3/8	10	3/8
D	K922-9	615 170 152 0	22000	9.5	3/8	900	1.21	1.4	3.1	13	28	18	38	3/8	10	3/8
D	K619-9	615 170 153 0	19000	9.5	3/8	600	0.80	1.3	2.9	6	13	15	32	3/8	10	3/8
D	K918-9	615 170 154 0	18000	9.5	3/8	900	1.21	1.4	3.1	10	21	18	38	3/8	10	3/8
D	K615-9	615 170 155 0	15000	9.5	3/8	600	0.80	1.3	2.9	6	13	15	32	3/8	10	3/8
D	K915-9	615 170 156 0	15000	9.5	3/8	900	1.21	1.4	3.1	8	17	17	36	3/8	10	3/8
D	K912-9	615 170 157 0	12000	9.5	3/8	900	1.21	1.4	3.1	6	13	16	34	3/8	10	3/8
E	KC628-9	615 170 158 0	28000	9.5	3/8	600	0.80	0.9	2.0	16	34	15	32	3/8	10	3/8
E	KC624-9	615 170 159 0	24000	9.5	3/8	600	0.80	0.9	2.0	10	21	15	32	3/8	10	3/8
E	KC922-9	615 170 160 0	22000	9.5	3/8	900	1.21	1.0	2.2	13	28	18	38	3/8	10	3/8
E	KC619-9	615 170 161 0	19000	9.5	3/8	600	0.80	0.9	2.0	6	13	15	32	3/8	10	3/8
E	KC918-9	615 170 162 0	18000	9.5	3/8	900	1.21	1.0	2.2	10	21	18	38	3/8	10	3/8
E	KC615-9	615 170 163 0	15000	9.5	3/8	600	0.80	0.9	2.0	6	13	15	32	3/8	10	3/8
E	KC915-9	615 170 164 0	15000	9.5	3/8	900	1.21	1.0	2.2	8	17	17	36	3/8	10	3/8
E	KC912-9	615 170 165 0	12000	9.5	3/8	900	1.21	1.0	2.2	6	13	16	34	3/8	10	3/8
F	K912-300-9	615 170 169 0	12000	9.5	3/8	900	1.21	2.1	4.6	6	13	16	34	3/8	10	3/8
F	K912-500-9	615 170 170 0	12000	9.5	3/8	900	1.21	2.7	5.9	6	13	16	34	3/8	10	3/8
G	KA16120-9	615 170 443 0	12000	9.5	3/8	1700	2.30	1.4	3.2	20	42	32	68	3/8	13	1/2
H	K1180-9	615 170 246 0	18000	9.5	3/8	1200	1.61	2.5	5.9	9	19	27	57	1/2	15	5/8

Accessories

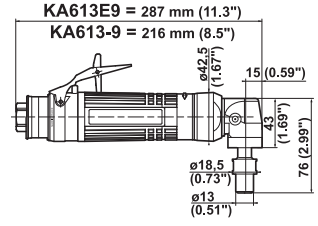
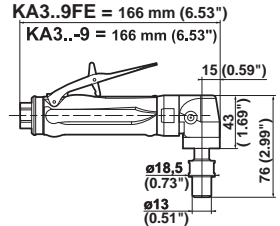
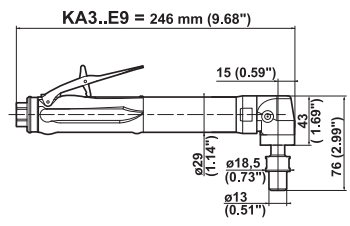
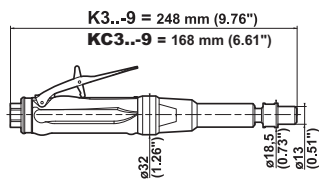

4734 / K3...-9 / KC3...-9 / KA3...E9 / KA3...-9 / KA3...-9FE

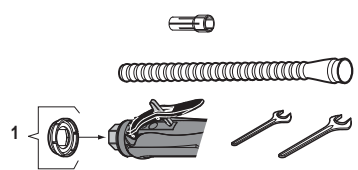

ACCESSORIES INCLUDED ITEM	4734	K3.../KC3...-9 KA3...E9/KA3...-9	KA3...-9FE
• Series 300 resilient collet, ϕ 5.55 to 6.35mm (1/4")	8482	615 526 059 0	615 526 059 0
• Exhaust hose L = 0.8m (31")	222453	615 875 106 0	
• Clamp	235203		
• 1/4" air hose nipple for 8mm (5/16") ID hose		615 704 019 0	615 704 019 0
1 Clippable silencer			615 396 124 0
• Flat wrench, 11mm (7/16")	199003	615 801 003 0	615 801 003 0
• Flat wrench, 17mm (1-1/16")	615 801 032 0	615 801 032 0	615 801 032 0
• Flat wrench, 16mm (5/8" A/F)	18583		

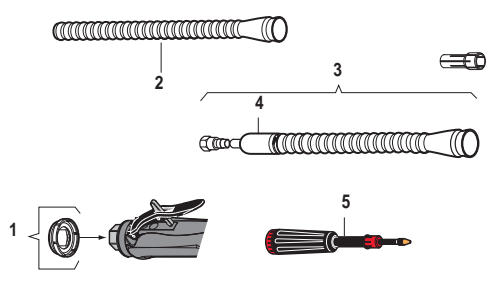

OPTIONAL ACCESSORIES ITEM	K3.../KC3...-9 KA3...E9/KA3...-9	KA3...-9FE
• Series 300 resilient collet, ϕ 0.4 to 1.2mm	615 526 052 0	615 526 052 0
• Series 300 resilient collet, ϕ 1.2 to 2mm	615 526 053 0	615 526 053 0
• Series 300 resilient collet, ϕ 1.7 to 2.5mm	615 526 054 0	615 526 054 0
• Series 300 resilient collet, ϕ 2.4 to 3.2mm (1/8")	615 526 055 0	615 526 055 0
• Series 300 resilient collet, ϕ 3.16 to 3.96mm	615 526 056 0	615 526 056 0
• Series 300 resilient collet, ϕ 3.95 to 4.75mm	615 526 057 0	615 526 057 0
• Series 300 resilient collet, ϕ 4.75 to 5.55mm	615 526 058 0	615 526 058 0
2 Exhaust hose L = 0.8 m (31")		615 875 106 0
3 Complete silencer kit	615 396 101 0	615 396 101 0
4 Silencer	615 574 028 0	615 574 028 0
1 Clippable silencer	615 396 124 0	
5 Grease gun (capacity 24g - 0.8 oz.)	615 990 149 0	615 990 149 0
• Grease for bevel gear (1kg - 2.2 lb.)	615 990 148 0	615 990 148 0

KA613E9 / KA613-9

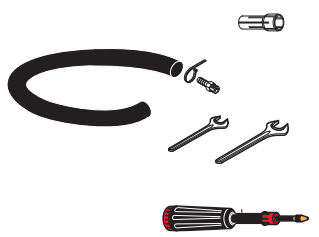

ACCESSORIES INCLUDED	PART NO.
• Series 300 resilient collet, ϕ 5.55 to 6.35mm (1/4")	615 526 059 0
• Exhaust hose L = 1.5m (60")	615 875 113 0
• Clamp	615 873 415 0
• 3/8" air hose nipple for 10mm (3/8") ID hose	615 704 017 0
• Flat wrench, 11mm (7/16")	615 801 003 0
• Flat wrench, 17mm (1-1/16")	615 801 032 0
• Grease gun (capacity 24g - 0.8 oz.)	615 990 149 0

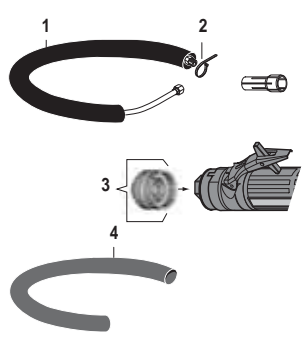

OPTIONAL ACCESSORIES ITEM	PART NO.
• Series 300 resilient collet, ϕ 0.4 to 1.2 mm (3/64")	615 526 052 0
• Series 300 resilient collet, ϕ 1.2 to 2 mm (5/64")	615 526 053 0
• Series 300 resilient collet, ϕ 1.7 to 2.5 mm (3/32")	615 526 054 0
• Series 300 resilient collet, ϕ 2.4 to 3.2 mm (1/8")	615 526 055 0
• Series 300 resilient collet, ϕ 3.16 to 3.96 mm (5/32")	615 526 056 0
• Series 300 resilient collet, ϕ 3.95 to 4.75 mm (3/16")	615 526 057 0
• Series 300 resilient collet, ϕ 4.75 to 5.55 mm (7/32")	615 526 058 0
1 Complete silencer kit	615 396 166 0
2 Clamp	615 873 115 0
3 Clippable silencer	615 396 655 0
4 Reinforced cloth-lined exhaust hose L = 0.75m (30")	615 875 116 0
• Grease for bevel gear (1 kg - 2.2 lb.)	615 990 148 0

Grinders for carbide burrs, mounted points and sanding discs

300 to 600 Watts (0.4 to 0.8 hp) - 9000 to 40000 rpm

Supplied with series 300 resilient collet, \varnothing 5.55 to 6.35mm (1/4")



Caution: comply with the speeds recommended by component and abrasive manufacturers.

PIC REF	MODEL	PART NUMBER	FREE SPEED	COLLET MAX CAPACITY		POWER		WEIGHT		AIR CONSUMPTION AT FREE SPEED		AIR CONSUMPTION AT MAX OUTPUT		AIR INLET. THREAD	HOSE INT. Ø	
			rpm	mm	in.	W	hp	kg	lb.	l/s	cfm	l/s	cfm	in.	mm	in.
STRAIGHT GRINDERS																
A	4734	4734	20000	6.35	1/4	300	0.4	0.60	1.32	8.5	18	10	21	1/4	10	3/8
B	K340-9	615 170 139 0	40000	6.35	1/4	375	0.5	0.57	1.26	7.5	16	10	21	1/4	8	5/16
B	K331-9	615 170 140 0	31000	6.35	1/4	375	0.5	0.57	1.26	4.5	9.5	9.5	20	1/4	8	5/16
B	K325-9	615 170 141 0	25000	6.35	1/4	375	0.5	0.57	1.26	3.5	7.5	9.5	20	1/4	8	5/16
B	K320-9	615 170 142 0	20000	6.35	1/4	375	0.5	0.57	1.26	2.5	5.0	8.0	17	1/4	8	5/16
C	KC340-9	615 170 143 0	40000	6.35	1/4	375	0.5	0.38	0.84	7.5	16	10	21	1/4	8	5/16
C	KC331-9	615 170 144 0	31000	6.35	1/4	375	0.5	0.38	0.84	4.5	9.5	9.5	20	1/4	8	5/16
C	KC325-9	615 170 145 0	25000	6.35	1/4	375	0.5	0.38	0.84	3.5	7.5	9.5	20	1/4	8	5/16
C	KC320-9	615 170 027 0	20000	6.35	1/4	375	0.5	0.38	0.84	2.5	5.0	8.0	17	1/4	8	5/16
C	KC318-9	615 170 196 0	18000	6.35	1/4	375	0.5	0.38	0.84	2.5	5.0	8.0	17	1/4	8	5/16
ANGLE GRINDERS																
D	KA320E9	615 170 146 0	20000	6.35	1/4	375	0.5	0.61	1.35	6.5	13.5	10	21	1/4	8	5/16
D	KA312E9	615 170 147 0	12000	6.35	1/4	375	0.5	0.61	1.35	3.0	6.5	9.0	9	1/4	8	5/16
E	KA320-9	615 170 148 0	20000	6.35	1/4	375	0.5	0.51	1.13	6.5	13.5	10	21	1/4	8	5/16
E	KA318-9	615 170 461 0	18000	6.35	1/4	375	0.5	0.51	1.13	6.5	13.5	10	21	1/4	8	5/16
E	KA312-9	615 170 149 0	12000	6.35	1/4	375	0.5	0.51	1.13	3.0	6.5	9.0	19	1/4	8	5/16
E	KA309-9	615 170 266 0	9000	6.35	1/4	375	0.5	0.50	1.10	3.0	6.5	9.0	19	1/4	8	5/16
F	KA320-9FE*	615 170 206 0	20000	6.35	1/4	375	0.5	0.51	1.13	6.5	13.5	10	21	1/4	8	5/16
F	KA312-9FE*	615 170 205 0	12000	6.35	1/4	375	0.5	0.51	1.13	3.0	6.5	9.0	19	1/4	8	5/16
G	KA613E9	615 170 136 0	13000	6.35	1/4	600	0.8	1.40	3.10	10	21	15	32	3/8	10	3/8
H	KA613-9	615 170 135 0	13000	6.35	1/4	600	0.8	1.10	2.40	10	21	15	32	3/8	10	3/8

* Front Exhaust models

Routers

375 to 900 Watts (0.5 to 1.21 hp) - 12000 to 40000 rpm

375 W (0.5hp) - 20000 to 40000 rpm

CNOMO type collet



A

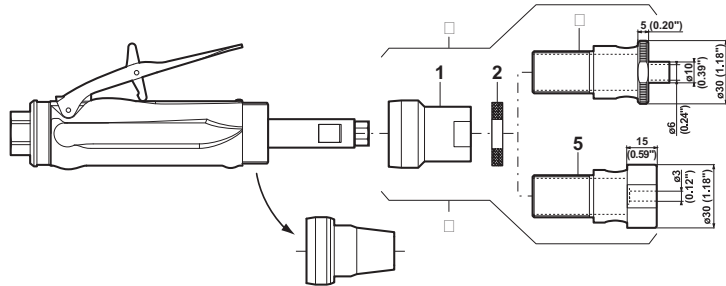

615 396 069 0: Machined routing kit for burr, max \varnothing 6.4mm (1/4")

615 396 070 0: Blank routing kit allowing you to adapt the blank to fit the application

600 - 900 W (0.8 - 1.21hp) - 12000 to 28000 rpm

CNOMO type or Series 200 collet



B

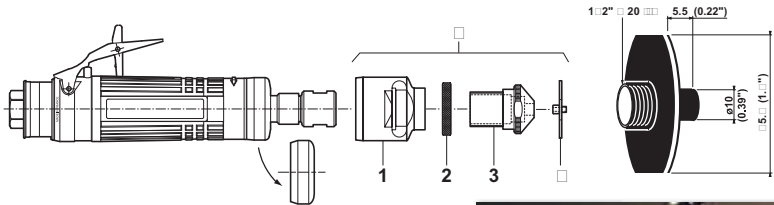

615 396 289 0: Machined routing kit for burr, max \varnothing 6.4mm (1/4")

OPTIONAL ACCESSORIES

ITEM	KC3..	KC6../KC9..
A Machined routing kit	615 396 069 0	615 396 289 0
B Blank routing kit (item 1, 2, 5)	615 396 070 0	
1 Flange	615 595 231 0	615 595 245 0
2 Adjusting nut	615 607 140 0	615 607 145 0
• Circlip		615 687 056 0
• Bearing		615 758 127 0
3 Router nose (including: circlips & bearing)		615 542 132 2
4 Machined routing guide	615 542 125 0	615 542 131 0
5 Blank routing guide	615 542 125 2	



If you need a complete tool use the KC624-9RT (24000 rpm) Part No. 615 170 290 0

If you need a specific speed or a higher power:

Select the motor, the speed of your choice below then add the routing kit.

For example: Tool with Series 200 collet - 900 W -22000 rpm (KC922-9) + routing kit **Order 615 170 160 0 + 615 396 289 0**

Caution: comply with the speeds recommended by component and abrasive manufacturers.

PIC REF	MODEL	FREE SPEED	POWER		PART NO.		ROUTING KIT	
			rpm	W	hp	CNOMO COLLET (-7)	SERIES 200 COLLET (-9)	MACHINED
375 Watts (0.5 hp) - CNOMO type collet								
A	KC340-7	40000	375	0.5	615 170 032 0		615 396 069 0	615 396 070 0
A	KC331-7	31000	375	0.5	615 170 031 0			
A	KC325-7	25000	375	0.5	615 170 030 0			
A	KC320-7	20000	375	0.5	615 170 029 0			
600 - 900 Watts (0.8 - 1.21 hp) - CNOMO type or Series 200 collet								
B	KC628-	28000	600	0.80	615 170 126 0	615 170 158 0	615 396 289 0	
B	KC624-	24000	600	0.80	615 170 125 0	615 170 159 0		
B	KC922-	22000	900	1.21	615 170 130 0	615 170 160 0		
B	KC619-	19000	600	0.80	615 170 124 0	615 170 161 0		
B	KC918-	18000	900	1.21	615 170 129 0	615 170 162 0		
B	KC615-	15000	600	0.80	615 170 123 0	615 170 163 0		
B	KC915-	15000	900	1.21	615 170 128 0	615 170 164 0		
B	KC912-	12000	900	1.21	615 170 127 0	615 170 165 0		

Collet Grinder Accessories

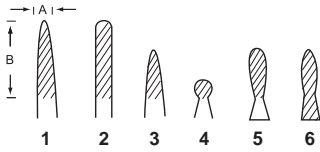

Tungsten Carbide Burrs are suitable for cutting unhardened and hardened steels, stainless, weld seams, steel castings, light and non-ferrous metals, plastics.

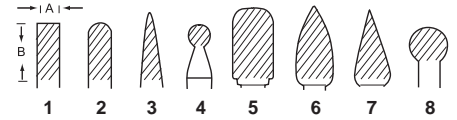

TUNGSTEN CARBIDE BURRS 3mm Ø SHANK

Can also be used with collet type CNOMO or 200 & 300 Series (1/8")

PIC REF	A		B		PART NO.
	mm	in.	mm	in.	
1	3	1/8	13	1/2	38122
2	3	1/8	13	1/2	38132
3	3	1/8	8	5/16	38142
4	3	1/8	3	1/8	38152
5	3	1/8	8	5/16	38162
6	3	1/8	8	5/16	38172

TUNGSTEN CARBIDE BURRS 6mm Ø SHANK

Can also be used with collet type CNOMO or 200 & 300 Series (1/4")

PIC REF	A		B		PART NO.
	mm	in.	mm	in.	
1	6	1/4	13	1/2	38182
2	6	1/4	16	5/8	38192
3	6	1/4	19	3/4	38202
4	6	1/4	6	1/4	38222
5	10	3/8	19	3/4	36122
6	10	3/8	19	3/4	36132
7	10	3/8	19	3/4	36142
8	10	3/8	10	3/8	38232

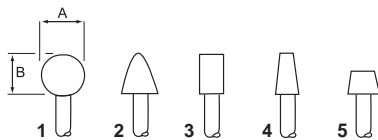

Aluminium Oxide Mounted Points are available in red grades. Red grades are suitable for grinding high tensile materials such as ordinary and alloy steels, high speed steel and annealed malleable iron.

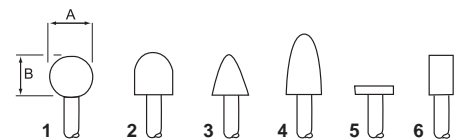

MOUNTED POINTS 3mm Ø SHANK - RED

Can also be used with collet type CNOMO or 200 & 300 Series (1/8")

PIC REF	MAX SPEED	A		B		PART NO.
		mm	in.	mm	in.	
1	104000	5	0.19	5	0.19	38582
2	104000	5	0.19	8	0.31	38522
3	81000	6	0.25	6	0.25	38632
4	105000	4	0.16	4	0.16	38562
5	81000	6	0.25	6	0.25	38542

MOUNTED POINTS 6mm Ø SHANK - RED

Can also be used with collet type CNOMO or 200 & 300 Series (1/4")

PIC REF	MAX SPEED	A		B		PART NO.
		mm	in.	mm	in.	
1	59000	16	0.62	16	0.62	435983
2	50000	20	0.79	16	0.62	435993
3	45000	20	0.79	28	1.10	436003
4	48000	20	0.79	32	1.26	436013
5	53000	20	0.79	22	0.87	436023
6	40000	13	0.51	25	1.00	436033
6	38000	25	1.00	3	0.11	436043

RECOMMENDED SPEEDS FOR TUNGSTEN CARBIDE BURRS - rpm x 1000

MATERIAL	HEAD DIAMETER				
	3mm (1/8")	6mm (1/4")	10mm (3/8")	13mm (1/2")	16mm (5/8")
Alum, Zinc Base, Plastics	30-90	15-70	10-50	17-38	6-30
Cast Iron, Brass, Copper, Bronze	45-90	23-60	15-40	11-30	9-24
Mild Steel	60-90	45-60	30-40	22-30	18-24
Titanium, Stainless, Hardened Steels, Ceramics	60-90	30-45	19-30	15-22	12-18

BACKING PAD WITH 6mm Ø SHANK



SPEED	Ø		PART NO.
rpm	mm	in.	
25000	50	1.97	615 804 098 0



ABRASIVE DISCS

SPEED	GRIT	PART NO.
rpm		
25000	P40	615 804 099 0
25000	P60	615 804 100 0
25000	P80	615 804 101 0
25000	P120	615 804 102 0

Accessories

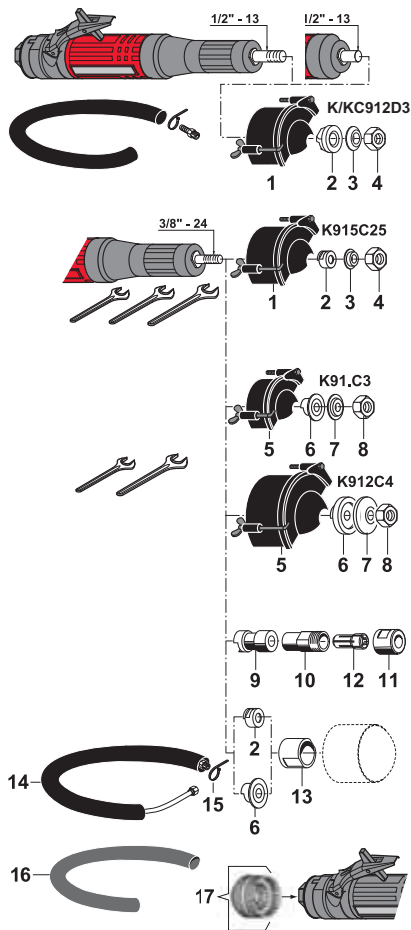
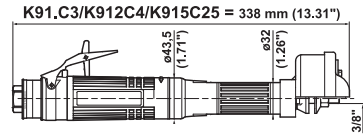
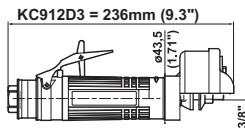
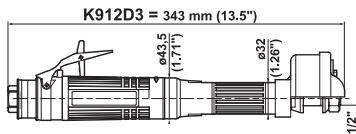

K9..

ACCESSORIES INCLUDED

ITEM	K/KC912D3 ø 80mm (3")	K915C25 ø 63mm (2 1/2")
• Exhaust hose L = 1.5m (60")	615 875 113 0	615 875 113 0
• Clamp	615 873 415 0	615 873 415 0
• 3/8" air hose nipple for 10mm ID hose	615 704 017 0	615 704 017 0
1 Wheel guard for K912D3	615 504 151 0	615 504 150 0
1 Wheel guard for KC912D3	615 504 214 0	
2 Rear flange	615 503 127 0	615 503 126 0
3 Front flange	615 502 044 0	615 502 043 0
4 Locknut	615 608 045 0	615 608 044 0
• Flat wrench 17mm (1-1/16")		615 801 032 0
• Flat wrench 14.3mm (9/16")		615 801 074 0
• Flat wrench 19mm (3/4")	615 801 076 0	

ITEM	K91.C3 ø 80mm (3")	K912C4 ø 100mm (4")
5 Wheel guard	615 504 151 0	615 504 152 0
6 Rear flange	615 503 125 0	615 503 131 0
7 Front flange	615 502 013 0	615 502 063 0
8 Locknut	615 608 044 0	615 608 044 0
• Flat wrench. 14.3mm (9/16")	615 801 074 0	615 801 074 0
• Flat wrench. 19mm (3/4")	615 801 076 0	615 801 076 0

OPTIONAL ACCESSORIES

ITEM	PART NO.
9 Spacer for collet-holder	615 666 149 0
10 Series 200 collet-holder	615 523 023 0
11 Series 200 collet nut	615 607 144 0
12 Series 200 Erickson collet	(see page 200)
13 Spacer for threaded cone wheel 3/8"	615 503 516 0
• Rear flange supplied with tool 615 503 125 0 or 615 503 126 0	
14 Complete silencer kit	615 396 166 0
15 Clamp	615 873 115 0
16 Reinforced cloth-lined exhaust hose L = 0.75 m (30")	615 875 116 0
17 Clippable silencer	615 396 655 0



Grinders for cone wheels and type 1 wheels

∅ 63mm (2-1/2'') - ∅ 80mm (3'') - ∅ 100mm (4'')
 900 Watts (1.21 hp) - 12000 to 18000 rpm



A



B



C



D



E

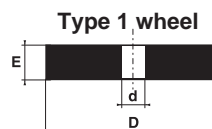

Type 1 wheel

Wheel type 16 - 18 - 18R and 19



* Reinforced resinoid wheel

Caution: comply with the speeds recommended by component and abrasive manufacturers.

PIC REF	MODEL	PART NUMBER	FREE SPEED	WHEEL MAX CAPACITY DxD		THREADED SPINDLE	POWER		WEIGHT		AIR CONSUMPTION AT FREE SPEED		AIR CONSUMPTION AT MAX OUTPUT		AIR INLET THREAD	HOSE INT. Ø	
			rpm	mm	in.	in.	W	hp	kg	lb.	l/s	cfm	l/s	cfm	in.	mm	in
A	K918C3	615 170 118 0	18000	*80 x13x9.52	3x1/2x3/8	3/8-24	900	1.21	1.7	3.7	7	15	16	34	3/8	10	3/8
A	K915C3	615 170 116 0	15000	*80 x13x9.52	3x1/2x3/8	3/8-24	900	1.21	1.7	3.7	7	15	16	34	3/8	10	3/8
A	K912C3	615 170 111 0	12000	*80 x13x9.52	3x1/2x3/8	3/8-24	900	1.21	1.7	3.7	7	15	16	34	3/8	10	3/8
B	K915C25	615 170 115 0	15000	63 x13x9.52	2-1/2x1/2x3/8	3/8-24	900	1.21	1.6	3.5	7	15	16	34	3/8	10	3/8
C	K912D3	615 170 113 0	12000	80 x20x12.7	3x25/32x1/2	1/2-13	900	1.21	1.7	3.7	7	15	16	34	3/8	10	3/8
D	KC912D3	615 170 491 0	12000	80 x20x12.7	3x25/32x1/2	1/2-13	900	1.21	1.3	2.9	7	15	16	34	3/8	10	3/8
E	K912C4	615 170 112 0	12000	*100 x13x9.52	4x1/2x3/8	3/8-24	900	1.21	1.8	4.0	7	15	16	34	3/8	10	3/8

3/8"-24 UNF - 1/2"-13 UNC

Accessories

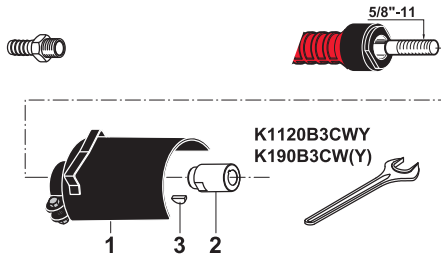
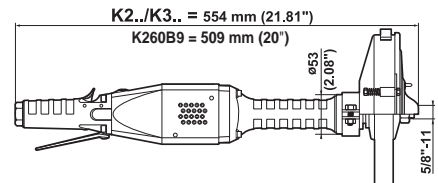
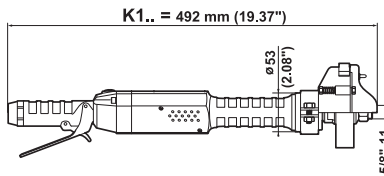
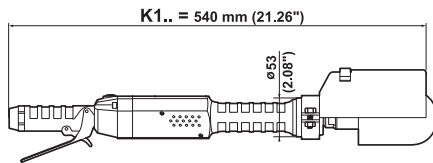

K1120B3CWY / K190B3CW(CWY) - \varnothing 80mm (3")

ACCESSORIES INCLUDED

ITEM	PART NO.
• 1/2" air hose nipple for 16mm (5/8") ID hose	615 704 014 0
1 Wheel guard	615 504 080 0
2 Rear flange	615 503 095 0
3 Woodruff key	615 630 019 0
• Flat wrench, 27mm (1-1/16")	615 801 077 0

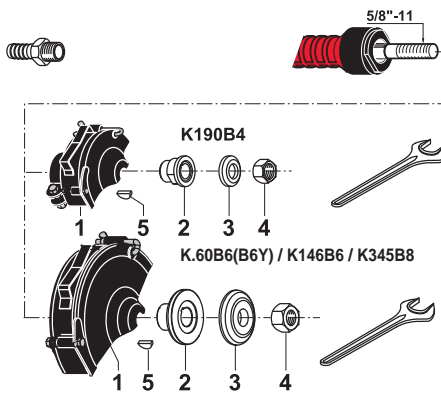

K190B4 / K.60B6(B6Y) / K145B6 / K345B8

ACCESSORIES INCLUDED

ITEM	K190B4 \varnothing 100mm (4")	K.60B6 (B6Y) K145B6 \varnothing 150mm (6")	K345B8 \varnothing 200 mm (8")
	• 1/2" air hose nipple for 16mm (5/8") ID hose	615 704 014 0	615 704 014 0
1 Wheel guard	615 504 154 0	615 504 079 0	615 504 078 0
2 Rear flange	615 503 094 0	615 503 028 0	615 503 004 0
3 Front flange	615 502 046 0	615 502 027 0	615 502 007 0
4 Nut	615 608 006 0	615 608 006 0	615 608 006 0
5 Woodruff key	615 630 019 0	615 630 019 0	615 630 019 0
• Flat wrench, 27mm (1-1/16")	615 801 077 0	615 801 077 0	615 801 077 0

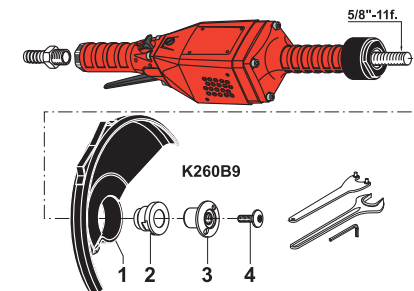

K260B9 - \varnothing 230 mm (9")

ACCESSORIES INCLUDED

ITEM	PART NO.
• 1/2" air hose nipple for 16mm (5/8") ID hose	615 704 014 0
1 Wheel guard	615 504 161 0
2 Rear flange	615 503 103 0
3 Nut	615 542 104 0
4 Safety screw	615 614 034 0
• Pin wrench, 35mm (1-3/8")	615 802 010 0
• Flat wrench, 27mm (1-1/16")	615 801 077 0
• Hex. key 6 mm	615 802 056 0

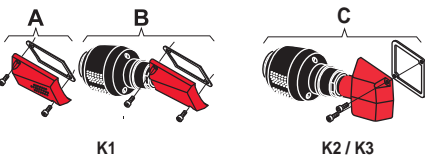

OPTIONAL ACCESSORIES

ITEM	K1..	K2.. / K3..
A Silencer kit	615 399 298 0	
B Silencer kit	615 399 459 0	
C Silencer kit		615 399 460 0



Grinders for cone wheels and type 1 wheels

∅ 80mm (3") - ∅ 100mm (4") - ∅ 150mm (6") - ∅ 200mm (8") - ∅ 230mm (9")
 1000 to 2700 Watts (1.34 to 3.62 hp) - 4500 to 12000 rpm



A



B



C



D



E



F

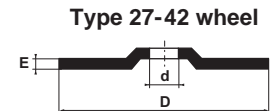

Wheel. type 16 - 18 - 18R and 19

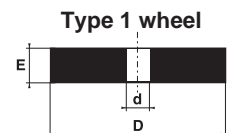

Caution: comply with the speeds recommended by component and abrasive manufacturers.

PIC REF	MODEL	PART NUMBER	FREE SPEED	WHEEL MAX CAPACITY DxExd		THREADED SPINDLE	POWER		WEIGHT		AIR CONSUMPTION AT FREE SPEED		AIR CONSUMPTION AT MAX OUTPUT		AIR INLET THREAD		HOSE INT. Ø	
			rpm	mm	in.	in.	W	hp	kg	lb.	l/s	cfm	l/s	cfm	in.	mm	in.	
A	K190B3CW	615 170 005 0	9000	80	3	5/8-11	1200	1.61	3.5	7.7	9	19	27	57	1/2	15	5/8	
B	K190B4	615 170 004 0	9000	100x25x15.9	4x1x5/8	5/8-11	1200	1.61	3.2	7.0	9	19	27	57	1/2	15	5/8	
C	K160B6	615 170 003 0	6000	150x25x15.9	6x1x5/8	5/8-11	1200	1.61	3.5	7.7	6	12	23	48	1/2	15	5/8	
C	K145B6	615 170 002 0	4500	150x25x15.9	6x1x5/8	5/8-11	1000	1.34	3.5	7.7	5	10	20	42	1/2	15	5/8	
D	K360B6	615 170 010 0	6000	150x25x15.9	6x1x5/8	5/8-11	2700	3.62	5.6	12.3	13	27	41	86	1/2	15	5/8	
E	K345B8	615 170 009 0	4500	200x25x15.9	8x1x5/8	5/8-11	2400	3.22	6.3	13.9	8	17	33	70	1/2	15	5/8	
F	K260B9	615 170 007 0	6000	230x6.4x22.2	9x1/4x7/8	5/8-11	2200	2.95	5.0	11.0	10	21	38	80	1/2	15	5/8	

For USA Market only (to ANSI B186.1)

A	K1120B3CWY	615 170 171 0	12000	80	3	5/8-11	1300	1.74	3.0	6.6	16	34	30	64	1/2	15	5/8
A	K190B3CWY	615 170 172 0	9000	80	3	5/8-11	1200	1.61	3.0	6.6	9	19	27	57	1/2	15	5/8
C	K160B6Y	615 170 173 0	6000	150x25x15.9	6x1x5/8	5/8-11	1200	1.61	3.5	7.7	6	12	23	48	1/2	15	5/8

5/8"-11 UNC

Accessories

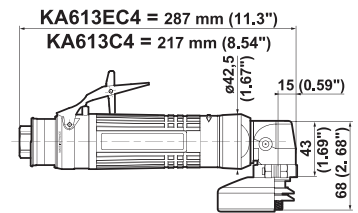
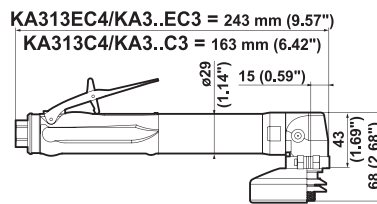
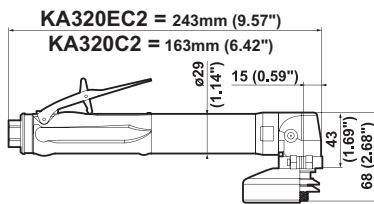

KA320EC2/C2 / KA3..EC3/C3 / KA313EC4/C4C

ACCESSORIES INCLUDED

ITEM	KA3..EC2 KA320C2 51mm (2")	KA3..EC3 KA3..C3 ø 76mm (3")	KA313EC4 KA313C4 ø 100mm (4")
• Exhaust hose L = 0.8m (31")	615 875 106 0	615 875 106 0	615 875 106 0
• 1/4" air hose nipple for 8mm ID hose	615 704 019 0	615 704 019 0	615 704 019 0
1 Wheel guard	615 504 207 0	615 504 155 0	615 504 160 0
2 Flange			615 606 515 0
3 Flange		615 502 064 0	615 502 064 0
4 Flange		615 503 144 0	615 503 144 0
5 Flange	615 502 082 0		
6 Nut	894 016 276 5		
• Pin wrench, 20-3mm		615 802 008 0	615 802 008 0
• Pin wrench	615 802 008 0		
• Flat wrench, 11mm (7/16")	615 801 003 0	615 801 003 0	615 801 003 0

OPTIONAL ACCESSORIES

ITEM	PART NO.
7 Complete silencer kit	615 396 101 0
8 Silencer	615 574 028 0
9 Clippable silencer	615 396 124 0
10 Grease gun includes (24g - 0.8oz)	615 990 149 0
• Grease for bevel gear (1kg - 2.2lb)	615 990 148 0

KA613EC4 / KA613C4 - ø 100mm (4")

ACCESSORIES INCLUDED

ITEM	KA613EC4 KA613C4
• Exhaust hose L = 1.5m (60")	615 875 113 0
• Clamp	615 873 415 0
• 3/8" air hose nipple for 10mm ID hose	615 704 017 0
1 Wheel guard	615 504 160 0
2 Flange	615 606 515 0
3 Flange	615 502 064 0
4 Flange	615 503 144 0
5 Grease gun includes (24g - 0.8oz)	615 990 149 0
• Pin wrench, 20-3mm	615 802 008 0
• Flat wrench, 11mm (7/16")	615 801 003 0

OPTIONAL ACCESSORIES

ITEM	PART NO.
6 Complete silencer kit	615 396 166 0
7 Clamp	615 873 115 0
8 Reinforced cloth-lined exhaust hose L = 0.75m (30")	615 875 116 0
9 Clippable silencer	615 396 655 0
• Grease for bevel gear (1kg - 2.2lb)	615 990 148 0

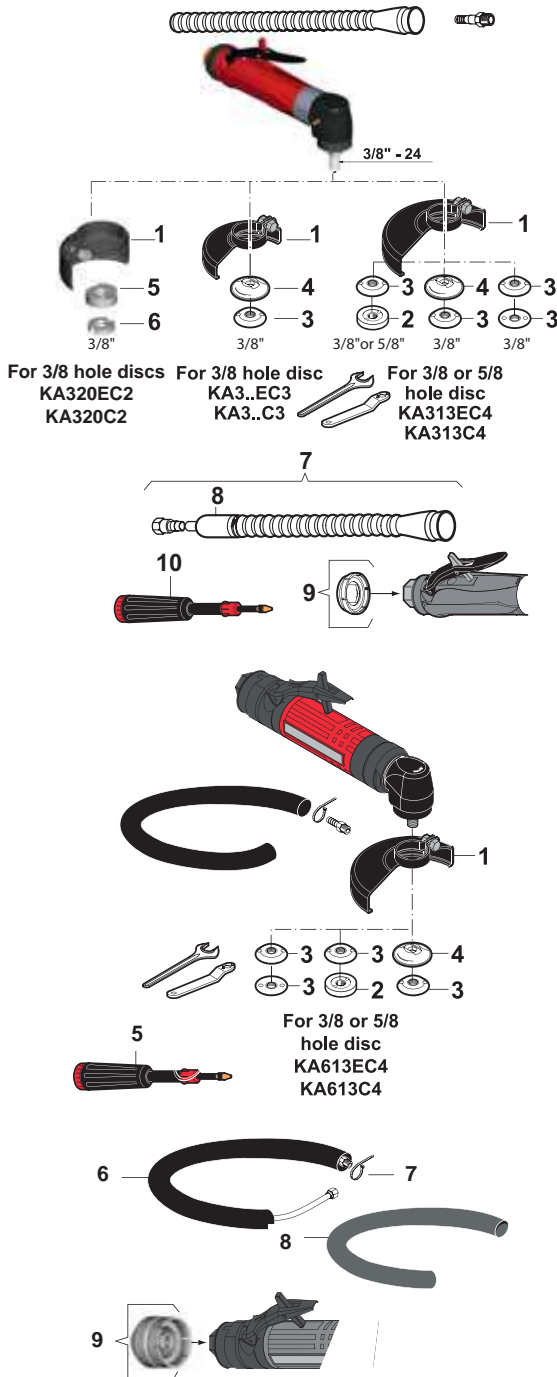

Grinders for depressed center wheels and cut-off wheels

Ø 51mm (2") - Ø 76mm (3") - Ø 100mm (4")
375 and 600 Watts (0.5 and 0.8 hp) - 13000 to 20000 rpm

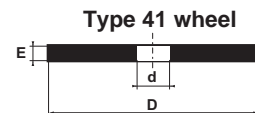
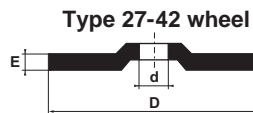

Caution: comply with the speeds recommended by component and abrasive manufacturers

PIC REF	MODEL	PART NUMBER	FREE SPEED	WHEEL MAX CAPACITY D x Exd		THREADED SPINDLE	POWER		WEIGHT		AIR CONSUMPTION AT FREE SPEED		AIR CONSUMPTION AT MAX OUTPUT		AIR INLET THREAD	HOSE INT. Ø	
			rpm	mm	in.		W	hp	kg	lb.	l/s	cfm	l/s	cfm		in.	mm
A	KA320EC2	615 170 487 0	20000	51 x7x9.52	2x1/4x3/8	3/8-24	375	0.5	0.81	1.78	6.5	13.5	10.0	21	1/4	8	5/16
B	KA320EC3	615 170 046 0	20000	76 x7x9.52	3x1/4x3/8	3/8-24	375	0.5	0.81	1.78	6.5	13.5	10.0	21	1/4	8	5/16
B	KA318EC3	615 170 045 0	18000	76 x7x9.52	3x1/4x3/8	3/8-24	375	0.5	0.81	1.78	4.5	9.5	9.5	20	1/4	8	5/16
C	KA313EC4	615 170 050 0	13000	100 x7x9.52 & 15.9	4x1/4x3/8&5/8	3/8-24	375	0.5	0.83	1.83	3.0	6.5	9.0	19	1/4	8	5/16
D	KA320C2	615 170 488 0	20000	51 x7x9.52	2x1/4x3/8	3/8-24	375	0.5	0.64	1.41	6.5	13.5	10.0	21	1/4	8	5/16
E	KA320C3	615 170 042 0	20000	76 x7x9.52	3x1/4x3/8	3/8-24	375	0.5	0.64	1.41	6.5	13.5	10.0	21	1/4	8	5/16
E	KA318C3	615 170 041 0	18000	76 x7x9.52	3x1/4x3/8	3/8-24	375	0.5	0.64	1.41	4.5	9.5	9.5	20	1/4	8	5/16
F	KA313C4	615 170 049 0	13000	100 x7x9.52 & 15.9	4x1/4x3/8&5/8	3/8-24	375	0.5	0.66	1.45	3.0	6.5	9.0	19	1/4	8	5/16
G	KA613EC4	615 170 138 0	13000	100 x7x9.52 & 15.9	4x1/4x3/8&5/8	3/8-24	600	0.8	1.50	3.30	10.0	21.0	15.0	32	3/8	10	3/8
H	KA613C4	615 170 137 0	13000	100 x7x9.52 & 15.9	4x1/4x3/8&5/8	3/8-24	600	0.8	1.20	2.60	10.0	21.0	15.0	32	3/8	10	3/8

3/8"-24 UNF

Accessories

KA16135C4FK = 238mm (9.37")

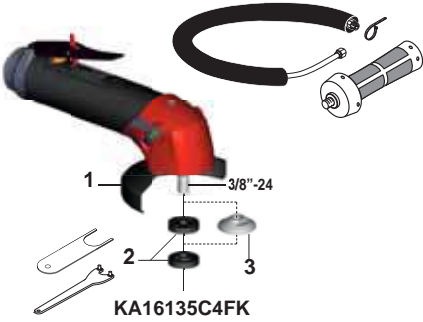
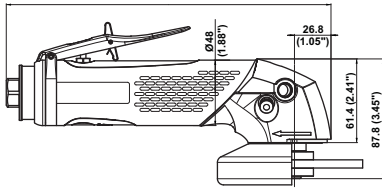

KA16120A45VK / B45VK = 238mm (9.37")

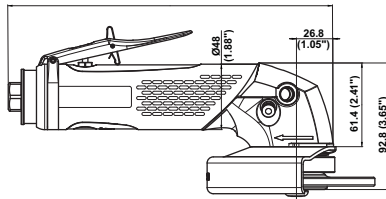

KA16120A45 / B45 = 238mm (9.37")

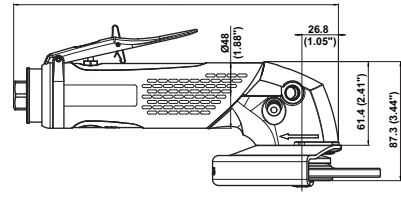

KA16135C4FK - ø 100mm (4")

ACCESSORIES INCLUDED

ITEM	KA16135C4FK 3/8"-24
• Complete silencer kit	615 396 166 0
• Clamp	615 263 024 0
• Vibration-damping side handle	615 576 066 0
• Case	615 995 107 0
1 Wheel guard	615 504 196 0
2 Flange (Qty 2)	615 606 515 0
3 Rear flange	615 503 515 0
• Pin wrench 20-3mm	615 802 008 0
• Flat wrench, 16mm (5/8")	615 802 512 0

OPTIONAL ACCESSORIES

ITEM	PART NO.
4 Clippable silencer	615 396 957 0
5 Grease gun includes 24g (0.8oz)	615 990 149 0
• Grease for bevel gear (1 kg - 2.2 lb)	615 990 148 0

KA16120A45VK - KA16120B45VK - ø 115mm (4.5")

ACCESSORIES INCLUDED

ITEM	KA16120A45VK M14x2	KA16120B45VK 5/8"-11
• Complete silencer kit	615 396 166 0	615 396 166 0
• Clamp	615 263 024 0	615 263 024 0
• Vibration-damping side handle	615 576 066 0	615 576 066 0
• Case	615 995 107 0	615 995 107 0
1 Multi-position guard	615 504 195 0	615 504 195 0
2 Auto-balancer	615 990 181 0	615 990 181 0
3 Front flange	615 502 066 0	615 502 067 0
4 Safety screw	615 614 076 0	615 614 076 0
• Pin wrench, 35mm (1-3/8")	615 802 010 0	615 802 010 0
• Hex. key 6.35mm (1/4")	615 802 057 0	615 802 057 0

KA16120A45 - KA16120B45 - ø 115mm (4.5")

ACCESSORIES INCLUDED

ITEM	KA16120A45 M14x2	KA16120B45 5/8"-11
• Exhaust hose L = 1.5m (60")	615 875 113 0	615 875 113 0
• Clamp	615 263 024 0	615 263 024 0
• 3/8" air hose nipple for 13mm (1/2") ID hose	615 704 027 0	615 704 027 0
• Side handle	615 576 038 0	615 576 038 0
1 Multi-position guard	615 504 198 0	615 504 198 0
2 Rear flange	615 503 134 0	615 503 141 0
3 Front flange	615 502 066 0	615 502 067 0
4 Safety screw	615 614 076 0	615 614 076 0
• Pin wrench, 35mm (1-3/8")	615 802 010 0	615 802 010 0
• Hex. key 6.35mm (1/4")	615 802 057 0	615 802 057 0

OPTIONAL ACCESSORIES

ITEM	PART NO.
5 Complete silencer kit	615 396 166 0
6 Clamp	615 263 024 0
7 Reinforced cloth-lined exhaust hose L= 0.75m (30")	615 875 116 0
8 Vibration-damping side handle	615 576 066 0
9 Clippable silencer	615 396 957 0
10 Grease gun includes 24g (0.8oz)	615 990 149 0
• Grease for bevel gear (1 kg - 2.2lb)	615 990 148 0

Grinders for depressed center wheels, cut-off wheels and flap wheels

Ø 100mm (4") - Ø 115mm (4.5")
1700 Watts (2.3 hp) - 12000 and 13500 rpm

Fixed wheel guard

Multi-position guard



A



B



C



Type 27-42 wheel

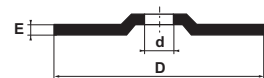

Type 41 wheel



Depressed centre flap wheels

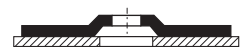

FLAT

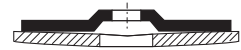

CURVED

Caution: comply with the speeds recommended by component and abrasive manufacturers.

PIC REF	MODEL	PART NUMBER	FREE SPEED	WHEEL MAX CAPACITY		THREADED SPINDLE	POWER	WEIGHT		AIR CONSUMPTION				AIR INLET THREAD		HOSE INT. Ø	
				mm	in.			W	hp	kg	lb.	l/s	cfm	l/s	cfm	in.	mm
FIXED WHEEL GUARD																	
A	KA16135C4FK	615 170 441 0	13500	100x6.4x16	4x1/4x5/8	3/8-24	1700 2.3	1.53 3.4	25 53	35 74	3/8	13	1/2				
MULTI-POSITION GUARD																	
B	KA16120A45VK	615 170 456 0	12000	115x6.4x22.2	4.5x1/4x7/8	M14x2	1700 2.3	1.87 4.1	20 42	32 68	3/8	13	1/2				
B	KA16120B45VK	615 170 458 0	12000	115x6.4x22.2	4.5x1/4x7/8	5/8-11	1700 2.3	1.87 4.1	20 42	32 68	3/8	13	1/2				
C	KA16120A45	615 170 455 0	12000	115x6.4x22.2	4.5x1/4x7/8	M14x2	1700 2.3	1.75 3.9	20 42	32 68	3/8	13	1/2				
C	KA16120B45	615 170 457 0	12000	115x6.4x22.2	4.5x1/4x7/8	5/8-11	1700 2.3	1.75 3.9	20 42	32 68	3/8	13	1/2				

5/8"-11 UNC

Accessories

KA16120A5VK / B5VK = 238mm (9.37")

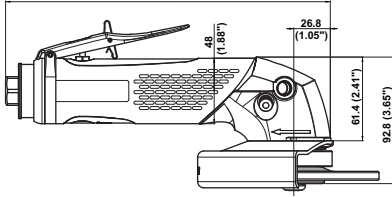

KA16120H5K / H5 = 238mm (9.37")

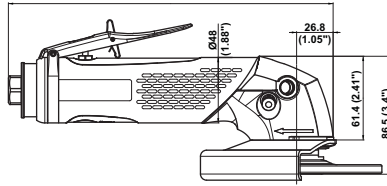

KA16120A5 / B5 = 238mm (9.37")

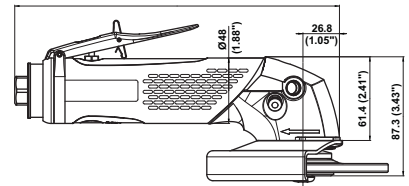

KA16120A5VK / B5VK / H5K - ø 127mm (5")

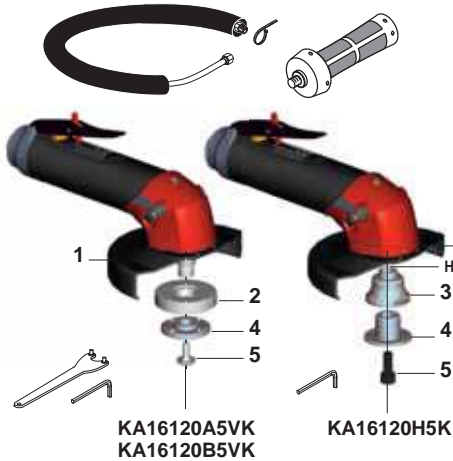

ACCESSORIES INCLUDED	KA16120A5VK M14x2	KA16120B5VK 5/8"-11	KA16120H5K Hex.
• Complete silencer kit	615 396 166 0	615 396 166 0	615 396 166 0
• Clamp	615 263 024 0	615 263 024 0	615 263 024 0
• Vibration-damping side handle	615 576 066 0	615 576 066 0	615 576 066 0
• Case	615 995 107 0	615 995 107 0	615 995 107 0
1 Multi-position guard	615 504 193 0	615 504 193 0	615 504 197 0
2 Auto-balancer	615 990 181 0	615 990 181 0	
3 Rear flange			615 503 124 0
4 Front flange	615 502 066 0	615 502 067 0	615 502 062 0
5 Safety screw	615 614 076 0	615 614 076 0	615 616 101 0
• Pin wrench, 35mm (1-3/8")	615 802 010 0	615 802 010 0	
• Hex. key 6mm			615 802 056 0
• Hex. key 6.35mm (1/4")	615 802 057 0	615 802 057 0	

KA16120A5 / B5 / H5 - ø 127mm (5")

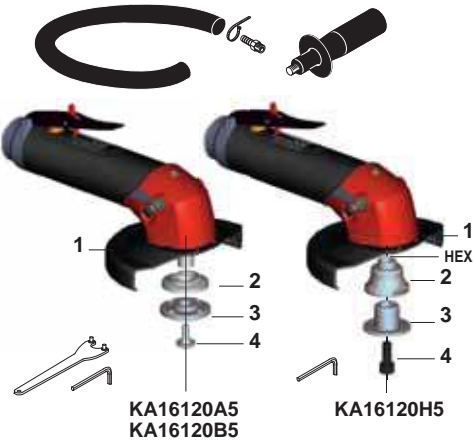

ACCESSORIES INCLUDED	KA16120A5 M14x2	KA16120B5 5/8"-11	KA16120H5 Hex.
• Exhaust hose L = 1.5m (60")	615 875 113 0	615 875 113 0	615 875 113 0
• Clamp	615 263 024 0	615 263 024 0	615 263 024 0
• 3/8" air hose nipple for 13mm (1/2") ID hose	615 704 027 0	615 704 027 0	615 704 027 0
• Side handle	615 576 038 0	615 576 038 0	615 576 038 0
1 Multi-position guard	615 504 197 0	615 504 197 0	615 504 197 0
2 Rear flange	615 503 134 0	615 503 141 0	615 503 124 0
3 Front flange	615 502 066 0	615 502 067 0	615 502 062 0
4 Safety screw	615 614 076 0	615 614 076 0	615 616 101 0
• Pin wrench, 35mm (1-3/8")	615 802 010 0	615 802 010 0	
• Hex. key 6mm			615 802 056 0
• Hex. key 6.35mm (1/4")	615 802 057 0	615 802 057 0	

OPTIONAL ACCESSORIES

ITEM	PART NO.
5 Complete silencer kit	615 396 166 0
6 Clamp	615 263 024 0
7 Reinforced cloth-lined exhaust hose L = 0.75 m (30")	615 875 116 0
8 Vibration-damping side handle	615 576 066 0
9 Clippable silencer	615 396 957 0
10 Grease gun includes 24g (0.8oz)	615 990 149 0
• Grease for bevel gear (1kg - 2.2lb)	615 990 148 0

OTHER OPTIONAL ACCESSORIES

For cutting or milling application in aluminium

ITEM	KA16120A5
11 Guard ø 127mm	615 811 148 0
12 Cutter, teeth thickness 2mm	615 811 146 0
12 Cutter, teeth thickness 4mm	615 811 147 0



Grinders for depressed center wheels, cut-off wheels and flap wheels

Ø 127mm (5")

1700 Watts (2.3 hp) - 12000 rpm

Quick wheel change

Multi-position guard



Type 27-42 wheel



Type 41 wheel

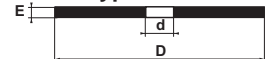

Depressed centre flap wheels

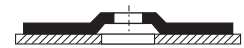

FLAT



CURVED

Caution: comply with the speeds recommended by component and abrasive manufacturers.

PIC REF	MODEL	PART NUMBER	FREE SPEED	WHEEL MAX CAPACITY DxExd		THREADED SPINDLE	POWER		WEIGHT		AIR CONSUMPTION AT FREE SPEED		AIR CONSUMPTION AT MAX OUTPUT		AIR INLET THREAD	HOSE INT. Ø	
			rpm	mm	in.	in.	W	hp	kg	lb.	l/s	cfm	l/s	cfm	in.	mm	in.
A	KA16120A5VK	615 170 438 0	12000	127x6.4x22.2	5x1/4x7/8	M14x2	1700	2.3	1.90	4.2	20	42	32	68	3/8	13	1/2
A	KA16120B5VK	615 170 454 0	12000	127x6.4x22.2	5x1/4x7/8	5/8-11	1700	2.3	1.90	4.2	20	42	32	68	3/8	13	1/2
A	KA16120H5K	615 170 434 0	12000	127x6.4x22.2	5x1/4x7/8	HEX	1700	2.3	1.77	3.9	20	42	32	68	3/8	13	1/2
B	KA16120A5	615 170 437 0	12000	127x6.4x22.2	5x1/4x7/8	M14x2	1700	2.3	1.77	3.9	20	42	32	68	3/8	13	1/2
B	KA16120B5	615 170 439 0	12000	127x6.4x22.2	5x1/4x7/8	5/8-11	1700	2.3	1.77	3.9	20	42	32	68	3/8	13	1/2
B	KA16120H5	615 170 444 0	12000	127x6.4x22.2	5x1/4x7/8	HEX	1700	2.3	1.77	3.9	20	42	32	68	3/8	13	1/2

5/8"-11 UNC

Accessories

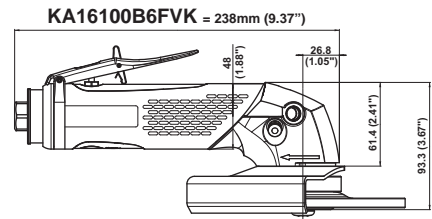
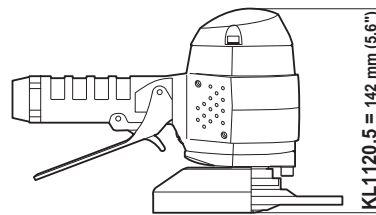
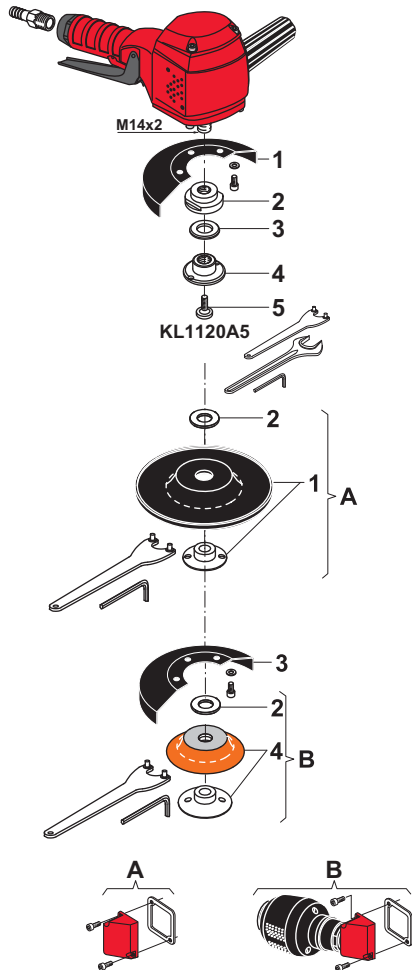

KL1120A5 - ø 127mm (5")

ACCESSORIES INCLUDED

ITEM	KL1120A5 M14x2 5/8"-11
• 3/8" air hose nipple for 10mm (3/8") ID hose	615 704 017 0
1 Wheel guard	615 504 086 0
2 Rear flange	615 503 096 0
3 Washer for wheels thickness <2mm	615 642 052 0
4 Nut	615 606 032 0
5 Safety screw	615 614 033 0
• Pin wrench, 35mm (1-3/8")	615 802 010 0
• Flat wrench, 27mm (1-1/16")	615 801 077 0
• Hex. key 6mm	615 802 056 0

OPTIONAL ACCESSORIES

Sanding with standard abrasive disc ø 127mm (5")

ITEM	KL1120A M14x2
A Soft sanding kit for abrasive disc (including item 1-2)	615 399 251 0
1 Ventilated backing pad with nut M14 (max. 12000 rpm)	615 990 127 0
• Pin wrench, 35mm (1-3/8")	615 802 010 0
• Hex key 8mm (5/16")	615 802 061 0
2 M14 Spacer	615 641 027 0

Sanding with semirigid disc ø 127mm (5")

ITEM	KL1120A M14x2
3 Wheel guard	615 504 086 0
B Sanding kit for semirigid disc (including item 4-2)	615 399 203 0
4 Backing pad with nut M14 (max. 12000 rpm)	615 990 129 0
2 M14 Spacer	615 641 027 0
• Hex key 8mm (5/16")	615 802 061 0
• Pin wrench, 35mm (1-3/8")	615 802 010 0

OTHER OPTIONAL ACCESSORIES

ITEM	PART NO.
A Silencer kit	615 396 117 0
B Silencer kit	615 399 462 0

KA16100B6FVK - ø 150mm (6")

ACCESSORIES INCLUDED

ITEM	KA16100B6FVK 5/8"-11
• Complete silencer kit	615 396 166 0
• Vibration-damping side handle	615 576 066 0
• Clamp	615 263 024 0
1 Wheel guard	615 504 202 0
2 Auto-balancer	615 990 181 0
3 Front flange	615 502 067 0
4 Safety screw	615 614 076 0
• Pin wrench, 35mm (1-3/8")	615 802 010 0
• Hex. key 6.35mm (1/4")	615 802 057 0

OPTIONAL ACCESSORIES

ITEM	KA16100B6FVK
5 Clippable silencer	615 396 957 0
6 Grease gun includes 24g (0.8oz)	615 990 149 0
• Grease for bevel gear (1kg - 2.2lb)	615 990 148 0

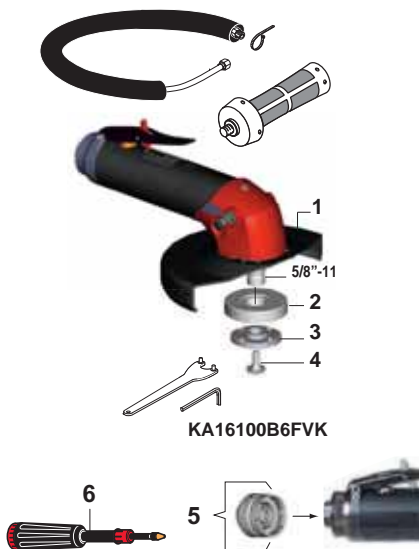

Grinders for depressed center wheels, cut-off wheels and flap wheels

Ø 127mm (5") - Ø 150mm (6")

750 and 1600 Watts (1 and 2.15 hp) - 10000 and 12000 rpm

Fixed wheel guard

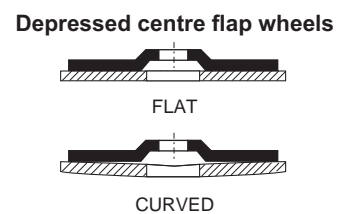
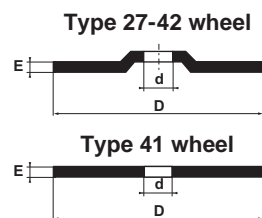

Caution: comply with the speeds recommended by component and abrasive manufacturers.

PIC REF	MODEL	PART NUMBER	FREE SPEED	WHEEL MAX CAPACITY		THREADED SPINDLE	POWER		WEIGHT		AIR CONSUMPTION AT FREE SPEED		AIR CONSUMPTION AT MAX OUTPUT		AIR INLET THREAD	HOSE INT. Ø	
			rpm	mm	in.		W	hp	kg	lb.	l/s	cfm	l/s	cfm	in.	mm	in.
A	KL1120A5	615 170 013 0	12000	127x6.4x22.2	5x1/4x7/8	M14x2	750	1.0	2.3	5.0	16	34	16	34	3/8	10	3/8
B	KA16100B6FVK	615 170 470 0	10000	150x7.0x22.2	6x1/4x7/8	5/8-11	1600	2.15	1.9	4.2	20	42	32	68	3/8	13	1/2

5/8"-11 UNC

Accessories

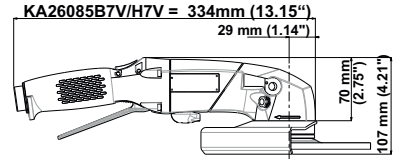
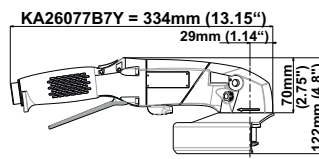
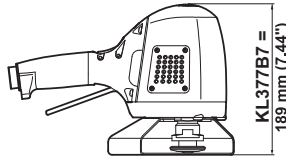
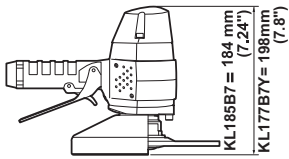

KL185B7 / KL377B7 / KL177B7Y - ø 180mm (7")

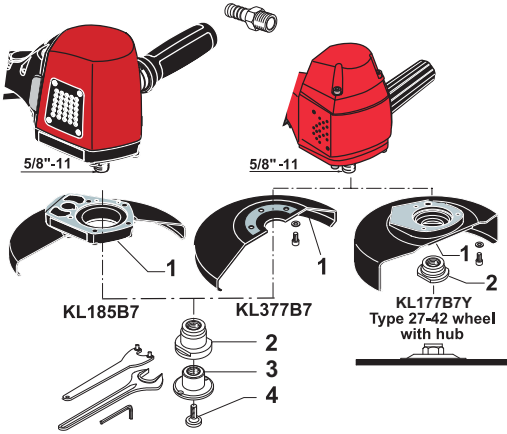

ACCESSORIES INCLUDED		KL185B7 ø 180mm (7")	KL377B7 / V ø 180mm (7")	KL177B7Y ø 180mm (7")
ITEM				
	• 1/2" air hose nipple for 16mm (5/8") ID hose	615 704 016 0	615 704 014 0	615 704 016 0
	• 1/2" air hose nipple for 13mm (1/2") ID hose			
1	Wheel guard	615 504 095 0	615 504 182 0	615 504 169 0
2	Rear flange for model B7	615 503 103 0	615 503 103 0	615 503 150 0
3	Nut	615 542 104 0	615 542 104 0	615 608 049 0
4	Safety screw	615 614 034 0	615 614 034 0	615 614 034 0
	• Pin wrench, 35mm (1-3/8")	615 802 010 0	615 802 010 0	
	• Flat wrench, 27mm (1-1/16")	615 801 077 0	615 801 077 0	615 801 077 0
	• Hex. key 6mm	615 802 056 0	615 802 056 0	615 802 056 0

OPTIONAL ACCESSORIES		KL177B7Y
ITEM		
5	Rear flange	615 503 103 0
6	Nut	615 542 104 0
7	Rear flange balancer	615 503 146 0
8	Safety screw	615 614 034 0
9	Wheel adaptor	C087920
	• Pin wrench	615 802 010 0
	• Flat wrench	615 801 077 0
	• Hex key	615 802 056 0

OTHER OPTIONAL ACCESSORIES			
ITEM	KL185B7	KL377B7	KL177B7Y
A	Silencer	615 399 462 0	615 399 462 0
B	Silencer	615 399 463 0	
C	Auto-Balancer	615 503 146 0	

KA26085B7V / KA26085H7V / KA26077B7Y - ø 180mm (7")



ACCESSORIES INCLUDED		KA26085B7V	KA26085H7V	KA26077B7Y
ITEM				
	• Vibration damping side handle	615 576 066 0	615 576 066 0	615 576 066 0
	• 1/2" air hose nipple for 16mm (5/8") ID hose	615 704 014 0	615 704 014 0	615 704 014 0
	• Rotating exhaust kit	615 397 743 5	615 397 743 5	615 397 743 5
	• Rotating handle support kit	615 397 741 5	615 397 741 5	615 397 741 5
1	Wheel guard kit	615 504 211 5	615 504 211 5	615 504 213 5
2	Auto-balancer	615 990 181 0	615 990 194 0	
3	Rear flange		615 503 164 0	615 503 153 0
4	Front flange	615 502 067 0	615 502 085 0	
5	Nut 5/8"			615 608 049 0
6	Safety screw	615 614 076 0		615 614 034 0
	• Pin wrench, 35mm (1-3/8")	615 802 010 0	615 802 010 0	
	• Hex key	615 802 056 0	615 802 056 0	615 802 056 0

OPTIONAL ACCESSORIES		KA26077B7Y
ITEM		
7	Rear flange	615 503 103 0
8	Nut	615 542 104 0
9	Rear flange balancer	615 503 146 0
10	Safety screw	615 614 034 0
11	Wheel adaptor	C087920
	• Pin wrench	615 802 010 0
	• Flat wrench	615 801 077 0
	• Hex key	615 802 056 0

OTHER OPTIONAL ACCESSORIES		KA26..
ITEM		
12	Grease gun includes 24g (0.8oz)	615 990 149 0
	• Grease for bevel gear (1kg - 2.2lb)	615 990 148 0

Grinders for depressed center wheels, cut-off wheels and flap wheels

Ø 180mm (7")

1200 to 3000 Watts (1.61 to 4.02 hp) - 7700 and 8500 rpm



A



B



C



D



E

Type 27-42 wheel

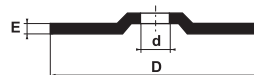

Depressed centre flap wheels

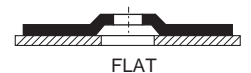

FLAT

Type 41 wheel

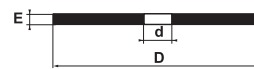

CURVED

Caution: comply with the speeds recommended by component and abrasive manufacturers.

PIC REF	MODEL	PART NUMBER	FREE SPEED	WHEEL MAX CAPACITY		THREADED SPINDLE	POWER		WEIGHT		AIR CONSUMPTION AT FREE SPEED		AIR CONSUMPTION AT MAX OUTPUT		AIR INLET THREAD	HOSE INT. Ø		
			rpm	mm	in.		W	hp	kg	lb.	l/s	cfm	l/s	cfm		in.	mm	in.
VERTICAL GRINDERS																		
A	KL185B7	615 170 012 0	8500	180x9.5x22.2	7x3/8x7/8	5/8-11	1200	1.61	2.8	6.1	16	34	27	57	1/2	13	1/2	
B	KL377B7	615 170 341 0	7700	180x9.5x22.2	7x3/8x7/8	5/8-11	3000	4.02	4.2	9.2	19	40	46	97	1/2	15	5/8	
For USA Market only (to ANSI B186.1)																		
C	KL177B7Y	615 170 182 0	7700	180x9.5x22.2	7x3/8x7/8	5/8-11	1200	1.61	2.8	6.1	8	17	25	53	1/2	13	1/2	
ANGLE GRINDERS																		
D	KA26085B7V	615 170 476 0	8500	180x9.5x22.2	7x3/8x7/8	5/8-11	2100	2.82	2.7	5.9	17	36	36	77	1/2	15	5/8	
D	KA26085H7V	615 170 489 0	8500	180x9.5x22.2	7x3/8x7/8	HEX.	2100	2.82	2.7	5.9	17	36	36	77	1/2	15	5/8	
For USA Market only (to ANSI B186.1)																		
E	KA26077B7Y	615 170 478 0	7700	180x9.5x22.2	7x3/8x7/8	5/8-11	2100	2.82	2.7	6.6	16	33	32	69	1/2	15	5/8	

5/8"-11 UNC

Accessories

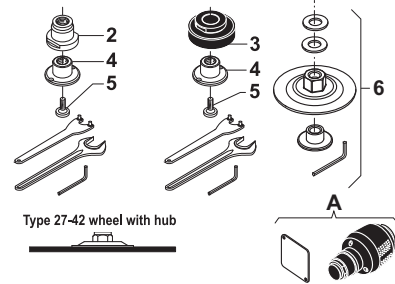
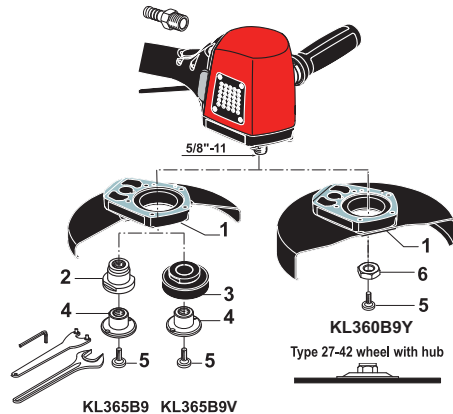
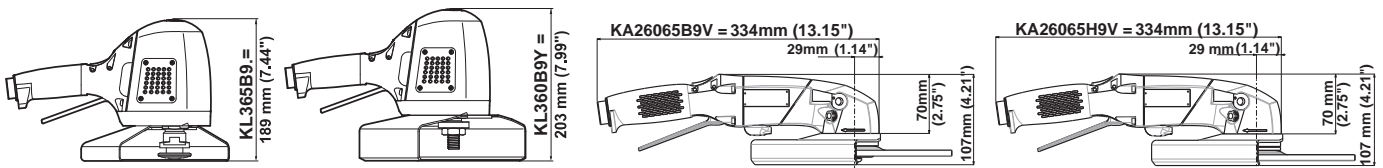

KL365B9 / KL365B9V / KL360B9Y - ø 230mm (9")

ACCESSORIES INCLUDED	KL365B9 KL365B9V	KL360B9Y
ITEM		
• 1/2" air hose nipple for 16 mm (5/8") ID hose	615 704 014 0	615 704 014 0
1 Wheel guard	615 504 183 0	615 504 180 0
2 Rear flange for model B9	615 503 103 0	
3 Auto-balancer for model B9V	615 503 146 0	
4 Nut	615 542 104 0	
5 Safety screw	615 614 034 0	615 614 034 0
6 Nut		615 608 049 0
• Flat wrench, 27mm (1-1/16")	615 801 077 0	615 801 077 0
• Pin wrench, 35mm (1-3/8")	615 802 010 0	
• Hex. Key 6mm	615 802 056 0	615 802 056 0

OPTIONAL ACCESSORIES	KL365B9	KL360B9Y
ITEM		
2 Rear flange		615 503 103 0
3 Auto-balancer		615 503 146 0
4 Nut		615 542 104 0
5 Safety screw		615 614 034 0
6 Wheel adaptor		C087920
• Pin wrench, 35mm (1-3/8")		615 802 010 0
• Flat wrench, 27mm (1-1/16")		615 801 077 0
• Hex. Key 6mm		615 802 056 0
A Silencer kit	615 399 463 0	615 399 463 0

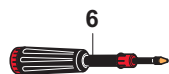

KA26065B9V / KA26065H9V - ø 230mm (9")

ACCESSORIES INCLUDED	KA26065B9V	KA26065H9V
ITEM		
• Vibration damping side handle	615 576 066 0	615 576 066 0
• 1/2" air hose nipple for 16mm (5/8") ID hose	615 704 014 0	615 704 014 0
• Rotating exhaust kit	615 397 743 5	615 397 743 5
• Rotating handle support kit	615 397 741 5	615 397 741 5
1 Wheel guard kit	615 504 211 5	615 504 211 5
2 Auto-balancer	615 990 181 0	6 159 901 940
3 Rear flange		615 503 164 0
4 Front flange	615 502 067 0	615 502 085 0
5 Safety screw	615 614 076 0	
• Pin wrench, 35mm (1-3/8")	615 802 010 0	615 802 010 0
• Hex key	615 802 056 0	615 802 056 0

OPTIONAL ACCESSORIES	PART NO.
ITEM	
6 Grease gun includes 24g (0.8oz)	615 990 149 0
• Grease for bevel gear (1kg - 2.2lb)	615 990 148 0

Grinders for depressed center wheels

∅ 230mm (9")

2100 and 2900 Watts (2.82 and 3.89 hp) - 6000 and 6500 rpm



A



B



C

Type 27-42 wheel with hub

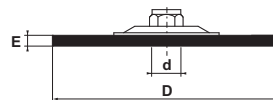

Type 27-42 wheel

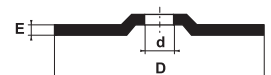

Type 41 wheel

Caution: comply with the speeds recommended by component and abrasive manufacturers.

PIC REF	MODEL	PART NUMBER	FREE SPEED	WHEEL MAX CAPACITY		THREADED SPINDLE	POWER	WEIGHT		AIR CONSUMPTION				AIR INLET THREAD		HOSE INT. ∅	
				D	xExd			W	hp	kg	lb.	l/s	cfm	l/s	cfm	in.	mm
			rpm	mm	in.	in.	W	hp	kg	lb.	l/s	cfm	l/s	cfm	in.	mm	in
VERTICAL GRINDERS																	
A	KL365B9	615 170 338 0	6500	230x6.4x22.2	9x1/4x7/8	5/8-11	2900	3.89	4.4	9.7	13	27	44	93	1/2	15	5/8
For USA Market only (to ANSI B186.1)																	
B	KL360B9Y	615 170 350 0	6000	230x6.4x22.2	9x1/4x7/8	5/8-11	2900	3.89	4.4	9.7	12	25	43	91	1/2	15	5/8
LOW VIBRATION - VERTICAL GRINDERS																	
A	KL365B9V	615 170 474 0	6500	230x6.4x22.2	9x1/4x7/8	5/8-11	2900	3.89	4.5	9.9	13	27	44	93	1/2	15	5/8
ANGLE GRINDERS																	
C	KA26065B9V	615 170 477 0	6500	230x6.4x22.2	9x1/4x7/8	5/8-11	2100	2.82	2.9	6.4	21	44	38	80	1/2	15	5/8
C	KA26065H9V	615 170 490 0	6500	230x6.4x22.2	9x1/4x7/8	HEX.	2100	2.82	2.9	6.4	21	44	38	80	1/2	15	5/8

5/8"-11 UNC

Accessories

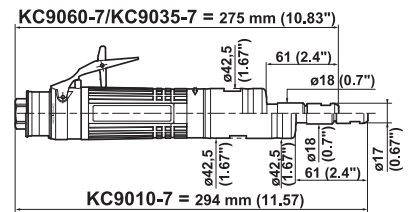
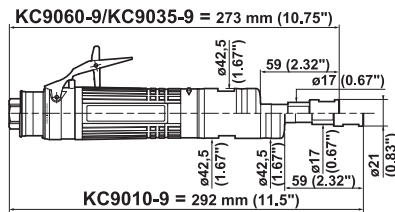

KC9060-9 / KC9035-9 / KC9010-9

ACCESSORIES INCLUDED

	PART NO.
• Series 200 resilient collet, \varnothing 5.55 to 6.35mm (1/4")	615 526 063 0
• Exhaust hose L = 1.5m (60")	615 875 113 0
• Clamp	615 873 415 0
• 3/8" air hose nipple for 10mm (3/8") ID hose	615 704 017 0
• Flat wrench, 14mm	615 801 005 0
• Flat wrench, 19mm (3/4")	615 801 076 0
• Side handle	615 576 068 0

OPTIONAL ACCESSORIES

ITEM	PART NO.
• Series 200 resilient collet, \varnothing 2.4 to 3.2mm (1/8")	615 526 061 0
• Series 200 resilient collet, \varnothing 5.2 to 6mm	615 526 062 0
• Series 200 resilient collet, \varnothing 7.2 to 8mm (5/16")	615 526 064 0
• Series 200 resilient collet, \varnothing 8.7 to 9.5mm (3/8")	615 526 065 0
1 Nut 3/8" - 24	615 608 044 0
2 Complete silencer kit	615 396 166 0
3 Clamp	615 873 115 0
4 Reinforced cloth-lined exhaust hose L = 0.75m (30")	615 875 116 0
5 Clippable silencer	615 396 655 0

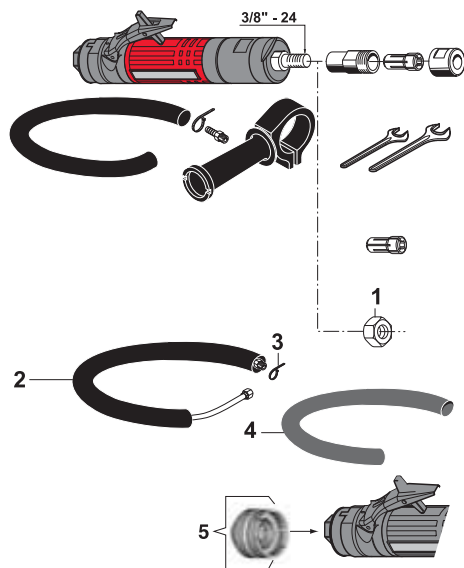

KC9060-7 / KC9035-7 / KC9010-7

ACCESSORIES INCLUDED

	PART NO.
• CNOMO collet \varnothing 6mm	615 526 049 0
• Exhaust hose L = 1.5m (60")	615 875 113 0
• Clamp	615 873 415 0
• 3/8" air hose nipple for 10mm (3/8") ID hose	615 704 017 0
• Flat wrench, 14mm (Qty 2)	615 801 005 0
• Side handle	615 576 068 0

OPTIONAL ACCESSORIES

ITEM	PART NO.
• CNOMO collet \varnothing 3mm	615 526 048 0
• CNOMO collet \varnothing 6.35mm (1/4")	615 526 050 0
• CNOMO collet \varnothing 8mm (5/16")	615 526 051 0
1 Nut 3/8" - 24	615 608 044 0
2 Complete silencer kit	615 396 166 0
3 Clamp	615 873 115 0
4 Reinforced cloth-lined exhaust hose L = 0.75m (30")	615 875 116 0
5 Clippable silencer	615 396 655 0

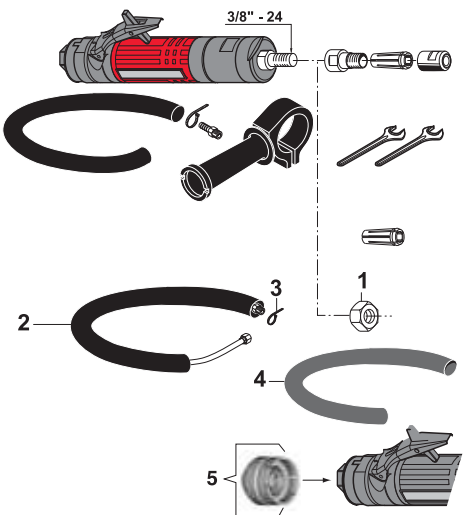

Sanders for expandable wheels, flap wheels, brushes...

900 Watts (1.21 hp) - 1000 to 5500 rpm

Supplied with series 200 Erickson collet, \varnothing 5.55 to 6.35mm (1/4")



A



B

Series 200 Erickson collet

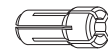

Caution: comply with the speeds recommended by component and abrasive manufacturers.

PIC REF	MODEL	PART NUMBER	FREE SPEED	COLLET MAX CAPACITY		POWER		WEIGHT		AIR CONSUMPTION AT FREE SPEED		AIR CONSUMPTION AT MAX. POWER		AIR INLET THREAD	HOSE INT. \varnothing	
			rpm	mm	in.	W	hp	kg	lb.	l/s	cfm	l/s	cfm	in.	mm	in.
A	KC9060-9	615 170 166 0	5500	9.5	3/8	900	1.21	1.38	3.0	10	21	16	34	3/8	10	3/8
A	KC9035-9	615 170 167 0	3500	9.5	3/8	900	1.21	1.38	3.0	6	13	14	30	3/8	10	3/8
B	KC9010-9	615 170 168 0	1000	9.5	3/8	900	1.21	1.45	3.2	10	21	16	34	3/8	10	3/8

Sanders for expandable wheels, flap wheels, brushes...

900 Watts (1.21 hp) - 1000 to 5500 rpm



A



B

CNOMO type collet



Caution: comply with the speeds recommended by component and abrasive manufacturers.

PIC REF	MODEL	PART NUMBER	FREE SPEED	COLLET MAX CAPACITY		POWER		WEIGHT		AIR CONSUMPTION AT FREE SPEED		AIR CONSUMPTION AT MAX. POWER		AIR INLET THREAD	HOSE INT. \varnothing	
			rpm	mm	in.	W	hp	kg	lb.	l/s	cfm	l/s	cfm	in.	mm	in.
A	KC9060-7	615 170 122 0	5500	8	5/16	900	1.21	1.38	3.0	10	21	16	34	3/8	10	3/8
A	KC9035-7	615 170 121 0	3500	8	5/16	900	1.21	1.38	3.0	6	13	14	30	3/8	10	3/8
B	KC9010-7	615 170 120 0	1000	8	5/16	900	1.21	1.45	3.2	10	21	16	34	3/8	10	3/8

Accessories

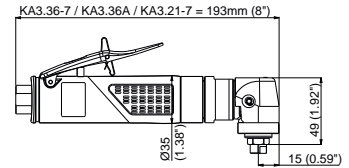
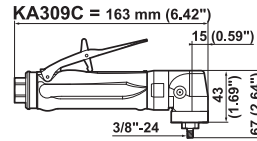
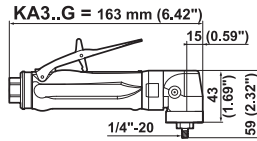
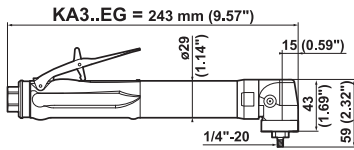

KA3..EG / KA3..G / KA309C

ACCESSORIES INCLUDED

	PART NO.
• Exhaust hose L = 0.8m (31")	615 875 106 0
• 1/4" air hose nipple for 8mm (5/16") ID hose	615 704 019 0
• Flat wrench, 11mm (7/16")	615 801 003 0

OPTIONAL ACCESSORIES

ITEM	KA309C
1 Excentric sanding head for 1" pad	615 396 251 0

OTHER OPTIONAL ACCESSORIES

ITEM	PART NO.
2 Complete silencer kit	615 396 101 0
3 Silencer	615 574 028 0
4 Clippable silencer	615 396 124 0
5 Grease gun (capacity 24g - 0.8oz)	615 990 149 0
• Grease for bevel gear (1kg - 2.2lb)	615 990 148 0

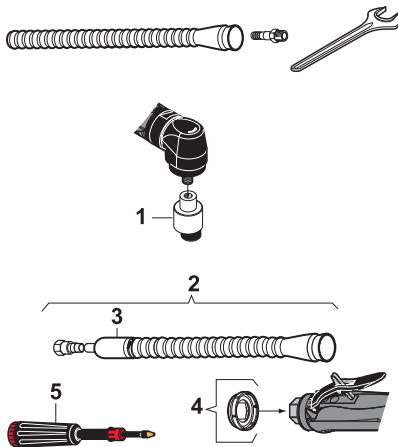

KA3.36A / KA3.36-7 / KA3.21-7

ACCESSORIES INCLUDED

ITEM	KA3.36A	KA3.36-7/KA3.21-7
• Collet \varnothing 6mm	-	615 526 079 0
• 1/4" air hose nipple for 6mm (1/4") ID hose	615 705 009 0	615 705 009 0
• Flat wrench, 10mm (3/8")	-	615 801 002 0
• Flat wrench, 14mm	-	615 801 005 0

OPTIONAL ACCESSORIES

ITEM	KA3.36A	KA3.36-7/KA3.21-7
1 Complete silencer kit	615 399 423 0	615 399 423 0
2 Exhaust hose L = 0.8m (31")	615 875 106 0	615 875 106 0
3 Backing pad \varnothing 50mm (31/32")	-	615 804 098 0
• Collet \varnothing 2mm	-	615 526 066 0
• Collet \varnothing 2.5mm	-	615 526 068 0
• Collet \varnothing 3mm	-	615 526 069 0
• Collet \varnothing 3.5mm	-	615 526 070 0
• Collet \varnothing 4mm (5/32")	-	615 526 071 0
• Collet \varnothing 4.5mm	-	615 526 073 0
• Collet \varnothing 5mm	-	615 526 075 0
• Collet \varnothing 5.5mm	-	615 526 077 0
• Collet \varnothing 6mm	-	615 526 079 0
• Collet \varnothing 6.5mm (1/4")	-	615 526 081 0
• Collet \varnothing 7mm	-	615 526 083 0
• Collet \varnothing 7.5mm	-	615 526 084 0
• Collet \varnothing 8mm (5/16")	-	615 526 088 0

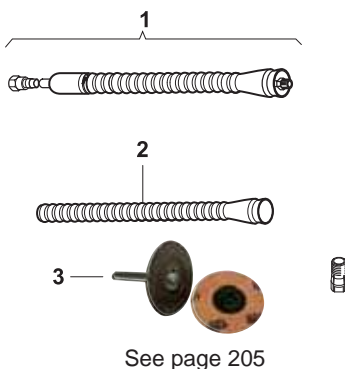

Sanders for abrasive discs

220 to 375 Watts (0.3 to 0.5 hp) - 2100 to 20000 rpm

Supplied with 1/4", 3/8" or M14 threaded spindle only



A



B



C

3/8"-24

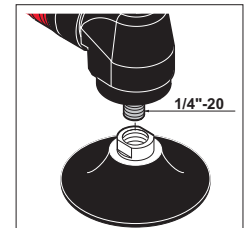

D



E

CNOMO collet, ø 6mm

Caution: comply with the speeds recommended by component and abrasive manufacturers.

PIC REF	MODEL	PART NUMBER	FREE SPEED	ABRASIVE MAX CAPACITY		THREADED SPINDLE	POWER		WEIGHT		AIR CONSUMPTION AT FREE SPEED		AIR CONSUMPTION AT MAX SPEED		AIR INLET THREAD	HOSE INT. Ø	
			rpm	ø mm	ø in.	in.	W	hp	kg	lb.	l/s	cfm	l/s	cfm	in.	mm	in.
A	KA320EG	615 170 048 0	20000	76	3	1/4-20	375	0.5	0.67	1.47	6.5	13.5	10	21	1/4	8	5/16
A	KA312EG	615 170 040 0	12000	76	3	1/4-20	375	0.5	0.67	1.47	3.0	6.5	9	19	1/4	8	5/16
B	KA320G	615 170 044 0	20000	76	3	1/4-20	375	0.5	0.50	1.10	6.5	13.5	10	21	1/4	8	5/16
B	KA318G	615 170 310 0	18000	76	3	1/4-20	375	0.5	0.50	1.10	3.0	6.5	9	19	1/4	8	5/16
B	KA312G	615 170 038 0	12000	76	3	1/4-20	375	0.5	0.50	1.10	3.0	6.5	9	19	1/4	8	5/16
B	KA309G	615 170 204 0	9000	76	3	1/4-20	220	0.3	0.50	1.10	2.2	4.7	8	17	1/4	8	5/16
C	KA309C	615 170 203 0	9000	76	3	3/8-24	220	0.3	0.50	1.10	2.2	4.7	8	17	1/4	8	5/16

LOW SPEED SANDERS

Collet Max

D	KA3.36A	615 170 518 0	3600			M14x2	300	0.4	0.65	1.4	9.5	20.0	-	-	1/4	6	1/4
E	KA3.36-7	615 170 516 0	3600	cap. 8mm (5/16")			300	0.4	0.65	1.4	9.5	20.0	-	-	1/4	6	1/4
E	KA3.21-7	615 170 517 0	2100	cap. 8mm (5/16")			300	0.4	0.65	1.4	9.5	20.0	-	-	1/4	6	1/4

1/4"-20 UNC - 3/8"-24 UNF

Accessories

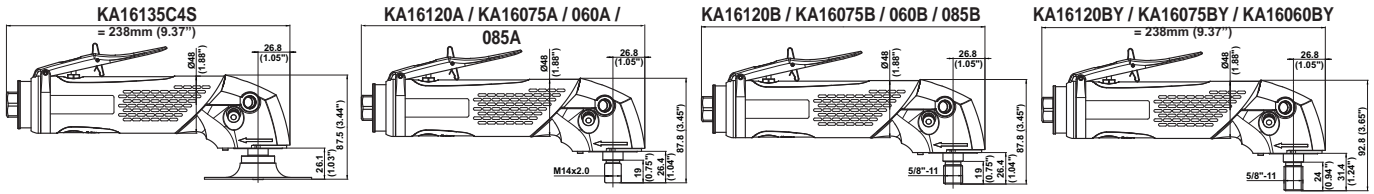

KA16135C4S / KA16120/075/060A-B-BY / KA16085A-B

ACCESSORIES INCLUDED

ITEM	KA16135C4S 3/8"-24	KA16120	KA16085 KA16075/060
• Exhaust hose L= 1.5m (60")	615 875 113 0	615 875 113 0	615 875 113 0
• Clamp	615 263 024 0	615 263 024 0	615 263 024 0
• 3/8" air hose nipple for 13mm ID hose	615 704 027 0	615 704 027 0	615 704 027 0
• Side handle			615 576 038 0
• Flat wrench, 17mm (1-1/16")	615 801 032 0	615 801 032 0	615 801 032 0
• Vibration-damping side handle	615 576 066 0	615 576 066 0	
1 Flange	615 606 515 0		
2 Backing with nut	615 990 167 0		
• Pin wrench, 20-3mm	615 802 008 0		

OPTIONAL ACCESSORIES

ITEM	Sanding with standard abrasive disc ø 127mm (5")	
	KA16120A KA16085/075/060A M14x2	KA16120B KA16085/075/060B 5/8"-11
A Sanding kit for abrasive disc (including items 4-5)	615 396 072 0	615 396 072 0
3 Finger guard	615 504 145 0	615 504 145 0
4 Ventilated backing pad with nut M14 & 5/8" (max. 12.000 rpm)	615 990 127 0	615 990 127 0
• Pin wrench, 35mm (1-3/8")	615 802 010 0	615 802 010 0
• Hex key 8mm (5/16")	615 802 061 0	615 802 061 0
5 M14 Spacer	615 641 027 0	
5 5/8" Spacer		615 642 050 0

Sanding with semirigid disc ø 127mm (5")

ITEM	KA16120A KA16085/075/060A M14x2	
B Sanding kit for semirigid disc (including items 5-6)	615 396 075 0	615 396 075 0
3 Finger guard	615 504 145 0	615 504 145 0
6 Backing pad with nut M14 (max. 12.000 rpm)	615 990 129 0*	615 990 129 0*
• Pin wrench, 35mm (1-3/8")	615 802 010 0	615 802 010 0
• Hex key 8mm (5/16")	615 802 061 0	615 802 061 0
5 M14 Spacer	615 641 027 0	615 641 027 0

Sanding

ITEM	KA16085/075/060A M14x2	KA16085/075/060B 5/8"-11	KA16075/060BY 5/8"-11
7 Sanding guard ø 180mm (7")	615 504 205 0*	615 504 205 0*	615 504 205 0*
8 Soft backing pad with nut M14 & 5/8" ø 180mm (7") (max. 8500 rpm)	615 990 133 0*	615 990 133 0*	
8 Rigid backing pad with nut M14 & 5/8" ø 180mm (7") (max. 8.500 rpm)	615 990 134 0*	615 990 134 0*	
• Pin wrench 35mm (1-3/8")	615 802 010 0	615 802 010 0	
9 Spiracool pad whit nut ø 180mm (7") (max.8500 rpm)			S091836
10 Complete kit ø 180mm (7") (max.7000 rpm) for KA16060BY			K129587
• Hex key 8mm (5/16")			615 802 061 0
11 Rigid velcro-backed backing pad ø 180mm (7") (max.8700 rpm)	615 990 145 0	615 990 146 0	
11 Rigid velcro-backed backing pad ø 150mm (6") (max.10000 rpm)	615 990 137 0	615 990 138 0	

* Spare part: Nut 6156060220 for M14 model and 6156060290 for 5/8"-11

OTHER OPTIONAL ACCESSORIES

ITEM	PART NO.
12 Semi-hard backing pad with nut M14 & 5/8" - ø 127mm (5") (max. 12.000 rpm)	615 804 074 0
13 Complete silencer kit	615 396 166 0
14 Clamp	615 263 024 0
15 Reinforced cloth-lined exhaust hose L = 0.75m (30")	615 875 116 0
16 Vibration-damping side handle	615 576 066 0
17 Clippable silencer	615 396 957 0
18 Grease gun includes 24g (0.8 oz)	615 990 149 0
• Grease for bevel gear (1 kg -2.2 lb)	615 990 148 0

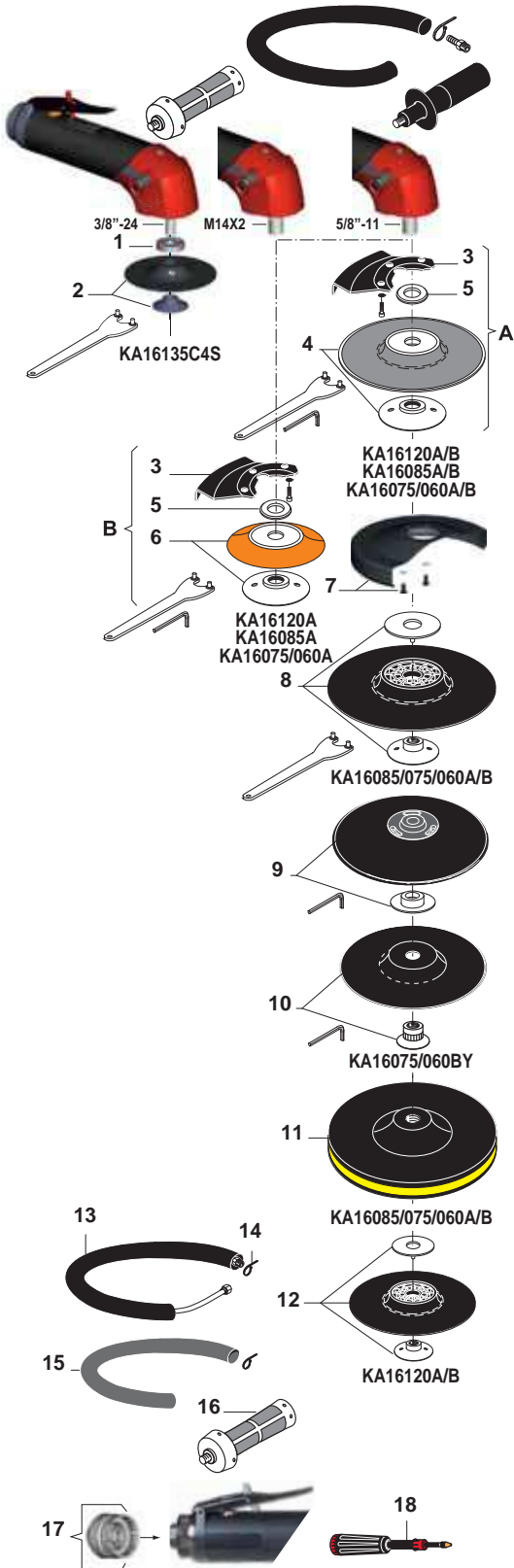

Sanders for abrasive discs

Ø 100mm (4") - Ø 127mm (5") - Ø 150mm (6") - Ø 180mm (7")
1350 to 1700 Watts (1.83 to 2.3 hp) - 6000 to 13500 rpm

Supplied with M14 or 5/8" threaded spindle only



A



B



C D



C D



Caution: comply with the speeds recommended by component and abrasive manufacturers.

PIC REF	MODEL	PART NUMBER	FREE SPEED	THREADED SPINDLE	POWER		WEIGHT		AIR CONSUMPTION				AIR INLET THREAD	HOSE INT. Ø	
			rpm	in.	W	hp	kg	lb.	l/s	cfm	l/s	cfm	in.	mm	in.
A	KA16135C4S	615 170 446 0	13500	3/8-24	1 700	2.28	1.48	3.3	25	53	35	74	3/8	13	1/2
B	KA16120A	615 170 435 0	12000	M14x2	1 700	2.28	1.39	3.0	20	42	32	68	3/8	13	1/2
B	KA16120B	615 170 445 0	12000	5/8-11	1 700	2.28	1.39	3.0	20	42	32	68	3/8	13	1/2
C/D	KA16085A	615 170 468 0	8500	M14x2	1 700	2.28	1.39	3.0	20	42	32	68	3/8	13	1/2
C/D	KA16085B	615 170 469 0	8500	5/8-11	1 700	2.28	1.39	3.0	20	42	32	68	3/8	13	1/2
C/D	KA16075A	615 170 448 0	7500	M14x2	1 500	2.01	1.39	3.0	15	32	27	57	3/8	13	1/2
C/D	KA16075B	615 170 452 0	7500	5/8-11	1 500	2.01	1.39	3.0	15	32	27	57	3/8	13	1/2
C/D	KA16060A	615 170 449 0	6000	M14x2	1 350	1.81	1.41	3.1	11	23	23	49	3/8	13	1/2
C/D	KA16060B	615 170 453 0	6000	5/8-11	1 350	1.81	1.41	3.1	11	23	23	49	3/8	13	1/2
For USA Market only (to ANSI B186.1)															
B	KA16120BY	615 170 447 0	12000	5/8-11	1 700	2.28	1.41	3.1	20	42	32	68	3/8	13	1/2
D	KA16075BY	615 170 450 0	7500	5/8-11	1 500	2.01	1.41	3.1	15	32	27	57	3/8	13	1/2
D	KA16060BY	615 170 451 0	6000	5/8-11	1 350	1.81	1.41	3.1	11	23	23	49	3/8	13	1/2

3/8"-24 UNF - 5/8"-11 UNC

Accessories

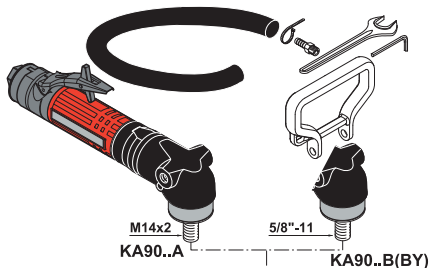
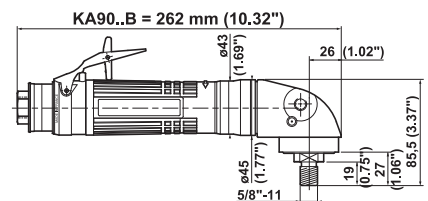
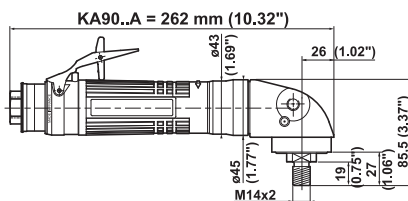
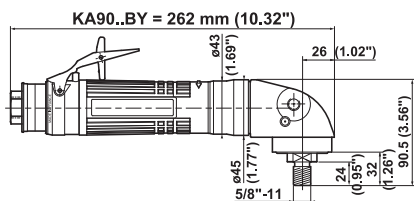

KA90..A / KA90..B / KA90..BY

ACCESSORIES INCLUDED

	PART NO.
• Exhaust hose L = 1.5m (60")	615 875 113 0
• Clamp	615 873 415 0
• 3/8" air hose nipple for 10mm (3/8") ID hose	615 704 017 0
• Support handle	615 576 069 0
• Flat wrench, 17mm (1-1/16")	615 801 032 0
• Hex key 8mm (5/16")	615 802 061 0

OPTIONAL ACCESSORIES

Sanding	KA90..A M14x2	KA90..B 5/8"-11	KA9030/20BY 5/8"-11
1 Soft backing pad with nut M14 & 5/8" ϕ 180mm (7") (max. 8500 rpm)	615 990 133 0	615 990 133 0	
1 Rigid backing pad with nut M14 & 5/8" ϕ 180mm (7") (max. 8500 rpm)	615 990 134 0	615 990 134 0	
• Pin wrench, 35mm (1-3/8")	615 802 010 0	615 802 010 0	
2 Rigid velcro-backed backing pad ϕ 180mm (7") (max. 8700 rpm)	615 990 145 0	615 990 146 0	
2 Rigid velcro-backed backing pad ϕ 150mm (6") (max. 10000 rpm)	615 990 137 0	615 990 138 0	
3 Spiracool pad with nut ϕ 180mm (7") (max. 8500 rpm)			S091836
3 Spiracool pad with nut ϕ 230mm (9") (max. 6500 rpm)			S091839
4 Complete Kit ϕ 180mm (7") (max. 7000 rpm)			K129587
• Hex. Key 8mm (5/16")			615 802 061 0

Polishing

ITEM	KA90..A	KA90..B
5 Soft backing pad with nut M14 & 5/8" ϕ 180mm (7") (max. 8500 rpm)	615 990 133 0	615 802 010 0
6 Sheepskin ϕ 180mm (7") (max. 2100 rpm)	615 845 999 0	

OTHER OPTIONAL ACCESSORIES

ITEM	PART NO.
7 Complete silencer kit	615 396 166 0
8 Clamp	615 873 115 0
9 Reinforced cloth-lined exhaust hose L = 0.75m (30")	615 875 116 0
10 Vibration-damping side handle	615 576 066 0
11 Side handle	615 576 038 0
12 Clippable silencer	615 396 655 0

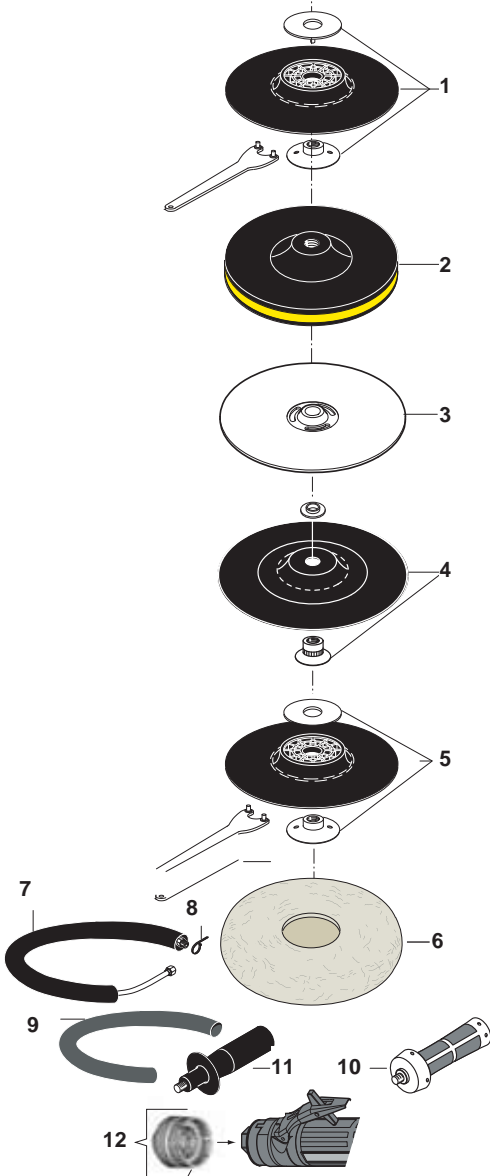

Sanders for abrasive discs polishing

∅ 150mm (6") - ∅ 180mm (7") - ∅ 230mm (9")
900 Watts (1.21 hp) - 2000 and 3000 rpm

Supplied with M14 or 5/8" threaded spindle only

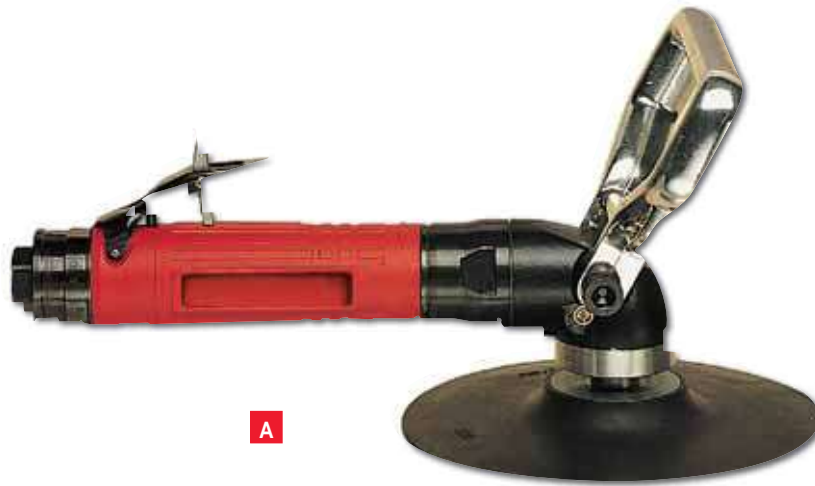

Caution: comply with the speeds recommended by component and abrasive manufacturers.

PIC REF	MODEL	PART NUMBER	FREE SPEED	THREADED SPINDLE	POWER		WEIGHT		AIR CONSUMPTION AT FREE SPEED		AIR CONSUMPTION AT MAX SPEED		AIR INLET THREAD	HOSE INLET Ø	
			rpm	in.	W	hp	kg	lb.	l/s	cfm	l/s	cfm	in.	mm	in.
A	KA9030A	615 170 098 0	3000	M14x2	900	1.21	1.6	3.5	13	27	17	36	3/8	10	3/8
A	KA9030B	615 170 099 0	3000	5/8-11	900	1.21	1.6	3.5	13	27	17	36	3/8	10	3/8
A	KA9020A	615 170 096 0	2000	M14x2	900	1.21	1.6	3.5	7	15	17	36	3/8	10	3/8
A	KA9020B	615 170 097 0	2000	5/8-11	900	1.21	1.6	3.5	7	15	17	36	3/8	10	3/8
For USA Market only (to ANSI B186.1)															
A	KA9030BY	615 170 309 0	3000	5/8-11	900	1.21	1.6	3.5	13	27	17	36	3/8	10	3/8

5/8"-11 UNC

Accessories

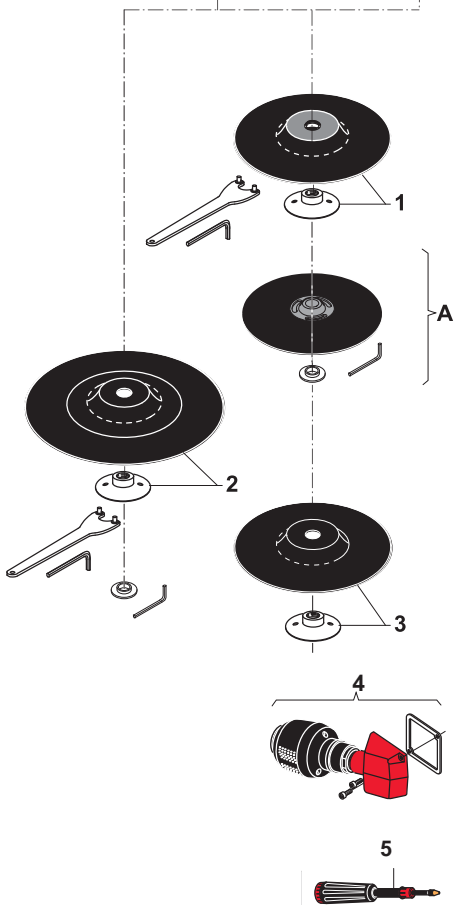
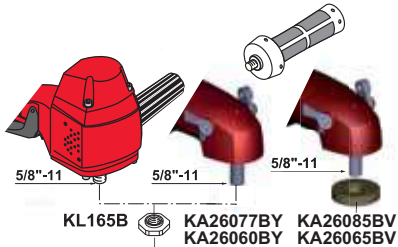
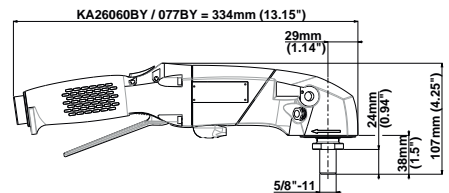
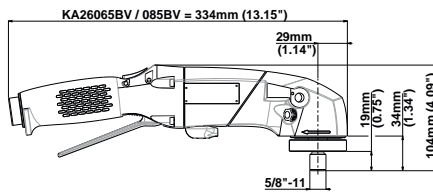
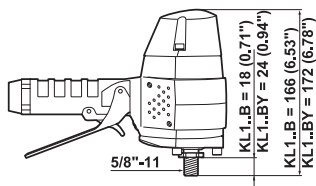

KL165B / KA26085BV / KA26065BV / KA26077BY / KA26060BY

ACCESSORIES INCLUDED

	KL165B	KA26085BV KA26065BV	KA26077BY KA26060BY
• Rear flange	615 503 107 0		615 503 107 0
• Auto-balancer		615 990 195 0	
• Rotating handle support kit		615 397 741 5	615 397 741 5
• Rotating exhaust kit		615 397 743 5	615 397 743 5
• 1/2" air hose nipple for 13mm (1/2") ID hose	615 704 016 0		
• 1/2" air hose nipple for 15mm (5/8") ID hose		615 704 014 0	615 704 014 0
• Vibration-damping side handle		615 576 066 0	615 576 066 0

OPTIONAL ACCESSORIES

Sanding with standard abrasive disc ø 180mm (7")

ITEM	KL165B	KA26085BV KA26077BY
• Rear flange for KA26085BV		615 503 107 0
1 Soft Backing pad with nut 5/8", ø 180mm (7") - (max. 8500 rpm)	615 990 133 0*	615 990 133 0*
• Pin wrench, 35mm (1-3/8")	615 802 010 0	615 802 010 0
• Hex key 8mm (5/16")	615 802 061 0	

*Spare Part: Nut 615 608 047 0

Sanding with Spiracool pad ø 180mm (7")

ITEM	KA26077BY
A Spiracool pad with nut 5/8", ø 180mm (7") - (Max. 8500 rpm)	S091836
• Pin wrench 35mm (1-3/8")	615 802 010 0

Sanding with standard abrasive disc ø 230mm (9")

	KA26065BV KA26060BY
• Rear flange for KA26085BV	615 503 107 0
2 Soft Backing pad with nut 5/8", ø 230mm (9") - (max. 6500 rpm)	615 990 141 0
• Pin wrench, 35mm (1-3/8")	615 802 010 0
• Hex key 8mm (5/16")	615 802 061 0

* Spare Part: Nut 615 608 029 0

OTHER OPTIONAL ACCESSORIES

	KL165B	KA26..
3 Rigid backing pad with nut 5/8", ø 180mm (7") - (max. 8500 rpm)		615 990 134 0
4 Silencer kit	615 399 462 0	
5 Grease gun includes 24g (0.8 oz)		615 990 149 0
• Grease for bevel gear (1kg - 2.2 lb)		615 990 148 0



Sanders for abrasive discs

ø 180mm (7") - ø 230mm (9")

1200 and 2100 Watts (1.61 and 2.82 hp) - 6000 to 8500 rpm

Supplied with 5/8" threaded spindle only



A



B



C

Caution: comply with the speeds recommended by component and abrasive manufacturers.

PIC REF	MODEL	PART NUMBER	FREE SPEED	ABRASIVE MAX CAPACITY		THREADED SPINDLE	POWER		WEIGHT		AIR CONSUMPTION				AIR INLET THREAD		HOSE INLET Ø	
			rpm	ø mm	ø in.	in.	W	hp	kg	lb.	l/s	cfm	l/s	cfm	in.	mm	in.	
VERTICAL SANDER																		
A	KL165B	615 170 011 0	6500	180	7	5/8-11	1200	1.61	2.3	5.1	6	13	25	53	1/2	13	1/2	
ANGLE SANDERS																		
B	KA26085BV	615 170 479 0	8500	180	7	5/8-11	2100	2.82	2.3	5.1	17	36	36	77	1/2	15	5/8	
B	KA26065BV	615 170 480 0	6500	180-230	7-9	5/8-11	2100	2.82	2.3	5.1	21	44	38	80	1/2	15	5/8	
ANGLE SANDERS																		
For USA Market only (to ANSI B186.1)																		
C	KA26077BY	615 170 482 0	7700	180	7	5/8-11	2100	2.82	2.3	5.1	16	33	32	69	1/2	15	5/8	
C	KA26060BY	615 170 481 0	6000	180-230	7-9	5/8-11	2100	2.82	2.3	5.1	18	38	37	77	1/2	15	5/8	

5/8"-11 UNC

Accessories

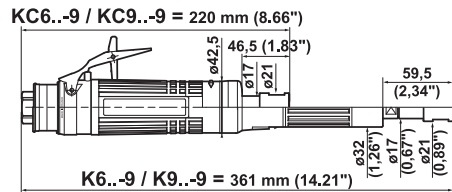
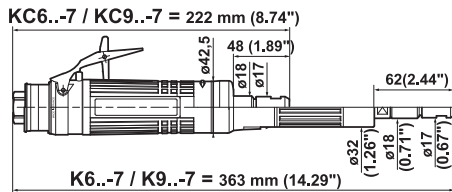

K6..- / K9..- / KC6..- / KC9..-

ACCESSORIES INCLUDED

ITEM	COLLET CNOMO	COLLET SERIES 200
1 CNOMO collet \varnothing 6mm	615 526 049 0	
2 Series 200 resilient collet, \varnothing 5.55 to 6.35mm (1/4")		615 526 063 0
• Exhaust hose L = 1.5m (60")	615 875 113 0	615 875 113 0
• Clamp	615 873 415 0	615 873 415 0
• 3/8" air hose nipple for 10mm (3/8") ID hose	615 704 017 0	615 704 017 0
• Flat wrench 14mm	615 801 005 0	615 801 005 0
• Flat wrench 19mm (3/4")		615 801 076 0

OPTIONAL ACCESSORIES

ITEM	K6./K9..-	KC6./KC9..
3 Suction cap		615 396 013 0
4 Suction cap		615 396 023 0
5 Suction cap	615 396 014 0	
6 Diamond cylinder \varnothing 27mm (1-1/16"), shank \varnothing 6mm (1/4") (20000 rpm max)	615 860 003 0	615 860 003 0
7 Diamond cylinder \varnothing 52mm (2-1/2"), shank \varnothing 6mm (1/4") (15000 rpm max)		615 860 004 0

OTHER OPTIONAL ACCESSORIES

ITEM	PART NO.
8 Complete silencer kit	615 396 166 0
9 Clamp	615 873 115 0
10 Reinforced cloth-lined exhaust hose L = 0.75m (30")	615 875 116 0
11 Clippable silencer	615 396 655 0

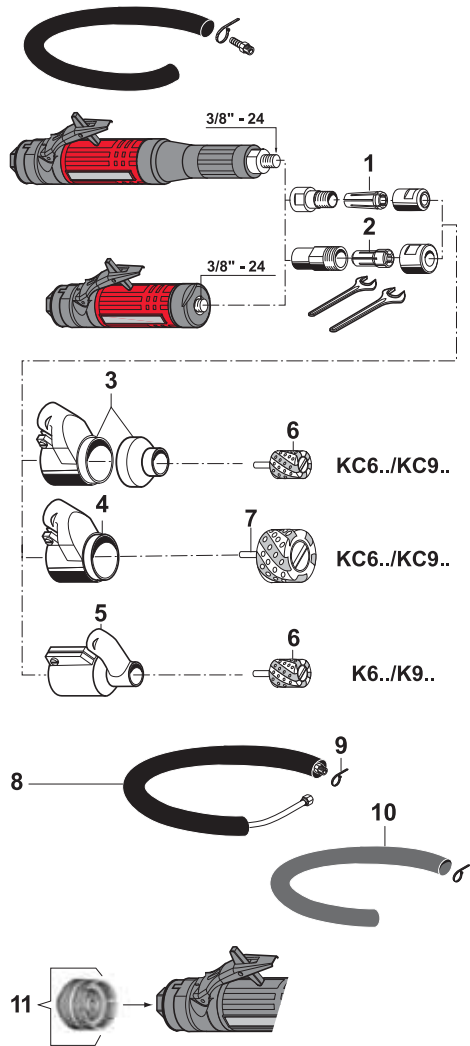

Dust extraction systems for straight grinders

600 and 900 Watts (0.8 and 1.21 hp) - 12000 to 28000 rpm



A



B



B



615 396 014 0
Vacuum hose,
ID 25mm
(1")



615 396 013 0
Vacuum hose,
ID 32mm
(1 1/4")



615 396 023 0
Vacuum hose,
ID 32mm
(1 1/4")

Caution: comply with the speeds recommended by component and abrasive manufacturers.

PIC REF	MODEL	PART NUMBER			SUCTION CAP ASSEMBLY	FREE SPEED	POWER		WEIGHT		AIR INLET THREAD
		CNOMO COLLET (-7)	SERIES 200 COLLET (-9)				W	hp	kg	lb.	
A	K628-	615 170 107 0	615 170 150 0	+	615 396 014 0	28000	600	0.80	1.3	2.9	3/8
A	K624-	615 170 106 0	615 170 151 0	+	615 396 014 0	24000	600	0.80	1.3	2.9	3/8
A	K922-	615 170 119 0	615 170 152 0	+	615 396 014 0	22000	900	1.21	1.4	3.1	3/8
A	K619-	615 170 105 0	615 170 153 0	+	615 396 014 0	19000	600	0.80	1.3	2.9	3/8
A	K918-	615 170 117 0	615 170 154 0	+	615 396 014 0	18000	900	1.21	1.4	3.1	3/8
A	K615-	615 170 104 0	615 170 155 0	+	615 396 014 0	15000	600	0.80	1.3	2.9	3/8
A	K915-	615 170 114 0	615 170 156 0	+	615 396 014 0	15000	900	1.21	1.4	3.1	3/8
A	K912-	615 170 110 0	615 170 157 0	+	615 396 014 0	12000	900	1.21	1.4	3.1	3/8
B	KC628-	615 170 126 0	615 170 158 0	+	615 396 013 0 or 615 396 023 0	28000	600	0.80	0.9	2.0	3/8
B	KC624-	615 170 125 0	615 170 159 0	+	615 396 013 0 or 615 396 023 0	24000	600	0.80	0.9	2.0	3/8
B	KC922-	615 170 130 0	615 170 160 0	+	615 396 013 0 or 615 396 023 0	22000	900	1.21	1.0	2.2	3/8
B	KC619-	615 170 124 0	615 170 161 0	+	615 396 013 0 or 615 396 023 0	19000	600	0.80	0.9	2.0	3/8
B	KC918-	615 170 129 0	615 170 162 0	+	615 396 013 0 or 615 396 023 0	18000	900	1.21	1.0	2.2	3/8
B	KC615-	615 170 123 0	615 170 163 0	+	615 396 013 0 or 615 396 023 0	15000	600	0.80	0.9	2.0	3/8
B	KC915-	615 170 128 0	615 170 164 0	+	615 396 013 0 or 615 396 023 0	15000	900	1.21	1.0	2.2	3/8
B	KC912-	615 170 127 0	615 170 165 0	+	615 396 013 0 or 615 396 023 0	12000	900	1.21	1.0	2.2	3/8

Accessories

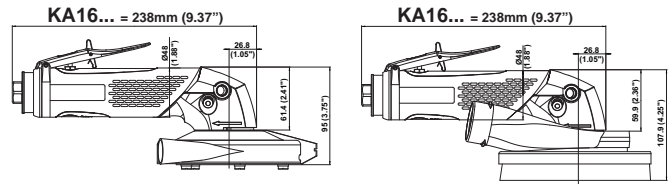

KA16120. / KA16085. / KA16075. / KA16060.

ACCESSORIES INCLUDED

ITEM	PART NO.
• Exhaust hose L = 1.5m (60")	615 875 113 0
• Clamp	615 263 024 0
• 3/8" air hose nipple for 13mm (1/2") ID hose	615 704 027 0
• Side handle	615 576 038 0
• Flat wrench, 17mm (1-1/16")	615 801 032 0

OPTIONAL ACCESSORIES

FOR COMPOSITE CUTTING

ITEM	KA16120./ KA16085. KA16075. / KA16060 ø 127mm (5")
A Dust extraction Kit for Diamond disc ø 127mm (5")	615 397 830 0
1 Manifold cutting with screws	615 504 217 0
2 Goble cover plate complete	615 504 218 0
3 Spacer 6mm - Hole 14mm	615 643 092 0
3 Spacer 6mm - Hole 16mm	615 643 091 0
4 Spacer for M14 spindle	615 643 089 0
4 Spacer for 5/8" spindle	615 643 090 0
5 Flange nut M14	615 606 046 0
5 Flange nut 5/8"	615 606 045 0
• Pin key	615 802 067 0

DUST EXTRACTION FOR COMPOSITE, NON METAL SANDING

ITEM	KA16120./ KA16085. KA16075. / KA16060 ø 127mm (5")	KA16085. KA16075. / KA16060 ø 180mm (7")
B Dust extraction Kit for disc ø 127mm (5")	615 397 828 0	
C Dust extraction Kit for disc ø 180mm (7")		615 397 829 0
6 Suction cap	615 504 194 0	615 504 194 0
7 Washer	615 643 083 0	615 643 083 0
8 Skirt with brush	615 570 234 0	615 570 231 0
9 Ventilated backing pad ø127mm (5") with nut M14 & 5/8" (max. 12000 rpm)	615 990 199 0	
10 Rigid backing pad ø180mm (7") with nut M14 & 5/8" (max. 8500 rpm)		615 990 198 0
• Pin wrench, 35mm (1-3/8")	615 802 810 0	615 802 810 0

OTHER OPTIONAL ACCESSORIES

ITEM	PART NO.
11 Diamond disc ø 127mm (5")	615 804 915 0
12 Complete silencer kit	615 396 166 0
13 Clamp	615 263 024 0
14 Reinforced cloth-lined exhaust hose L = 0.75m (30")	615 875 116 0
15 Vibration-damping side handle	615 576 066 0
16 Clippable silencer	615 396 957 0
17 Grease gun includes 24g (0.8oz)	615 990 149 0
• Grease for bevel gear (1 kg - 2.2 lb)	615 990 148 0

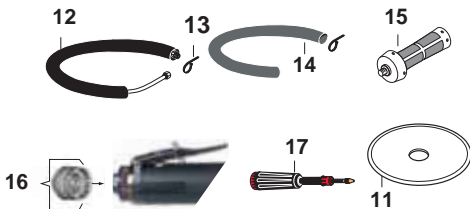
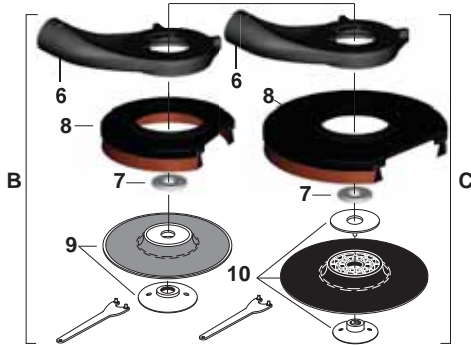

Dust extraction systems

for angle models

Ø 127mm (5") - Ø 180mm (7")

1350 to 1700 Watts (1.81 to 2.28 hp) - 6000 to 12000 rpm

A

Dust extraction casing for diamond disc Ø 127mm (5")

Vacuum hose ID 25mm (1")



B

Vacuum hose, ID 38mm (1-1/2")



B/C

Vacuum hose, ID 38mm (1-1/2")



Caution: comply with the speeds recommended by component and abrasive manufacturers.

PIC REF	MODEL	PART NUMBER		DUST EXTRACTION KIT		FREE SPEED rpm	THREADED SPINDLE in.	POWER		WEIGHT		AIR INLET THREAD in.
				Ø 127mm (5")	Ø 180mm (7")			w	hp	kg	lb	
CUTTING Ø 127mm (5") - M14 Output												
A	KA16120A	615 170 435 0	+	615 397 830 0		12000	M14x2	1700	2.28	1.39	3.0	3/8
A	KA16085A	615 170 468 0	+	615 397 830 0		8500	M14x2	1700	2.28	1.39	3.0	3/8
A	KA16075A	615 170 448 0	+	615 397 830 0		7500	M14x2	1500	2.01	1.39	3.0	3/8
A	KA16060A	615 170 449 0	+	615 397 830 0		6000	M14x2	1350	1.81	1.41	3.1	3/8
CUTTING Ø 127mm (5") - 5/8" Output												
A	KA16120B	615 170 445 0	+	615 397 830 0		12000	5/8-11	1700	2.28	1.98	4.4	3/8
A	KA16085B	615 170 469 0	+	615 397 830 0		8500	5/8-11	1700	2.28	1.39	3.0	3/8
A	KA16075B	615 170 452 0	+	615 397 830 0		7500	5/8-11	1500	2.01	1.39	3.0	3/8
A	KA16060B	615 170 453 0	+	615 397 830 0		6000	5/8-11	1350	1.81	1.41	3.1	3/8
CUTTING Ø 127mm (5") - 5/8" Output for USA Market only (to ANSI B186.1)												
A	KA16120BY	615 170 447 0	+	615 397 830 0		12000	5/8-11	1700	2.28	1.98	4.4	3/8
A	KA16075BY	615 170 450 0	+	615 397 830 0		7500	5/8-11	1500	2.01	1.39	3.0	3/8
A	KA16060BY	615 170 451 0	+	615 397 830 0		6000	5/8-11	1350	1.81	1.41	3.1	3/8
SANDING Ø 127 mm (5") & Ø 180 mm (7") - M14 & 5/8" Output												
B	KA16120A	615 170 435 0	+	615 397 828 0		12000	M14x2	1700	2.28	1.39	3.0	3/8
B	KA16120B	615 170 445 0	+	615 397 828 0		12000	5/8-11	1700	2.28	1.39	3.0	3/8
B/C	KA16085A	615 170 468 0	+	615 397 828 0	615 397 829 0	8500	M14x2	1700	2.28	1.39	3.0	3/8
B/C	KA16085B	615 170 469 0	+	615 397 828 0	615 397 829 0	8500	5/8-11	1700	2.28	1.39	3.0	3/8
B/C	KA16075A	615 170 448 0	+	615 397 828 0	615 397 829 0	7500	M14x2	1500	2.01	1.39	3.0	3/8
B/C	KA16075B	615 170 452 0	+	615 397 828 0	615 397 829 0	7500	5/8-11	1500	2.01	1.39	3.0	3/8
B/C	KA16060A	615 170 449 0	+	615 397 828 0	615 397 829 0	6000	M14x2	1350	1.81	1.41	3.1	3/8
B/C	KA16060B	615 170 453 0	+	615 397 828 0	615 397 829 0	6000	5/8-11	1350	1.81	1.41	3.1	3/8

5/8"-11 UNC

Accessories

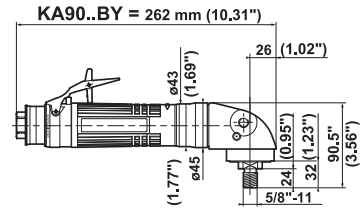
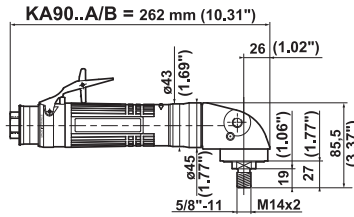
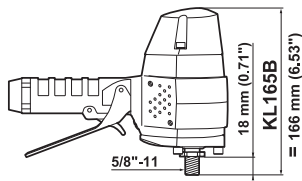

KL165B / KA90.. A / KA90..B / KA90..BY

ACCESSORIES INCLUDED

	KL165B	KA90..A KA90..B / BY
• Rear flange	615 503 107 0	
• 1/2" air hose nipple for 13mm (1/2") ID hose	615 704 016 0	
• Exhaust hose L= 1.5m (60")		615 875 113 0
• Clamp		615 873 415 0
• 3/8" air hose nipple for 10mm (3/8") ID hose		615 704 017 0
• Support handle		615 576 069 0

OPTIONAL ACCESSORIES For sanding materials

ITEM	KL165B non metallic Fibre disc ø 180mm (7")	KL165B metallic Fibre disc ø 180mm (7")
• Complete kit (including item 1-2-3)	615 399 364 0	615 399 365 0
1 Suction cap	615 399 359 0	615 399 360 0
2 Washer Z16U	615 642 050 0	615 642 050 0
3 Rigid backing pad with nut 5/8" ø 180mm (7") (Max. 8500 rpm)	615 990 134 0	615 990 134 0
• Pin wrench, 35mm (1-3/8")	615 802 010 0	615 802 010 0
• Hex key 8mm (5/16")	615 802 061 0	615 802 061 0

For sanding metallic materials

ITEM	KA90..A / B ø 180mm (7")	KA90..BY ø 180mm (7")
A Suction cap	615 396 125 0	615 396 125 0
4 Rigid backing pad with nut M14 & 5/8" ø 180mm (7") (Max. 8500 rpm)	615 990 134 0	615 990 134 0
• Pin wrench, 35mm (1-3/8")	615 802 010 0	
5 Spiracool pad (Max. 8500 rpm)		S091836
6 Complete kit (Max. 7000 rpm)		K129587
• Hex key 8mm (5/16")		615 802 061 0

For sanding non metallic materials

ITEM	KA90..A / B ø 180mm (7")	KA90..BY ø 180mm (7")
B Suction cap (including item 6-7)	615 396 126 0	615 396 126 0
4 Rigid backing pad with nut M14 & 5/8" ø 180mm (7") (Max. 8500 rpm)	615 990 134 0	615 990 134 0
7 Spare brush	615 570 233 0	
• Pin wrench, 35mm (1-3/8")	615 802 010 0	
5 Spiracool pad (Max. 8500 rpm)		S091836
6 Complete kit (Max. 7000 rpm)		K129587
• Hex key 8mm (5/16")		615 802 061 0

OTHER OPTIONAL ACCESSORIES

ITEM	KL165B	KA90..A KA90..B / BY
C Silencer kit	615 399 462 0	
8 Complete silencer kit		615 396 166 0
9 Clamp		615 873 115
10 Reinforced cloth-lined exhaust hose L = 0.75m (30")		615 875 116 0
11 Vibration-damping side handle		615 576 066 0
12 Side handle		615 576 038 0
13 Clippable silencer		615 396 655 0

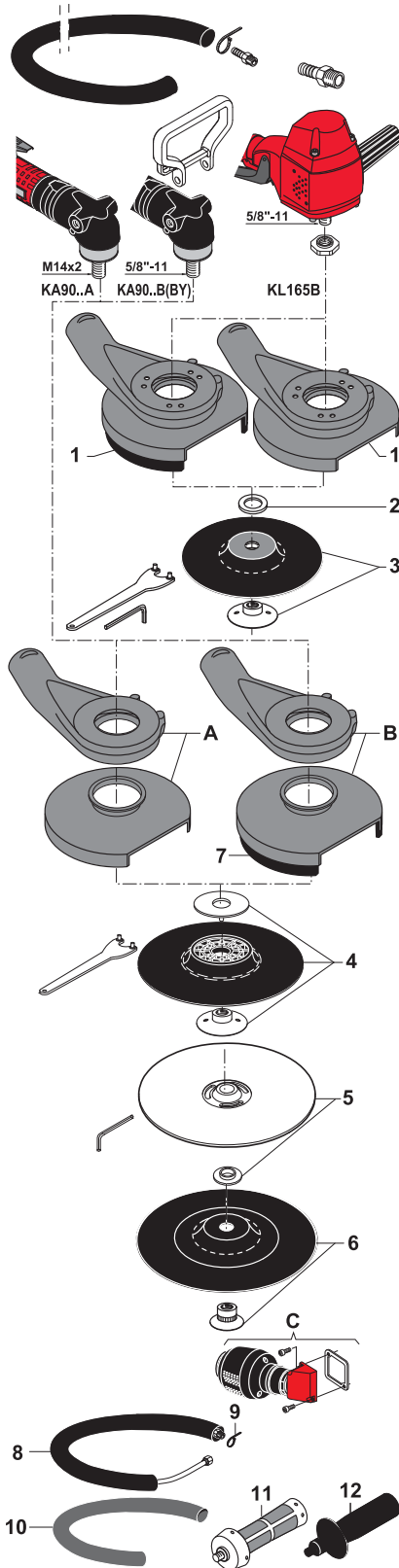

Dust extraction systems for vertical and angle sanders

∅ 180mm (7")

900 and 1200 Watts (1.21 and 1.61 hp) - 2000 to 6500 rpm

Supplied with M14 & 5/8" threaded spindle only



A



B

For standard abrasive disc for non metallic materials

KL165

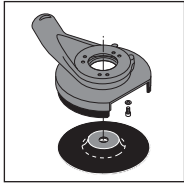

615 399 364 0

KA90..

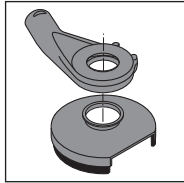

615 396 126 0

For standard abrasive disc for metallic materials

KL165

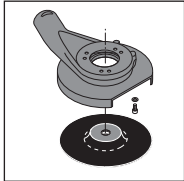

615 399 365 0

KA90..

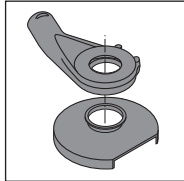

615 396 125 0

Vacuum hose, ID 38mm (1-1/2")



C

Caution: comply with the speeds recommended by component and abrasive manufacturers.

PIC REF	MODEL	PART NUMBER		DUST EXTRACTION KIT	FREE SPEED	THREADED SPINDLE	POWER		WEIGHT		AIR INLET THREAD
							W	hp	kg	lb.	
				∅ 180 mm (7")	rpm	in					in.
VERTICAL SANDER											
A	KL165B	615 170 011 0	+	615 399 364 0 or 615 399 365 0	6500	5/8-11	1 200	1.61	2.3	5.1	1/2
ANGLE SANDERS											
B	KA9030A	615 170 098 0	+	615 396 126 0 or 615 396 125 0	3000	M14x2	900	1.21	1.6	3.5	3/8
B	KA9030B	615 170 099 0	+	615 396 126 0 or 615 396 125 0	3000	5/8-11	900	1.21	1.6	3.5	3/8
B	KA9020A	615 170 096 0	+	615 396 126 0 or 615 396 125 0	2000	M14x2	900	1.21	1.6	3.5	3/8
B	KA9020B	615 170 097 0	+	615 396 126 0 or 615 396 125 0	2000	5/8-11	900	1.21	1.6	3.5	3/8
ANGLE SANDERS for USA Market only (to ANSI B186.1)											
C	KA9030BY	615 170 309 0	+	615 396 126 0 or 615 396 125 0	3000	5/8-11	900	1.21	1.6	3.5	3/8

5/8"-11 UNC

Accessories

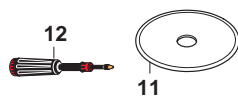
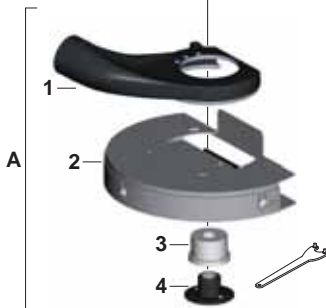
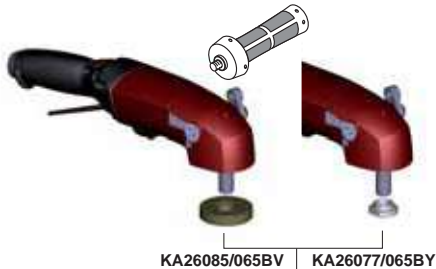
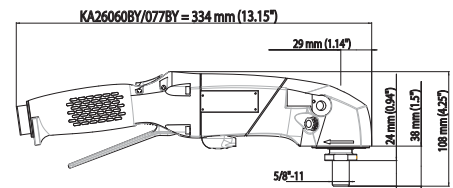
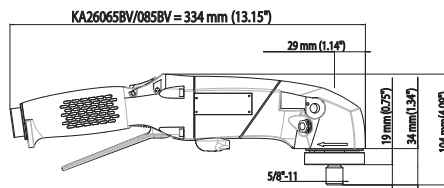

KA26085BV / KA26065BV / KA26077BY / KA26060BY

ACCESSORIES INCLUDED

	KA26085BV KA26065BV	KA26077BY KA26060BY
• Auto-balancer	615 990 195 0	
• Rear flange		615 503 107 0
• Rotating handle support kit	615 397 741 5	615 397 741 5
• Rotating exhaust kit	615 397 743 5	615 397 743 5
• Vibration-damping side handle	615 576 066 0	615 576 066 0

OPTIONAL ACCESSORIES

FOR COMPOSITE CUTTING

ITEM	KA26085BV/065BV KA26077BY/060BY ø 180mm (7")
A Dust extraction Kit for Diamond disc ø 180mm (7")	6 153 978 440
1 Manifold cutting with screws	615 504 220 0
2 Goble cover plate complete	615 504 221 0
3 Spacer - hole 5/8"	615 643 090 0
4 Flange nut 5/8"	615 606 048 0
• Pin wrench, 35mm (1-3/8")	615 802 067 0

DUST EXTRACTION FOR COMPOSITE, NON METAL SANDING

ITEM	KA26085BV/065BV KA26077BY/060BY ø 180mm (7")
B Dust extraction Kit for disc ø 180mm (7")	615 397 843 0
5 Manifold with screws	615 504 219 0
6 Skirt with brush	615 570 231 0
7 Spacer 9mm	615 643 093 0
8 Spacer 6mm - Hole 16mm (5/8")	615 643 091 0
9 Rigid backing pad ø180mm (7") (max. 8500rpm)	615 990 200 0
10 Flange nut 5/8"	615 606 047 0
• Pin wrench, 35mm (1-3/8")	615 802 067 0

OTHER OPTIONAL ACCESSORIES

ITEM	PART NO.
11 Diamond disc ø 180mm (7")	615 811 145 0
12 Grease gun includes 24g (0.8oz)	615 990 149 0
• Grease for bevel gear (1 kg - 2.2 lb)	615 990 148 0

Dust extraction systems

for angle models

Ø 180mm (7")

2100 Watts (2.82 hp) - 6000 to 8500 rpm



A

Dust extraction casing for diamond disk Ø 180mm (7")
Vacuum hose, ID 38mm (1-1/2")



B

Vacuum hose, ID 38mm (1-1/2")

Caution: comply with the speeds recommended by component and abrasive manufacturers.

PIC REF	MODEL	PART NUMBER		DUST EXTRACTION KIT	FREE SPEED	THREADED SPINDLE	POWER		WEIGHT		AIR INLET THREAD
				Ø 180mm (7")	rpm	in.	W	hp	kg	lb	in.
CUTTING Ø 180mm (7")											
A	KA26085BV	615 170 479 0	+	615 397 844 0	8500	5/8-11	2100	2.82	2.3	5.1	1/2
A	KA26065BV	615 170 480 0	+	615 397 844 0	6500	5/8-11	2100	2.82	2.3	5.1	1/2
CUTTING Ø 180mm (7") for USA Market only (to ANSI B186.1)											
A	KA26077BY	615 170 482 0	+	615 397 844 0	7700	5/8-11	2100	2.82	2.3	5.1	1/2
A	KA26060BY	615 170 481 0	+	615 397 844 0	6000	5/8-11	2100	2.82	2.3	5.1	1/2
SANDING Ø 180mm (7")											
B	KA26085BV	615 170 479 0	+	615 397 843 0	8500	5/8-11	2100	2.82	2.3	5.1	1/2
B	KA26065BV	615 170 480 0	+	615 397 843 0	6500	5/8-11	2100	2.82	2.3	5.1	1/2
SANDING Ø 180mm (7") for USA Market only (to ANSI B186.1)											
B	KA26077BY	615 170 482 0	+	615 397 843 0	7700	5/8-11	2100	2.82	2.3	5.1	1/2
B	KA26060BY	615 170 481 0	+	615 397 843 0	6000	5/8-11	2100	2.82	2.3	5.1	1/2

5/8"-11 UNC

Accessories

SXR. = 127 mm (5")

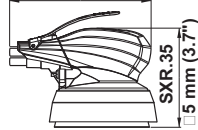

SXR.V/C = 186 mm (7.32")

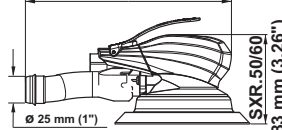

SXR.C = 133 mm (5.2")

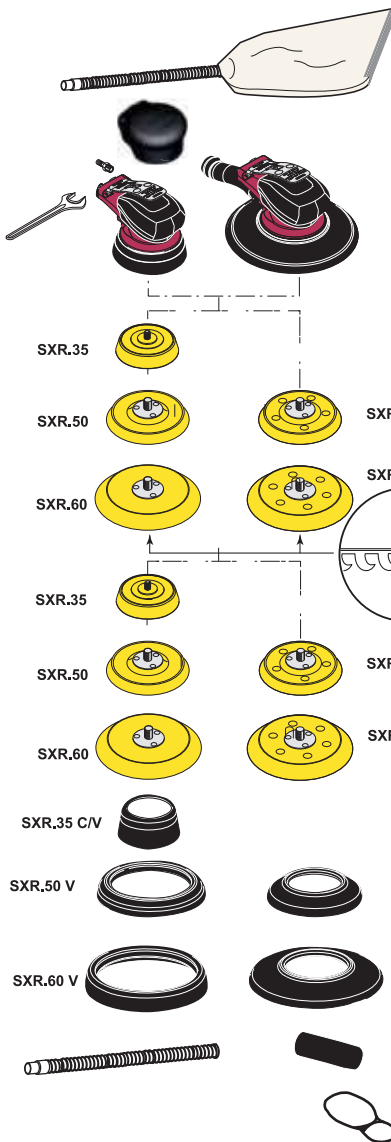
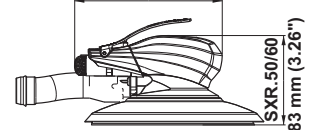

SXR.35. / SXR.50. / SXR.60.

ACCESSORIES INCLUDED

	PART NO.
• 1/4" air hose nipple for 6mm (1/4") ID hose	615 705 009 0
• Small grip (medium-size grip fitted on sander)	615 303 108 0
• Flat wrench 26mm across flats	615 801 078 0
• Complete dust extraction kit for SXRA..V and SXRB..V version	615 396 264 0

Pads:
Thread 5/16"-24

	For Hook & Loop abrasive	For Hook & Loop abrasive (V) or (C) with holes
• Pad ø 89mm (3.5") - 80gr - SXR(.)35(.)	615 990 158 0	-
• Pad ø 127mm (5") - 100gr - SXR(.)50	615 990 156 0	615 990 157 0
• Pad ø 150mm (6") - 130gr - SXR(.)60	615 990 154 0	615 990 155 0

OPTIONAL ACCESSORIES

Pads:
Thread 5/16"-24

	For self-adhesive abrasive	For self-adhesive abrasive (V) or (C) with holes
• Pad ø 89mm (3.5") - 80gr - SXR(.)35(.)	615 990 163 0	-
• Pad ø 127mm (5") - 100gr - SXR(.)50	615 990 161 0	615 990 162 0
• Pad ø 150mm (6") - 130gr - SXR(.)60	615 990 159 0	615 990 160 0

Vacuum skirts

• Vacuum skirt for SXR(.)35(.)	615 350 110 0
• Vacuum skirt for SXR(.)50C	615 350 107 0
• Vacuum skirt for SXR(.)60C	615 350 106 0
• Vacuum skirt for SXR(.)50V	615 350 103 0
• Vacuum skirt for SXR(.)60V	615 350 102 0

Adaptor

• Vacuum hose adaptor ø 25mm (1") / ø 32mm (1-1/4")	615 350 117 0
• Vacuum hose adaptor ø 25mm (1") / ø 28mm (1-1/8")	615 804 448 0

Hose

• Dust extraction hose ø 25mm (1") L = 1.5m (60")	615 396 263 0
---	---------------

Bail Hook

• Bail hook	615 571 060 0
-------------	---------------

PAD DIMENSIONS

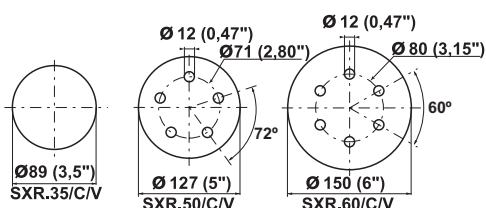

Random orbital sanders for abrasive discs

Ø 89mm (3.5") - Ø 127mm (5") - Ø 150mm (6")

210 Watts (0.3 hp) - 12000 rpm

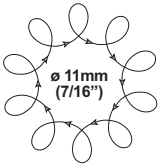

For all your large applications

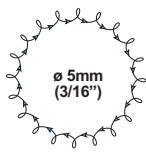

For all your versatile applications



For a best finish



SXR(.)35



SXR(.)35C



SXR(.)35V



SXR(.)50



SXR(.)50C



SXR(.)50V



SXR(.)60



SXR(.)60C



SXR(.)60V

Supplied kit



HOW TO SELECT YOUR SX SANDER — Eg: SXRA35C - SXR model / orbit Ø 2.4mm (3/32") / pad Ø 89mm (3.5") / with dust extraction

SX R A 35 C

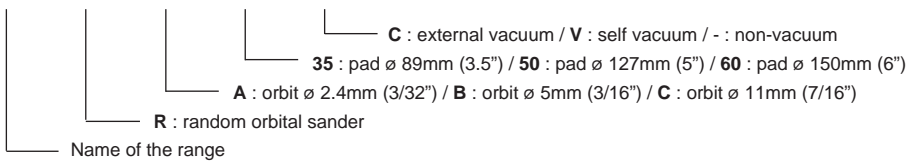

*Sanders equipped with PSA pad

Caution: comply with the speeds recommended by component and abrasive manufacturers.

PAD SIZE		MODEL	PART NUMBER	MODEL	PART NUMBER	MODEL	PART NUMBER	WEIGHT		AIR CONSUMPTION AT MAX. OUTPUT		AIR INLET THREAD		HOSE INT Ø	
mm	in.							kg	lb.	l/s	cfm	in.	mm	in.	

RANDOM ORBITAL SANDERS, ORBIT Ø 11mm (7/16")

		Non-vacuum		External vacuum		Self vacuum									
Ø 150	6	SXRC60	615 170 462 0	SXRC60C	615 170 463 0	SXRC60V	615 170 464 0	0.88	1.94	8.0	16.6	1/4	6	1/4	

RANDOM ORBITAL SANDERS, ORBIT Ø 5mm (3/16")

		Non-vacuum		External vacuum		Self vacuum									
Ø 89	3.5	SXRB35	615 170 209 0	SXRB35C	615 170 215 0	SXRB35V	615 170 212 0	0.8	1.7	8.0	16.6	1/4	6	1/4	
Ø 127	5	SXRB50	615 170 210 0	SXRB50C	615 170 216 0	SXRB50V	615 170 213 0	0.8	1.7	8.0	16.6	1/4	6	1/4	
Ø 127	5	SXRB50*	615 170 300 0					0.8	1.7	8.0	16.6	1/4	6	1/4	
Ø 150	6	SXRB60	615 170 211 0	SXRB60C	615 170 217 0	SXRB60V	615 170 214 0	0.8	1.7	8.0	16.6	1/4	6	1/4	
Ø 150	6	SXRB60*	615 170 317 0					0.8	1.7	8.0	16.6	1/4	6	1/4	

RANDOM ORBITAL SANDERS, ORBIT Ø 2.4mm (3/32")

		Non-vacuum		External vacuum		Self vacuum									
Ø 89	3.5	SXRA35	615 170 218 0	SXRA35C	615 170 224 0	SXRA35V	615 170 221 0	0.8	1.7	8.0	16.6	1/4	6	1/4	
Ø 127	5	SXRA50	615 170 219 0	SXRA50C	615 170 225 0	SXRA50V	615 170 222 0	0.8	1.7	8.0	16.6	1/4	6	1/4	
Ø 150	6	SXRA60	615 170 220 0	SXRA60C	615 170 226 0	SXRA60V	615 170 223 0	0.8	1.7	8.0	16.6	1/4	6	1/4	

Accessories

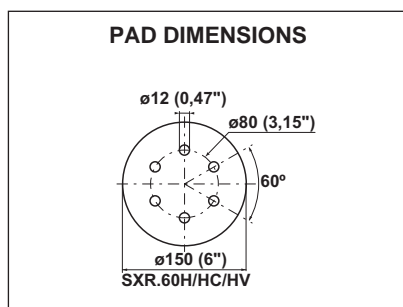
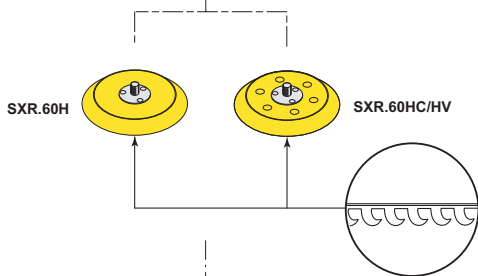
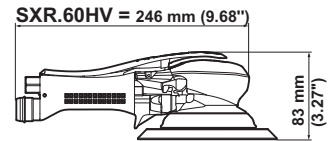
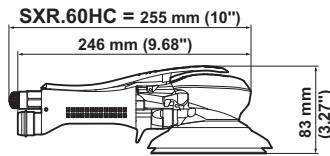
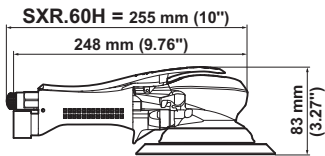

SXR.60H.

ACCESSORIES INCLUDED

	PART NO.
• 1/4" air hose nipple for 6mm (1/4") ID hose	615 705 009 0
• Small grip (medium-size grip fitted on sander)	615 303 108 0
• Flat wrench 26mm across flats	615 801 078 0
• Complete dust extraction kit for SXR.60HV version	615 396 264 0

Pads:
Thread 5/16"-24

For Hook
& Loop
abrasive

For Hook
& Loop
abrasive
(V) or (C)
with holes

- Pad \varnothing 150mm (6") - 130gr - SXR(.)60

615 990 154 0

615 990 155 0

OPTIONAL ACCESSORIES

Pads:
Thread 5/16"-24

For
self-adhesive
abrasive

For
self-adhesive
abrasive
(V) or (C)
with holes

- Pad \varnothing 150mm (6") - 130gr - SXR(.)60

615 990 159 0

615 990 160 0

Vacuum skirts

- Vacuum skirt for SXR(.)60HC
- Vacuum skirt for SXR(.)60HV

615 350 106 0

615 350 102 0

Adaptor

- Vacuum hose adaptor \varnothing 25mm (1") / \varnothing 32mm (1-1/4")
- Vacuum hose adaptor \varnothing 25mm (1") / \varnothing 28mm (1-1/8")

615 350 117 0

615 804 448 0

Hose

- Dust extraction hose \varnothing 25mm (1") L = 1.5m (60")

615 396 263 0

Bail Hook

- Bail hook

615 571 060 0



Random orbital sanders for abrasive discs

∅ 150mm (6")

210 Watts (0.3 hp) - 12000 rpm

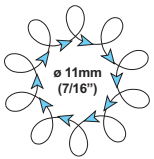

∅ 11mm
(7/16")

For all your large applications

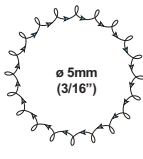

∅ 5mm
(3/16")

For all your versatile applications



SXR.60H



SXR.60HC



SXR.60HV

HOW TO SELECT YOUR SX SANDER – SXR60H - SXR model / orbit 5mm (3/16") / pad ∅ 150mm (6") / Two handed / non vacuum

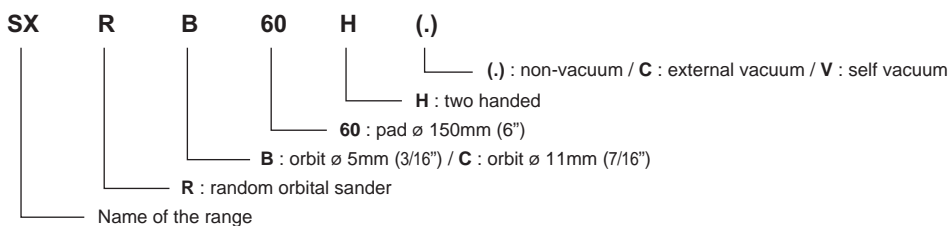

*Sanders equipped with PSA pad

Caution: comply with the speeds recommended by component and abrasive manufacturers.

PAD SIZE		MODEL	PART NUMBER	MODEL	PART NUMBER	MODEL	PART NUMBER	WEIGHT		AIR CONSUMPTION AT MAX. OUTPUT		AIR INLET THREAD	HOSE INT ∅	
mm	in.							kg	lb.	l/s	cfm	in.	mm	in.

RANDOM ORBITAL SANDERS, ORBIT ∅ 11mm (7/16")

		Non-vacuum		External vacuum		Self vacuum									
∅ 150	6	SXRC60H	615 170 465 0	SXRC60HC	615 170 466 0	SXRC60HV	615 170 467 0	0.98	2.16	8.0	16.6	1/4	6	1/4	

RANDOM ORBITAL SANDERS, ORBIT ∅ 5mm (3/16")

		Non-vacuum		External vacuum		Self vacuum									
∅ 150	6	SXRB60H	615 170 355 0	SXRB60HC	615 170 362 0	SXRB60HV	615 170 359 0	0.9	2.0	8.0	16.6	1/4	6	1/4	
∅ 150	6	SXRB60H*	615 170 356 0					0.9	2.0	8.0	16.6	1/4	6	1/4	

Accessories

SXO.. = 127 mm (5")

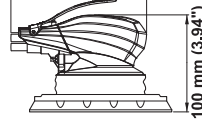

SXO..V = 186 mm (7.32")

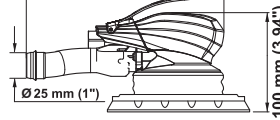

SXO..C = 133 mm (5.24")

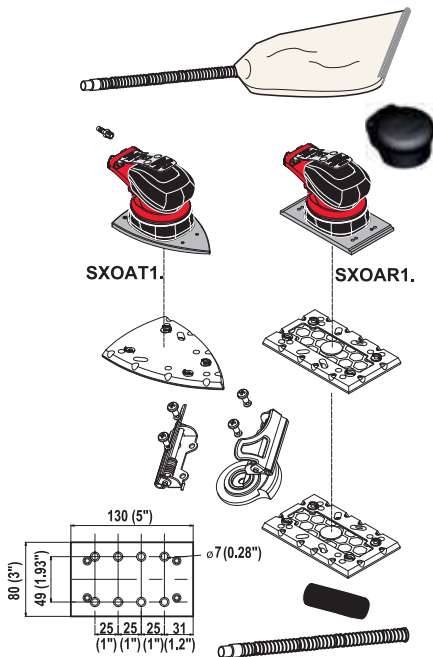
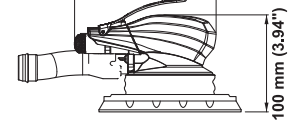

SXOAR1. / SXOAT1.

ACCESSORIES INCLUDED

	PART NO.
• 1/4" air hose nipple for 6mm (1/4") ID hose	615 705 009 0
• Small grip (medium-size grip fitted on sander)	615 303 108 0
• Complete dust extraction kit for SXOAR..V version	615 396 264 0

Pad for Hook & Loop abrasive

	PART NO.
• Pad 80x130mm (3x5") for SXOAR..	615 350 121 0
• Pad 147x100mm (6x4") for SXOAT1..	615 350 122 0

OPTIONAL ACCESSORIES

	PART NO.
• Paper holder kit	615 396 413 0
• Pad 80x130mm (3x5") for SXOAR..	615 350 123 0

Adaptor

• Vacuum hose adaptor \varnothing 25mm (1") / \varnothing 32mm (1-1/4")	615 350 117 0
• Vacuum hose adaptor \varnothing 25mm (1") / \varnothing 28mm (1-1/8")	615 804 448 0

Hose

• Dust extraction hose \varnothing 25mm (1") L = 1.5m (60")	615 396 263 0
---	---------------

PAD DIMENSIONS

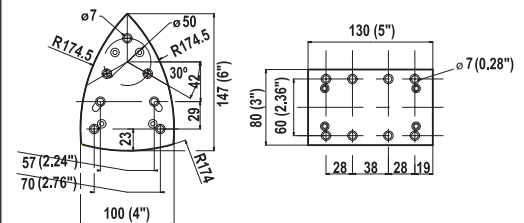

Orbital sanders for abrasive sheets

80 x 130mm (3"x 5") - 147 x 100mm (6"x 4")

210 Watts (0.3 hp) - 10000 rpm



S XOAR1



S XOAR1C



S XOAR1V



S XOAT1



S XOAT1C



S XOAT1V



S XOAR1 equipped with paper holder kit P.N 615 396 413 0

HOW TO SELECT YOUR SXO SANDER — Eg: SXOAT1C - SXO model / orbit \varnothing 2.4mm (3/32") iron pad / with dust suction

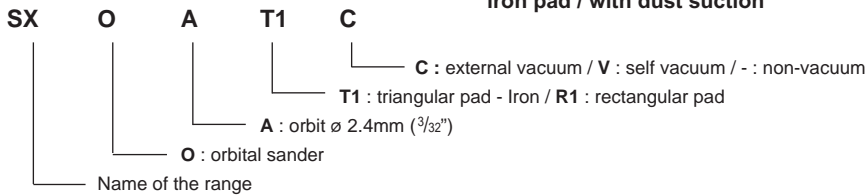

Supplied kit



Caution: comply with the speeds recommended by component and abrasive manufacturers.

PAD SIZE		MODEL	PART NUMBER	MODEL	PART NUMBER	MODEL	PART NUMBER	WEIGHT		AIR CONSUMPTION AT MAX. OUTPUT		AIR INLET THREAD	HOSE INT. \varnothing		
mm	in.							kg	lb.	l/s	cfm	in.	mm	in.	
ORBITAL SANDERS, ORBIT \varnothing 2.4mm (3/32")															
		Non-vacuum			External vacuum			Self vacuum							
80x130	3x5	S XOAR1	615 170 233 0	S XOAR1C	615 170 237 0	S XOAR1V	615 170 235 0	1.0	2.2	8.0	16.6	1/4	6	1/4	
147x100	6x4	S XOAT1	615 170 234 0	S XOAT1C	615 170 238 0	S XOAT1V	615 170 236 0	1.0	2.2	8.0	16.6	1/4	6	1/4	

Accessories

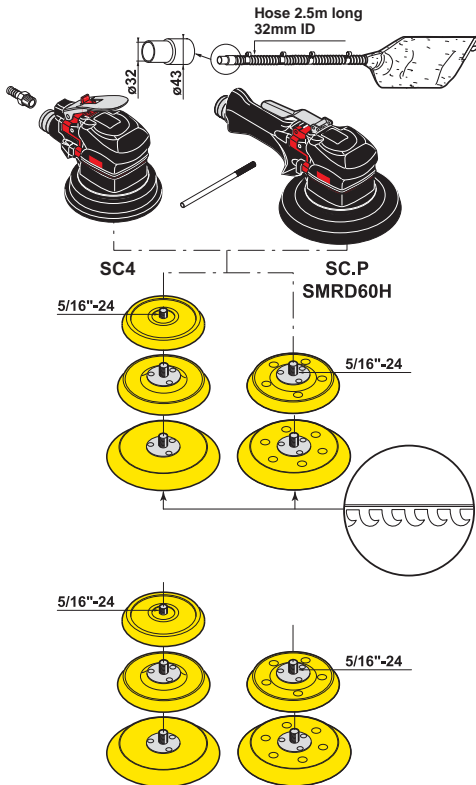
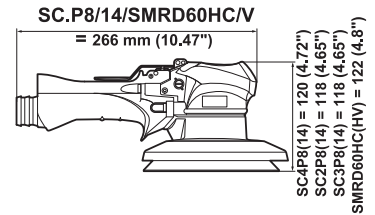
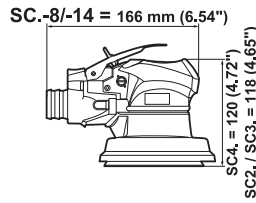
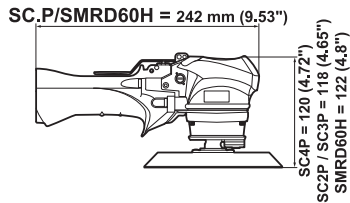
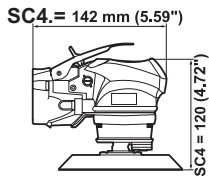

SC4.. / SC..P / SMRD60..

ACCESSORIES INCLUDED

	PART NO.
• 1/4" air hose nipple for 8mm (5/32") ID hose	615 704 019 0
• Clamping lever	615 595 202 0
• Complete dust extraction kit for version (SC.-14/SRMD60HV)	615 399 471 0

Pads:
Thread 5/16" - 24

- Pad ϕ 110mm (4-3/8") - SC2P/8/14
- Pad ϕ 127mm (5") - SC3P
- Pad ϕ 150mm (6") - SC4(P) - SRMD60H.

For Hook & Loop abrasive	For Hook & Loop abrasive (-8) or (-14) (C) or (V) with holes

- | | |
|---------------|---------------|
| 615 990 102 0 | - |
| 615 990 156 0 | 615 990 157 0 |
| 615 990 154 0 | 615 990 155 0 |

OPTIONAL ACCESSORIES

Pads:
Thread 5/16" - 24

- Pad ϕ 110mm (4-3/8") - SC2P/8/14
- Pad ϕ 127mm (5") - SC3P
- Pad ϕ 150mm (6") - SC4(P) - SRMD60H.

For self-adhesive abrasive	For self-adhesive abrasive (-8) or (-14) (C) or (V)

- | | |
|---------------|---------------|
| 615 990 101 0 | - |
| 615 990 111 0 | 615 990 110 0 |
| 615 990 119 0 | 615 990 118 0 |

PAD DIMENSIONS

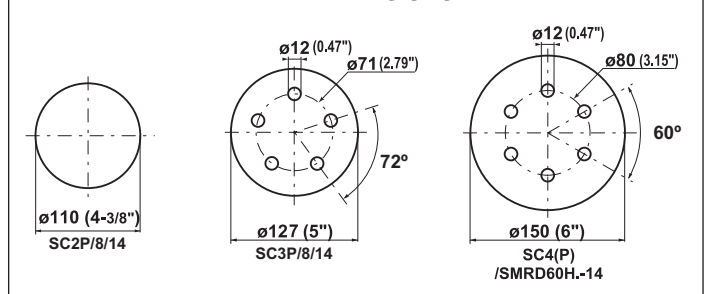

Random orbital sanders for abrasive discs

Ø 110mm (4-3/8") - Ø 127mm (5") - Ø 150mm (6")

375 Watts (0.5 hp) - 10000 rpm

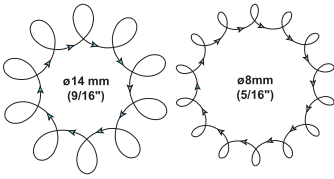

SC4



SC4P



SC4-8



SC4P8 - SMRD60HC



SMRD60H



SC4P14 - SMRD60HV

Caution: comply with the speeds recommended by component and abrasive manufacturers.

PAD SIZE		MODEL	PART NUMBER	MODEL	PART NUMBER	MODEL	PART NUMBER	WEIGHT		AIR CONSUMPTION AT MAX. OUTPUT		AIR INLET THREAD	HOSE INT. Ø	
mm	in.							kg	lb.	l/s	cfm	in.	mm	in.

SANDERS WITH PALM GRIP, ORBIT Ø 8mm (5/16")

		Non-vacuum		External vacuum		Self vacuum									
Ø 150	6	SC4	615 170 081 0	SC4-8	615 170 093 0	SC4-14	615 170 087 0	1.3	2.86	11	23	1/4	8	5/16	

SANDERS WITH HANDLE GRIP, ORBIT Ø 8mm (5/16")

		Non-vacuum		External vacuum		Self vacuum									
Ø 110	4-3/8	SC2P	615 170 077 0	SC2P8	615 170 089 0	SC2P14	615 170 083 0	1.2	2.64	11	23	1/4	8	5/16	
Ø 127	5	SC3P	615 170 079 0	SC3P8	615 170 091 0	SC3P14	615 170 085 0	1.3	2.86	11	23	1/4	8	5/16	
Ø 150	6	SC4P	615 170 078 0	SC4P8	615 170 090 0	SC4P14	615 170 084 0	1.4	3.08	11	23	1/4	8	5/16	

LARGE ORBIT SANDERS WITH HANDLE GRIP, ORBIT Ø 14mm (9/16")

		Non-vacuum		External vacuum		Self vacuum									
Ø 150	6	SMRD60H	615 170 280 0	SMRD60HC	615 170 281 0	SMRD60HV	615 170 282 0	1.3	2.86	11	23	1/4	8	5/16	

Accessories

SV3 = 142mm (5.59")

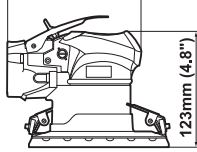

SV.P = 242 mm (9.53")

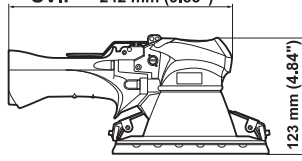

SV.-8/-14 = 166 mm (6.54")

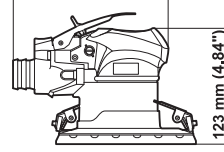

SV.P8/14 = 266 mm (10.47")

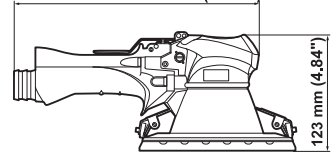

Hose 2.5m long
32mm ID

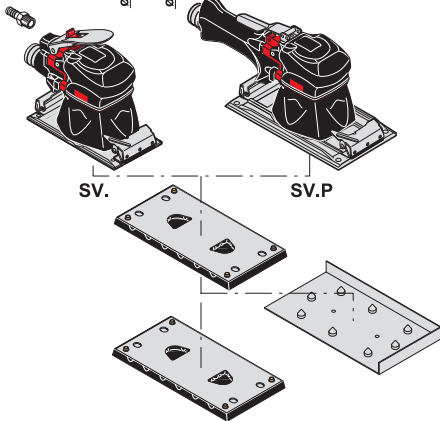
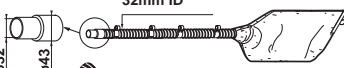

SV.. / SV..P

ACCESSORIES INCLUDED

- 1/4" air hose nipple for 8mm (5/16") ID hose
- Complete dust extraction kit for version (-14)

PART NO.

615 704 019 0
615 399 471 0

Pads and Drilling Plate

- Pad 170x93mm (6-5/8" x 3-5/8") - SV3(P)
- Pad 215x113mm (8-1/2" x 4-1/2") - SV4P

Pad	Drilling plate for release (-8) or (-14)
615 350 018 0	615 990 094 0
615 350 019 0	615 990 095 0

OPTIONAL ACCESSORY

- Pad 170x93mm (6-5/8" x 3-5/8") - 8 side holes SV3(P)

PART NO.

615 350 057 0

8 side holes

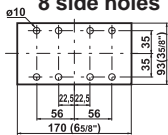

PAD DIMENSIONS

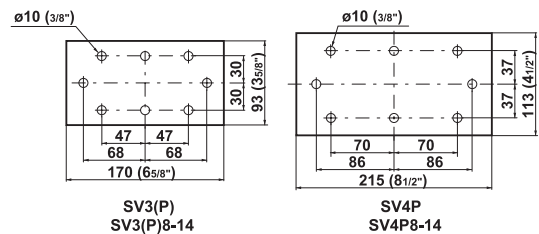

Orbital sanders for abrasive sheets

170 x 93mm (6-5/8"x 3-5/8") - 215 x 113mm (8-1/2"x 4-1/2")

375 Watts (0.5 hp) - 8000 rpm



Caution: comply with the speeds recommended by component and abrasive manufacturers.

PAD SIZE		MODEL	PART NUMBER	MODEL	PART NUMBER	MODEL	PART NUMBER	WEIGHT		AIR CONSUMPTION AT MAX. OUTPUT		AIR INLET THREAD	HOSE INT. Ø	
mm	in.							kg	lb.	l/s	cfm	in.	mm	in.

SANDERS WITH PALM GRIP, ORBIT Ø 5mm (3/16")

		Non-vacuum		External vacuum		Self vacuum									
170x93	65/8 x 35/8	SV3	615 170 066 0	SV3-8	615 170 074 0	SV3-14	615 170 070 0	1.7	3.74	11	23	1/4	8	5/16	

SANDERS WITH HANDLE GRIP, ORBIT Ø 5mm (3/16")

		Non-vacuum		External vacuum		Self vacuum									
170x93	65/8 x 35/8	SV3P	615 170 067 0	SV3P8	615 170 075 0	SV3P14	615 170 071 0	1.8	3.96	11	23	1/4	8	5/16	
215x113	81/2 x 41/2	SV4P	615 170 068 0	SV4P8	615 170 076 0	SV4P14	615 170 072 0	1.9	4.19	11	23	1/4	8	5/16	

Accessories

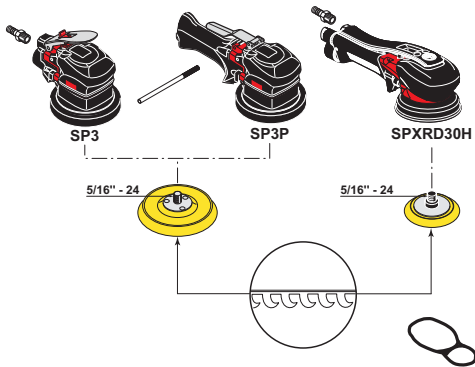
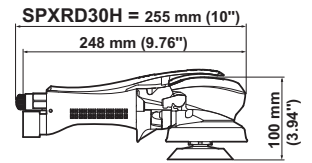
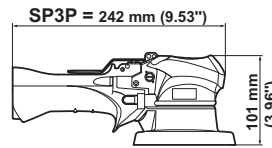
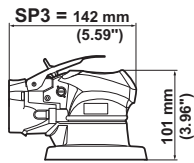

SP3 / SP3P / SPXRD30H

ACCESSORIES INCLUDED

	SP3/SP3P	SPXRD30H
• 1/4" air hose nipple for 8mm (5/16") ID hose	615 704 019 0	615 705 009 0
• 1/4" air hose nipple for 6mm (1/4") ID hose		
• Clamping lever	615 595 202 0	
• Small grip (medium-size grip fitted on sander)		615 303 109 0
• Bail hook		615 571 060 0
Pads: Thread 5/16" - 24		For Hook & Loop abrasive
• Pad \varnothing 127mm (5") for SP3 / SP3P		615 990 123 0
• Pad \varnothing 76mm (3") for SPXRD30H		615 990 178 0

OPTIONAL ACCESSORIES

	SPXRD30H
• Pad cooling kit	615 397 037 0

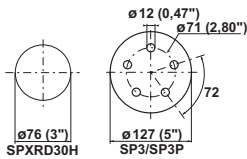

Random orbital polishers

Ø 76mm (3") - Ø 127mm (5")

210 and 375 Watts (0.3 and 0.5 hp) - 10000 and 12000 rpm

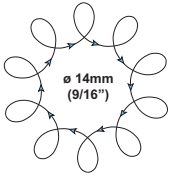

SP3



SP3P



SPXRD30H

Caution: comply with the speeds recommended by component and abrasive manufacturers.

PAD SIZE		MODEL	PART NUMBER	WEIGHT		AIR CONSUMPTION AT MAX. OUTPUT		AIR INLET THREAD	HOSE INT. Ø	
mm	in.			kg	lb.	l/s	cfm	in.	mm	in.
POLISHER WITH PALM GRIP, ORBIT Ø 14mm (9/16")										
Non-vacuum										
Ø 127	5	SP3	615 170 198 0	1.2	2.64	11	23	1/4	8	5/16
POLISHER WITH HANDLE GRIP, ORBIT Ø 14mm (9/16")										
Non-vacuum										
Ø 76	3	SPXRD30H	615 170 332 0	0.9	1.98	11	23	1/4	8	5/16
Ø 127	5	SP3P	615 170 197 0	1.3	2.86	11	23	1/4	8	5/16

Belt sanders

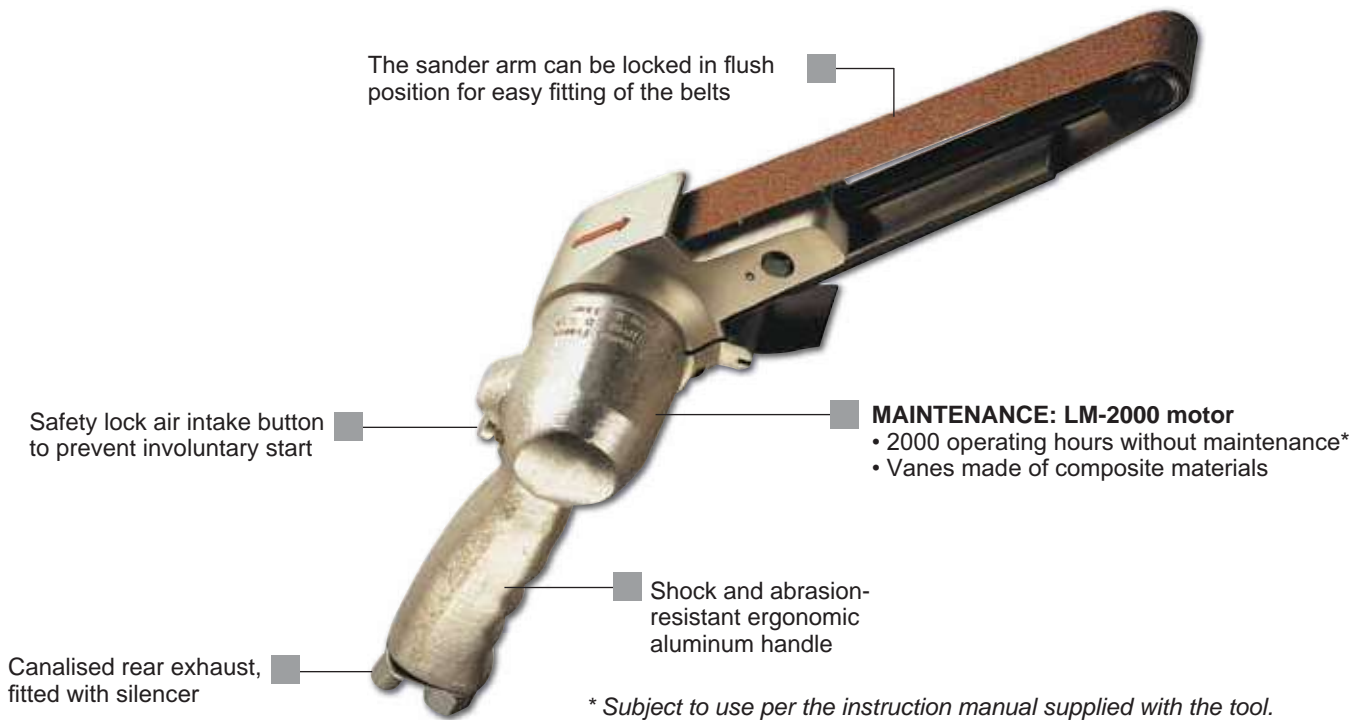

Accessories

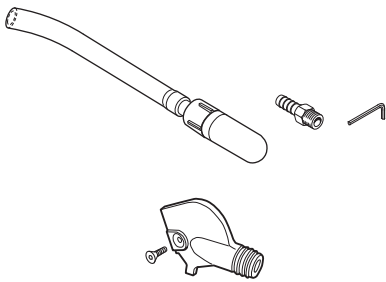
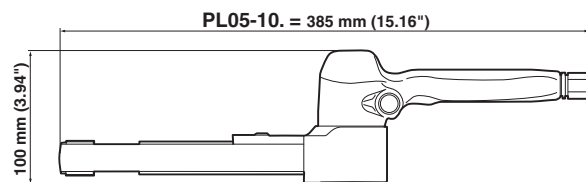

PL05-10D / PL05-10E / PL05-10F

ACCESSORIES INCLUDED

	PART NO.
• Exhaust hose	615 396 022 0
• 1/4" air hose nipple for 6mm (1/4") ID hose	615 705 009 0
• Hex. key 4 mm	615 802 054 0

OPTIONAL ACCESSORIES

	PART NO.
• Suction cap for 32mm (1-1/4") ID vacuum hose	321003
• Screw FHc M4x10	615 616 118 0

OPTIONAL ACCESSORIES

COATED ABRASIVE BELTS

	L x l		GRIT NUMBER			
	mm	in.	P40	P60	P80	P100
480 x 16	18-7/8"	x 5/8	615 811 217 0	615 811 218 0	615 811 219 0	615 811 220 0
480 x 20	18-7/8"	x 25/32	615 811 223 0	615 811 224 0	615 811 225 0	615 811 226 0
480 x 25	18-7/8"	x 63/64	615 811 230 0	615 811 231 0	615 811 232 0	615 811 233 0

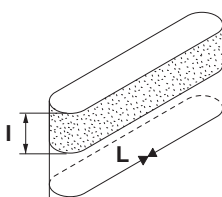

	L x l		GRIT NUMBER			
	mm	in.	P120	P150	P180	P240
480 x 16	18-7/8"	x 5/8	615 811 221 0	615 811 222 0		
480 x 20	18-7/8"	x 25/32	615 811 227 0	615 811 228 0	615 811 229 0	
480 x 25	18-7/8"	x 63/64	615 811 234 0	615 811 235 0	615 811 236 0	615 811 237 0

Belt sanders

300 Watts (0.4 hp) - 16000 rpm



A



B



C



Caution: comply with the speeds recommended by component and abrasive manufacturers.

PIC REF	MODEL	PART NUMBER	FREE SPEED	BELT SIZE L x l		POWER		WEIGHT		AIR CONSUMPTION AT FREE SPEED		AIR INLET THREAD	HOSE INT. Ø	
			rpm	mm	in.	W	hp	kg	lb	l/s	cfm	in.	mm	in.
A	PL05-10D	615 170 131 0	16000	480 x 16	18-7/8 x 5/8	300	0.4	1.2	2.6	12	25.4	1/4	6	1/4
B	PL05-10E	615 170 132 0	16000	480 x 20	18-7/8 x 25/32	300	0.4	1.2	2.6	12	25.4	1/4	6	1/4
C	PL05-10F	615 170 133 0	16000	480 x 25	18-7/8 x 63/64	300	0.4	1.2	2.6	12	25.4	1/4	6	1/4

AFD Applications

Ease of Integration into Machine or Process

- Extensive range of mounting clamps
- Control interfaces to link AFD(E) to other equipment through pneumatics or electrically
- Single signal required for AFD(E) to perform cycle
- Output signals at datum and depth
- Electric motor mounting on 200, 400 and 600 series can be rotated 180°

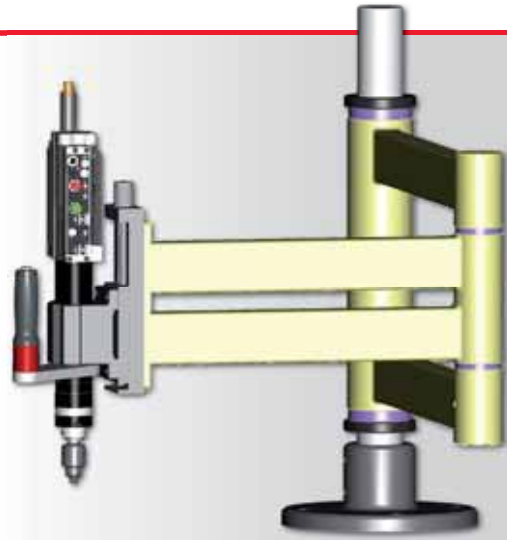

Comprehensive range of Product

- For single spindle operations to multi spindle processes
- Pneumatic and electric drive from 0.22 to 1.1kW (0.3 to 1.47hp) with thrusts up to 1735N (390lbf)
- Reliability through quality

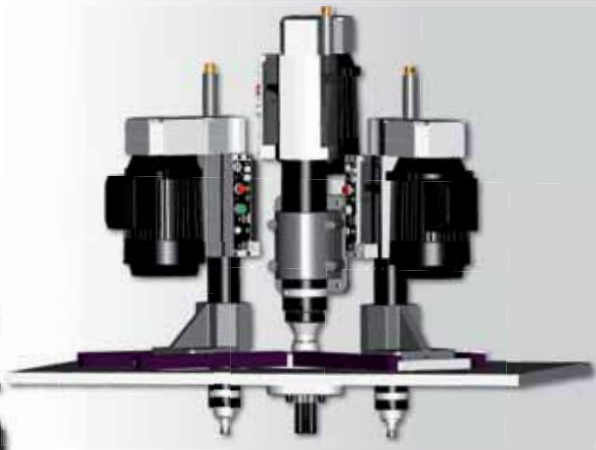

Modular Design

- Flexibility of unit function and speed
- Common components in different models reduce inventory
- Multiple spindle head options
- Drilling and tapping options for all models

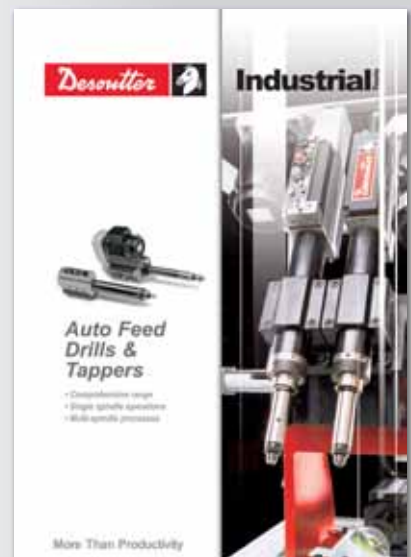

For further information
see the AFD catalogue

More than 1500 different versions

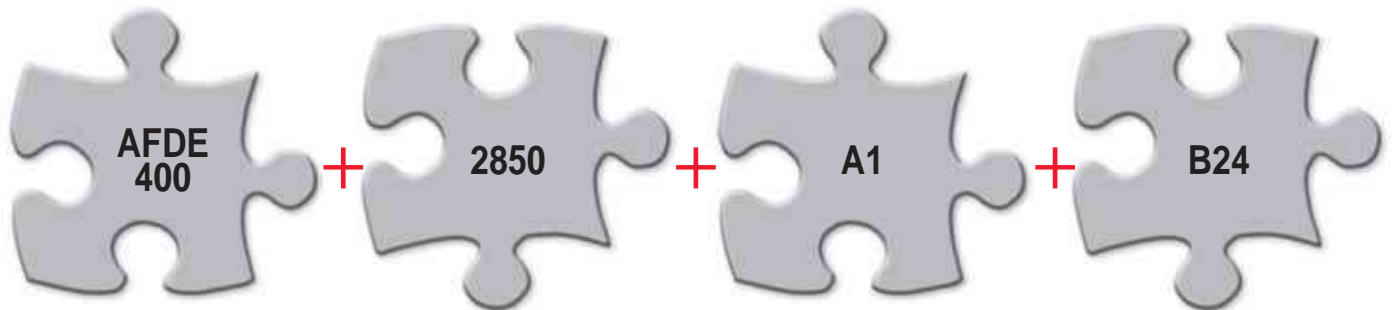

Model Type

Pneumatic Feed and Drive

AFD205 0.22kW (0.30hp)
AFD215 0.22kW (0.30hp)
AFD415 0.38kW (0.51hp)
AFD625 0.61 kW (0.82hp)

Pneumatic Feed, Electric Drive

AFDE200 0.25kW (0.34hp)
AFDE400 0.33kW (0.44hp)
AFDE410 0.75kW (1.00hp)
AFDE610 0.75kW (1.00hp)
AFDE620 1.10kW (1.50hp)

Electric Feed and Drive via Leadscrew

AFTE480 0.75kW (1.00hp)

No Load Speed

The free output speed of the drill or tapper with no drilling or tapping load applied.

Control Block

A1 – Full feature type⁽¹⁾
– Automatic cycle

A6 – Simple type⁽¹⁾
– Remote cycle control

Control block AFTE
– Leadscrew type - PNP
– Leadscrew type - NPN

Output Spindle

Code Output type

- Chuck
- Collet (up to 8mm (5/16"))
- Preset Tooling DIN55058
- 6.5mm (1/4") & 8mm (5/16") Tapping Gearbox
- B16 Taper
- Jacobs No1 & No2
- ISO30 Taper
- Multi Head / Tapping
- Gearbox Adaptor
- High Speed Gearbox



+ OPTIONAL

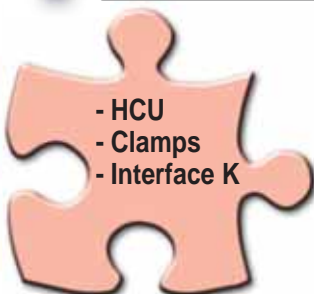

- HCU
- Clamps
- Interface K

(1) Not required on AFTE models.



Air Motors

Advantages

Air motors are versatile power sources which can be used to power many kinds of operations requiring a rotational drive. They have many advantages over electric motors, and often become the only feasible method of operation.



LARGE CHOICE OF POTENTIAL CUSTOMERS



Textile



Marine



Petrochemical



Food Processing



Agricultural Equipment



Printing Machinery



Chemical



Strapping Machinery

Desoutter offers a wide range of rotating vane air motors in **stainless steel** and **lubrication free** versions, with power ranging from 0.16 KW (0.22 hp) to 2.9 KW (3.9 hp). Most motors can be supplied as either undirectional with a threaded shaft or reversible with a keyed shaft. Alternative output options are also available.

Desoutter air motors can also be **Atex certified** for environments with potentially explosive atmospheres.

Air motors are an ideal solution for many applications in such varied equipment as material handling, packaging, strapping or printing machinery, petrochemical and agricultural equipment, food processing machinery, and many more custom and standard machines.

Air motors offer many advantages over electric motors, and are often the only feasible option for driving.

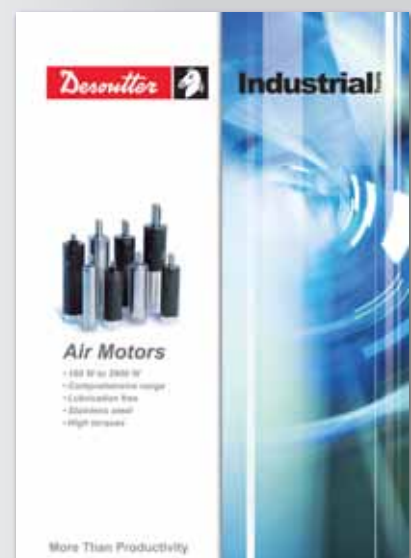

For further information see the Air motors catalogue

ATEX available
 II 2G T4 IIC D110°C or II 2G T5 IIC D85°C
 or II 2G c IIC T6



		<p>M16-KL, M16-KSL Series 0.16 KW (0.22 hp) Maximum torque, 7 Nm (5.1 ft.lb) Keyed shaft Standard and stainless steel Reversible and non reversible</p>
		<p>M25-KL / TL, M25-KSL Series 0.25 KW (0.34 hp) Maximum torque, 17 Nm (12.5 ft.lb) Keyed shaft, threaded shaft Standard and stainless steel Reversible and non reversible</p>
		<p>M39-KL / TL, M39-KSL Series 0.39 KW (0.52 hp) Maximum torque, 26.8 Nm (19.8 ft.lb) Keyed shaft, threaded shaft Standard and stainless steel Reversible and non reversible</p>
		<p>M84-K Series 0.84 KW (1.13 hp) Maximum torque, 490 Nm (360 ft.lb) Keyed shaft Reversible and non reversible</p>
		<p>2H410 Series 0.66 KW (0.85 hp) Maximum torque, 102 Nm (75.2 ft.lb) Worm drive motors</p>
		<p>M180 Series 1.83 KW (2.45 hp) Maximum torque, 333 Nm (245 ft.lb) Reversible and non reversible</p>
		<p>M290 Series 2.91 KW (3.90 hp) Maximum torque, 471 Nm (347 ft.lb) Reversible and non reversible</p>



Accessories

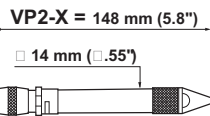

VP2-X

ACCESSORIES INCLUDED

ITEM	PART NO.
• Air Hose - 3.2mm bore - Length 2m (78.7") - 1/8" - 1/4" BSP	75902
• Tungsten carbide tipped needle	63213
• Key	63533

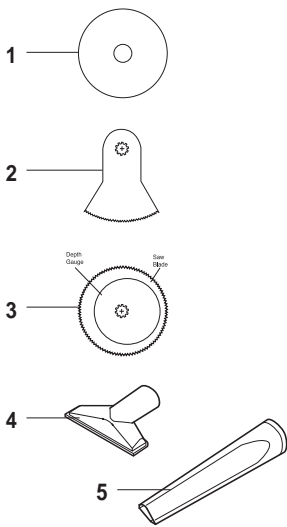

D144-T-.. / S144-T-.. / D170-L / AV101

ACCESSORIES INCLUDED

ITEM	APPLICATION	PART NO.			
		D144-T	S144-T	D170-L	AV101
• Exhaust hose		222453		222453	
• Exhaust Hose Clip		235203		235203	
• Spindle Wrench		164433		15533	
• Clamp Nut Wrench		29443			
• Guard Nut Wrench		29653			
• Hex. Key - 4mm (5/32") A/F		204903		204903	
1 Saw Blade - diamond coated 64mm (2.5") dia.	Fibreglass	32732			
1 Saw Blade - 80 teeth 45mm (1.77") dia.	Soft Steel <1.2mm (3/64")		76362		
1 Saw Blade 64mm (2.5") dia.	Plastics			90762	
1 Saw Blade - teflon coated 64mm (2.5") dia.	Plastics			90772	
2 Saw Blade 50.8mm (2") radius x 50mm (1.97") wide	Soft Wood			90832	
3 Depth Gauge				27262	
4 Upholstery Nozzle					106443
5 Crevice Nozzle					106533

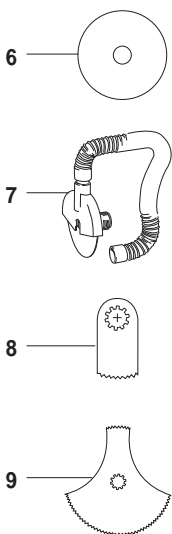

OPTIONAL ACCESSORIES

ITEM	APPLICATION	PART NO.		
		D144-T	S144-T	D170-L
6 Saw Blade 64mm (2.5") dia.	Wood	34252		
6 Saw Blade 50mm (1.97") dia.	Soft Steel >1.2mm (3/64") max depth 7mm		76372	
6 Saw Blade 50mm (1.97") dia.	Hard Steel <1.2mm (3/64") max depth 10mm (3/8")		76382	
6 Saw Blade 50mm (1.97") dia.	Aluminium max depth 10mm (3/8")		76392	
7 Dust Extraction Hood includes 2m hose - 32mm (1.26") ID				78472
6 Saw Blade - diamond tipped 64mm (2.5") dia.	Fibreglass			16962
6 Saw Blade - diamond tipped 1.2mm (3/64") tooth pitch - 64mm (2.5") dia.	Fibreglass			90722
6 Saw Blade - diamond tipped 1.2mm (3/64") tooth pitch - 80mm (3.15") dia.	Fibreglass			90732
6 Saw Blade - 1.5mm (0.06") tooth pitch 51mm (2") dia.	Soft Wood			90782
6 Saw Blade - 1.8mm (0.07") tooth pitch 64mm (2.5") dia.	Soft Wood			90792
6 Saw Blade - 1.5mm (0.06") tooth pitch 76mm (3") dia.	Soft Wood			90802
8 Saw Blade 22mm (0.87") radius x 15mm (19/32") wide	Soft Wood			90822
9 Saw Blade 63.5mm (2.5") dia. 60mm (2.36") + 16mm (5/8") segments	Soft Wood			90842

Miscellaneous



A



B



C



D



E



F

PIC REF	MODEL	PART NUMBER	BLOWS PER MINUTE		WEIGHT		AIR CONSUMPTION AT FREE SPEED		AIR INLET THREAD		HOSE INT. Ø	
			Blows/min		kg	lb.	l/s	cfm	in.	mm	in.	
AIR SCRIBE												
A	VP2-X	671094	11400		0.1	0.2	0.9	1.9	1/8	3.2	1/8	

PIC REF	MODEL	PART NUMBER	FREE SPEED	OSCILLATING FREQUENCY	BLADE Ø		WEIGHT		LENGTH		AIR CONSUMPTION		AIR INLET THREAD	HOSE INT. Ø	
			rpm	c/min	mm	in.	kg	lb.	mm	in.	l/s	cfm	in.	mm	in.
FIBREGLASS SAW - capacity 13mm (1/2") depth															
B	D144-T-3300	1273234	3300		64	2.5	0.9	2.0	229	9.01	9.4	19.9	1/4 BSP	10	3/8
CIRCULAR SAW - capacity 10mm (3/8") depth (hard steel 1.2mm (3/64") depth)															
C	S144-T-3100	936974	3100	-	45	1.77	1.4	3.1	245	9.65	9.4	19.9	1/4 BSP	10	3/8
OSCILLATING SAW															
D	D170-L	1261574	-	19000	80	3.2	0.9	2.0	287	11.30	9.3	19.7	1/4 BSP	10	3/8
VACUUM CLEANER															
E	AV101	128534	-	-	-	-	0.7	1.54	202	7.95	5.9	12.5	1/4 BSP	6	1/4
VACUUM PEN															
F	V100	129504	-	-	-	-	0.45	0.99	137	5.39	0.7	0.33	3.6 Spline	4	5/32



Air Line Network

Desoutter Air Line Accessories are specially developed to be used with Desoutter Tools & Equipments

Desoutter Airline Accessories can also be used with other pneumatic products

All accessories can be used for other applications with any pneumatic equipments



When developing the Desoutter Air Line Accessories range, we have focused on Performance, Quality, Ergonomics and Safety. Based on this, we now offer a wide range of accessories for optimal air line installation.

Our accessories enable to reach higher productivity with lower energy consumption, a sustainable reduction of energy costs and an extended lifetime of your tools

Performance

In order to get the best performance out of your air line installation it is key to supply air at a constant pressure (6.3 bar) This, together with minimizing the pressure drop, is the primary focus when designing the Desoutter couplings, hoses and FRLs

The result is not only a better performance in terms of a reduction of energy costs but also in a better lifetime of the tools

Ergonomics and Safety

To further improve the comfort of use for our customers we now offer hoses in our EFFI line with lower weight and more flexible. In combination with Easy Flow, Safety couplings, Airflex and high quality balancers you can build up a workplace where the operators' safety and ergonomics are in focus

Quality

All our products are developed to perform in industrial applications. Desoutter Accessories are made with the highest quality materials to ensure the best possible performance and lifetime of the tools

Air Line Network

Desoutter Air Preparation Units are designed to help you get maximum performance from your tools. They ensure minimal pressure drop and thus minimum energy losses in the air distribution system, benefiting the environment and cutting your operating costs. The lifetimes of your tools will be extended by using air preparation units and with that comes lower repair costs and less downtime. A correct air installation guarantees productivity and good total economy.

Air dryers and filters can cause a 0.2 - 0.3 bar (3-4 psi) pressure drop. However, for many applications these may be essential.

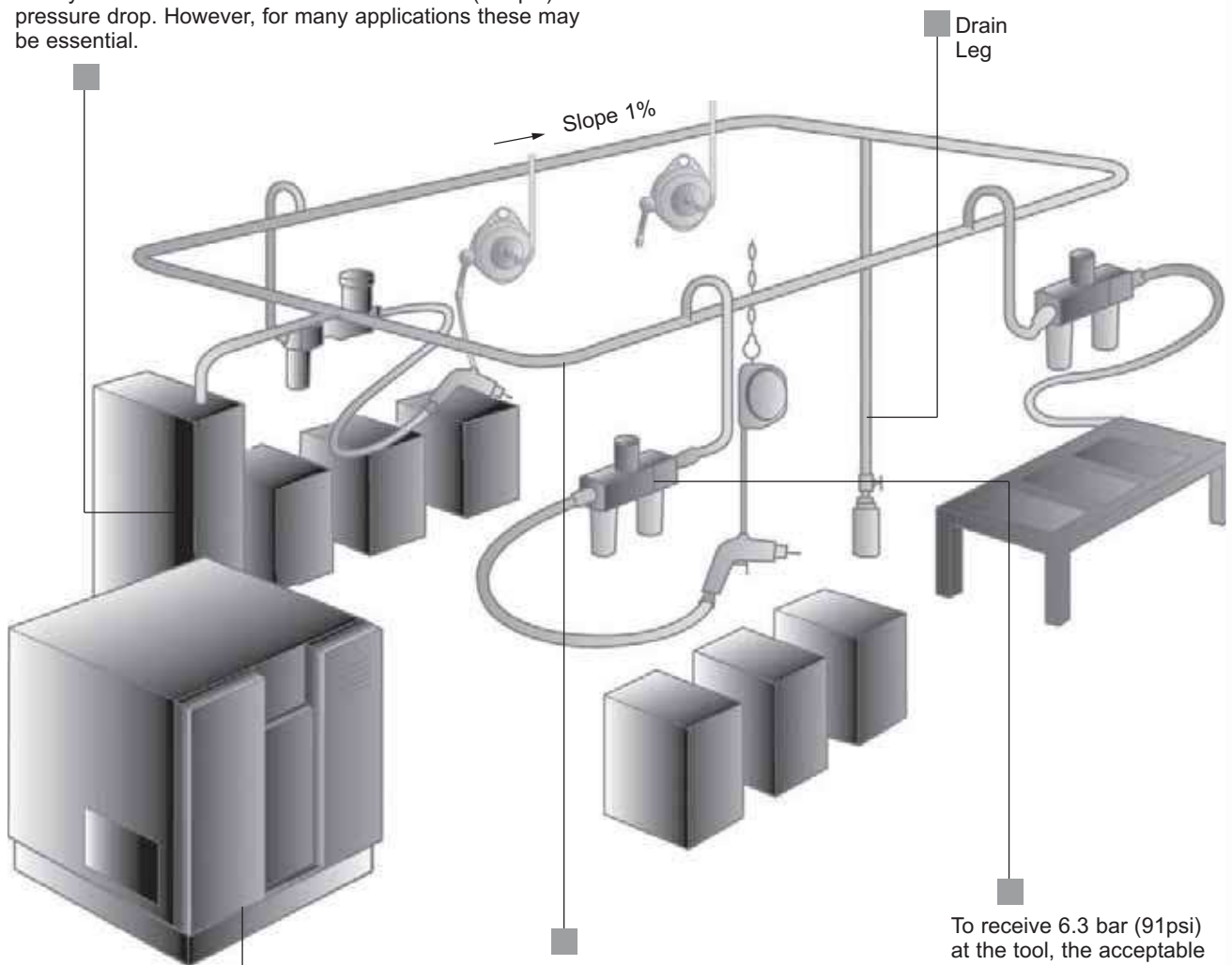

A normal compressor can deliver up to 7.5 bar (109 psi) air line pressure, depending on start and stop settings.

A carefully designed network virtually eliminates pressure drop. We recommend a Ring Main layout which has a slope away from the input of 1%.

To receive 6.3 bar (91psi) at the tool, the acceptable maximum pressure drop from airline accessories is 0.6 bar (9 psi). A combination of high performance components and careful engineering will achieve this.

Selection Guide

CONNECTION: BSP + EASY FLOW EURO SERIES COUPLINGS/NIPPLES



KITS GUIDE	TOOL MODEL	FRL KIT PART NO.	HOSE KIT PART NO.	HOSE WHIP PART NO.	AIR FLEX PART NO.	CLOSED HOSE REEL KIT PART NO.	OPEN HOSE REEL KIT PART NO.
SCREWDRIVERS							
	SB..A/SBP/SCBP	615 398 036 5	615 398 055 5		615 804 746 0	615 398 049 5	615 398 068 5
	SB..LR/SCP/SCPT	615 398 036 5	615 398 055 5		615 804 746 0	615 398 049 5	615 398 068 5
	SC2	615 398 036 5	615 398 055 5		615 804 746 0	615 398 049 5	615 398 068 5
	SD/SDP/SDT/2D4872	615 398 037 5	615 398 056 5		615 804 746 0	615 398 050 5	615 398 069 5
	SH70	615 398 037 5	615 398 056 5		615 804 746 0	615 398 050 5	615 398 069 5
	SH150/200/280	615 398 037 5	615 398 056 5		615 804 746 0	615 398 050 5	615 398 069 5
	SH420/500/700/850	615 398 037 5	615 398 056 5		615 804 746 0		615 398 069 5
	SH1200/2000	615 398 038 5	615 398 058 5		615 804 750 0		
	SH150/200/280	615 398 037 5	615 398 056 5		615 804 746 0	615 398 050 5	615 398 069 5
	H410	615 398 037 5	615 398 057 5		615 804 748 0		
	PT010 to 125	615 398 037 5	615 398 056 5		615 804 746 0	615 398 069 5	
	PT160 to 450	615 398 037 5	615 398 057 5		615 804 748 0		
	PTF012 to 040	615 398 037 5	615 398 056 5		615 804 746 0	615 398 050 5	615 398 069 5
PTF035 to 172	615 398 037 5	615 398 057 5		615 804 748 0	615 398 069 5		
GRINDERS							
	KC1600	615 398 036 5	615 398 055 5		615 804 746 0	615 398 049 5	615 398 068 5
	KC061000	615 398 037 5	615 398 056 5		615 804 746 0	615 398 050 5	615 398 069 5
	K3../KC3../KA3..	615 398 037 5	615 398 056 5		615 804 746 0	615 398 050 5	615 398 069 5
	K6../K9../KC6../KC9../KA6..	615 398 037 5	615 398 057 5		615 804 748 0		
	KA16..	615 398 038 5	615 398 058 5	615 398 044 5	615 804 748 0		
AIR SCRIBE							
	VP2X	615 398 036 5	615 398 055 5		615 804 746 0	615 398 049 5	615 398 068 5
SANDERS							
	05X/KC1600	615 398 037 5	615 398 057 5		615 804 748 0		
	KA3../DA6.35/DA8.20	615 398 037 5	615 398 056 5		615 804 746 0	615 398 050 5	615 398 069 5
	KA16..	615 398 038 5	615 398 058 5	615 398 044 5	615 804 748 0		
	KL1120	615 398 037 5	615 398 057 5	615 804 748 0			
	KL165/KA26	615 398 038 5	615 398 058 5	615 398 045 5	615 804 750 0		
	SX../PL05	615 398 037 5	615 398 056 5		615 804 746 0	615 398 050 5	615 398 069 5
SC../SMRD60../SV../SP..	615 398 037 5	615 398 056 5		615 804 746 0	615 398 050 5	615 398 069 5	
RIVETERS							
	CP4444/CP4450	615 398 037 5	615 398 056 5		615 804 746 0	615 398 050 5	615 398 069 5
	CP4475	615 398 037 5	615 398 056 5		615 804 746 0	615 398 050 5	615 398 069 5
DRILLS							
	DR350/DR300	615 398 037 5	615 398 056 5		615 804 746 0	615 398 050 5	615 398 069 5
	DR500/DR750	615 398 037 5	615 398 056 5		615 804 746 0		615 398 069 5
	D16/2F16/2H16	615 398 037 5	615 398 056 5		615 804 746 0		615 398 069 5
	D156	615 398 037 5	615 398 056 5		615 804 746 0	615 398 050 5	615 398 069 5
	RFD(T)/CFD	615 398 037 5	615 398 056 5		615 804 746 0		615 398 069 5
	C27	615 398 036 5	615 398 055 5		615 804 746 0	615 398 049 5	615 398 068 5

Selection Guide

CONNECTION: BSP + EASY FLOW EURO SERIES COUPLINGS/NIPPLES



KIT DESCRIPTION	PART NUMBER	KIT CONTENT
FRL KIT		
	615 398 036 5	1/4" BSP Ball valve + 2 Stage 1/4" FRL + 1/4" EF Coupling EURO 7,6mm
	615 398 037 5	1/2" BSP Ball valve + 2 Stage 1/2" FRL + 1/2" EF Coupling EURO 7,6mm
	615 398 038 5	3/4" BSP Ball valve + 2 Stage 3/4" FRL + 3/4" EF Coupling EURO 10,4mm
HOSE KIT		
	615 398 055 5	Hose Kit: 1/4" EF Nipple EURO 7,6mm + 8m 1/4" Polyuretane hose + EF Coupling EURO 7,6mm Nipple's kit for tool 1/4" & 1/8"
	615 398 056 5	Hose Kit: 1/4" EF Nipple EURO 7,6mm + 8m 3/8" Polyuretane hose + EF Coupling EURO 7,6mm Nipple's kit for 1/4" & 1/8" tool inlet
	615 398 057 5	Hose Kit: 3/8" EF Nipple EURO 7,6mm + 8m 1/2" Polyuretane hose + EF Coupling EURO 7,6mm Nipple's kit for 3/8" tool inlet
	615 398 058 5	Hose Kit: 1/2" EF Nipple EURO 10,4mm + 8m 5/8" Polyuretane hose + EF Coupling EURO 10,4mm Nipple's kit for 3/8" & 1/2" tool inlet
	615 398 059 5	Hose Kit: 1/2" EF Nipple EURO 10,4mm + 8m 1" Polyuretane hose + EF Coupling EURO 10,4mm Nipple's kit for 1/2" & 1" tool inlet
HOSE WHIP KIT		
	615 398 044 5	Rubber hose whip 3/8" BSP 13mm ID + EF Nipple EURO 10,4mm
	615 398 045 5	Rubber hose whip 1/2" BSP 16mm ID + EF Nipple EURO 10,4mm
CLOSED HOSE REEL KIT		
	615 398 049 5	HRS Polyurethane Hose Reel 8mm ID, 10m length + EF Nipple and Coupling EURO 7,6mm
	615 398 050 5	HRM Polyurethane Hose Reel 10mm ID, 10m length + EF Nipple and Coupling EURO 7,6mm
OPEN HOSE REEL KIT		
	615 398 068 5	HROM Polyurethane Hose Reel 10mm ID, 16m length + EF Nipple and Coupling EURO 7,6mm
	615 398 069 5	HROL Polyurethane Hose Reel 13mm ID, 16m length + EF Nipple and Coupling EURO 7,6mm

Selection Guide

CONNECTION: NPT + EASY FLOW ISO 6150B MIL-C4109 COUPLINGS/NIPPLES



KITS GUIDE	TOOL MODEL	FRL KIT PART NO.	HOSE KIT PART NO.	HOSE WHIP PART NO.	AIR FLEX PART NO.	CLOSED HOSE REEL KIT PART NO.	OPEN HOSE REEL KIT PART NO.
SCREWDRIVERS							
	SB..A/SBP/SCBP	615 398 039 5	615 398 059 5		615 804 746 0	615 398 0515	615 398 070 5
	SB..LR/SCP/SCPT	615 398 039 5	615 398 059 5		615 804 746 0	615 398 0515	615 398 070 5
	SC2	615 398 039 5	615 398 059 5		615 804 746 0	615 398 0515	615 398 070 5
	SD/SDP/SDT/2D4872	615 398 040 5	615 398 060 5		615 804 746 0	615 398 052 5	615 398 071 5
	SH70	615 398 040 5	615 398 060 5		615 804 746 0	615 398 052 5	615 398 071 5
	SH150/200/280	615 398 040 5	615 398 060 5		615 804 746 0	615 398 052 5	615 398 071 5
	SH420/500/700/850	615 398 040 5	615 398 060 5		615 804 746 0		615 398 071 5
	SH1200/2000	615 398 041 5	615 398 062 5		615 804 7500		
	SH150/200/280	615 398 037 5	615 398 056 5		615 804 746 0	615 398 050 5	615 398 069 5
	H410	615 398 040 5	615 398 061 5		615 804 748 0		
	PT010 to 125	615 398 040 5	615 398 060 5		615 804 746 0		615 398 071 5
	PT160 to 450	615 398 040 5	615 398 061 5		615 804 748 0		
	PTF012 to 040	615 398 040 5	615 398 060 5		615 804 746 0	615 398 052 5	615 398 071 5
PTF035 to 172	615 398 040 5	615 398 061 5		615 804 748 0		615 398 071 5	
GRINDERS							
	KC1600	615 398 039 5	615 398 059 5		615 804 746 0	615 398 0515	615 398 070 5
	KC061000	615 398 040 5	615 398 060 5		615 804 746 0	615 398 052 5	615 398 071 5
	K3../KC3../KA3..	615 398 040 5	615 398 060 5		615 804 746 0	615 398 052 5	615 398 071 5
	K6../K9../KC6../KC9../KA6..	615 398 040 5	615 398 061 5		615 804 748 0		
	KA16..	615 398 041 5	615 398 062 5	615 398 046 5	615 804 748 0		
AIR SCRIBE							
	VP2X	615 398 039 5	615 398 059 5		615 804 746 0	615 398 051 5	615 398 070 5
SANDERS							
	05X/KC1600	615 398 040 5	615 398 061 5		615 804 748 0		
	KA3../DA6.35/DA8.20	615 398 040 5	615 398 060 5		615 804 746 0	615 398 052 5	615 398 071 5
	KA16..	615 398 040 5	615 398 061 5		615 804 748 0		
	KL1120	615 398 041 5	615 398 062 5	615 398 046 5	615 804 748 0		
	KL165/KA26	615 398 041 5	615 398 062 5	615 398 047 5	615 804 750 0		
	SX../PL05	615 398 040 5	615 398 060 5		615 804 746 0	615 398 052 5	615 398 071 5
	SC../SMRD60../SV../SP..	615 398 040 5	615 398 060 5		615 804 746 0	615 398 052 5	615 398 071 5
RIVETERS							
	CP4444/CP4450	615 398 040 5	615 398 060 5		615 804 746 0	615 398 052 5	615 398 071 5
	CP4475	615 398 040 5	615 398 060 5		615 804 746 0	615 398 052 5	615 398 071 5
DRILLS							
	DR350/DR300	615 398 040 5	615 398 060 5		615 804 746 0	615 398 052 5	615 398 071 5
	DR500/DR750	615 398 040 5	615 398 060 5		615 804 746 0		615 398 071 5
	D16/2F16/2H16	615 398 040 5	615 398 060 5		615 804 746 0		615 398 071 5
	D156	615 398 040 5	615 398 060 5		615 804 746 0	615 398 052 5	615 398 071 5
	RFD(T)/CFD	615 398 040 5	615 398 060 5		615 804 746 0		615 398 071 5
	C27	615 398 039 5	615 398 059 5		615 804 746 0	615 398 051 5	615 398 070 5

Selection Guide

CONNECTION: NPT + EASY FLOW ISO 6150B MIL-C4109 COUPLINGS/NIPPLES



KIT DESCRIPTION	PART NUMBER	KIT CONTENT
FRL KIT		
	615 398 039 5	1/4" NPT Ball valve + 2 Stage 1/4" FRL + 1/4" EF Coupling ISO 6150B 8mm
	615 398 040 5	1/2" NPT Ball valve + 2 Stage 1/2" FRL + 1/2" EF Coupling ISO 6150B 8mm
	615 398 041 5	3/4" NPT Ball valve + 2 Stage 3/4" FRL + 3/4" EF Coupling ISO 6150B 11mm
HOSE KIT		
	615 398 059 5	Hose Kit: 1/4" EF Nipple ISO 6150B 8mm + 8m 5/16" Polyuretane hose + EF Coupling ISO 6150B 8mm Nipple's kit for tool 1/4" & 1/8"
	615 398 060 5	Hose Kit: 1/4" EF Nipple ISO 6150B 8mm + 8m 3/8" Polyuretane hose + EF Coupling ISO 6150B 8mm Nipple's kit for 1/4" & 3/8" tool inlet
	615 398 061 5	Hose Kit: 3/8" EF Nipple ISO 6150B 8mm + 8m 1/2" Polyuretane hose + EF Coupling ISO 6150B 8mm Nipple's kit for 3/8" tool inlet
	615 398 062 5	Hose Kit: 1/4" EF Nipple ISO 6150B 8mm + 8m 1/4" Polyuretane hose + EF Coupling ISO 6150B 8mm Nipple's kit for 1/8" tool inlet
	615 398 063 5	Hose Kit: 1/2" EF Nipple ISO 6150B 11mm + 8m 5/8" Polyuretane hose + EF Coupling ISO 6150B 11mm Nipple's kit for 3/8" & 1/2" tool inlet
HOSE WHIP KIT		
	615 398 046 5	Rubber hose whip 3/8" NPT 13mm ID + EF Nipple ISO 6150B 11mm
	615 398 047 5	Rubber hose whip 1/2" NPT 16mm ID + EF Nipple ISO 6150B 11mm
CLOSED HOSE REEL KIT		
	615 398 051 5	HRNS Polyurethane Hose Reel 8mm ID, 10m length + EF Nipple and Coupling ISO 6150B 8mm
	615 398 052 5	HRNM Polyurethane Hose Reel 10mm ID, 10m length + EF Nipple and Coupling ISO 6150B 8mm
OPEN HOSE REEL KIT		
	615 398 070 5	HRNO M Polyurethane Hose Reel 10mm ID, 16m length + EF Nipple and Coupling ISO 6150B 8mm
	615 398 071 5	HRNO L Polyurethane Hose Reel 13mm ID, 16m length + EF Nipple and Coupling ISO 6150B 8mm

Selection Guide

CONNECTION: NPT + EASY FLOW ASIA 7,5MM



KITS GUIDE	TOOL MODEL	FRL KIT PART NO.	HOSE KIT PART NO.	HOSE WHIP PART NO.	AIR FLEX PART NO.	CLOSED HOSE REEL KIT PART NO.	OPEN HOSE REEL KIT PART NO.
SCREWDRIVERS							
	SB..A/SBP/SCBP	615 398 042 5	615 398 064 5		615 804 746 0	615 398 053 5	615 398 072 5
	SB..LR/SCP/SCPT	615 398 036 5	615 398 055 5		615 804 746 0	615 398 049 5	615 398 068 5
	SC2	615 398 042 5	615 398 064 5		615 804 746 0	615 398 053 5	615 398 072 5
	SD/SDP/SDT/2D4872	615 398 043 5	615 398 065 5		615 804 746 0	615 398 054 5	615 398 073 5
	SH70	615 398 043 5	615 398 065 5		615 804 746 0	615 398 054 5	615 398 073 5
	SH150/200/280	615 398 043 5	615 398 065 5		615 804 746 0	615 398 054 5	615 398 073 5
	SH420/500/700/850	615 398 043 5	615 398 065 5		615 804 746 0		615 398 073 5
	SH1200/2000	615 398 041 5	615 398 063 5		615 804 750 0		
	SH150/200/280	615 398 037 5	615 398 056 5		615 804 746 0	615 398 050 5	615 398 069 5
	H410	615 398 043 5	615 398 066 5		615 804 748 0	615 398 053 5	615 398 072 5
	PT010 to 125	615 398 043 5	615 398 065 5		615 804 746 0	615 398 054 5	615 398 073 5
	PT160 to 450	615 398 043 5	615 398 066 5		615 804 748 0	615 398 053 5	615 398 072 5
	PTF012 to 040	615 398 043 5	615 398 065 5		615 804 746 0	615 398 054 5	615 398 073 5
PTF035 to 172	615 398 043 5	615 398 066 5		615 804 748 0			
GRINDERS							
	KC1600	615 398 042 5	615 398 064 5		615 804 746 0	615 398 053 5	615 398 072 5
	KC061000	615 398 043 5	615 398 065 5		615 804 746 0	615 398 054 5	615 398 073 5
	K3../KC3../KA3..	615 398 043 5	615 398 065 5		615 804 746 0	615 398 054 5	615 398 073 5
	K6../K9../KC6../KC9../KA6..	615 398 043 5	615 398 066 5		615 804 748 0		
	KA16..	615 398 041 5	615 398 063 5	615 398 048 5	615 804 748 0		
AIR SCRIBE							
	VP2X	615 398 042 5	615 398 064 5		615 804 746 0	615 398 053 5	615 398 072 5
SANDERS							
	05X/KC1600	615 398 037 5	615 398 057 5		615 804 748 0		
	KA3../DA6.35/DA8.20	615 398 037 5	615 398 056 5		615 804 746 0	615 398 050 5	615 398 069 5
	KA16..	615 398 038 5	615 398 058 5	615 398 044 5	615 804 748 0		
	KL1120	615 398 037 5	615 398 057 5	615 804 748 0			
	KL165/KA26	615 398 038 5	615 398 058 5	615 398 045 5	615 804 750 0		
	SX../PL05	615 398 037 5	615 398 056 5		615 804 746 0	615 398 050 5	615 398 069 5
SC../SMRD60../SV../SP..	615 398 037 5	615 398 056 5		615 804 746 0	615 398 050 5	615 398 069 5	
RIVETERS							
	CP4444/CP4450	615 398 043 5	615 398 065 5		615 804 746 0	615 398 054 5	615 398 0735
	CP4475	615 398 043 5	615 398 065 5		615 804 746 0	615 398 054 5	615 398 0735
DRILLS							
	DR350/DR300	615 398 043 5	615 398 065 5		615 804 746 0	615 398 054 5	615 398 073 5
	DR500/DR750	615 398 043 5	615 398 065 5		615 804 746 0		615 398 073 5
	D16/2F16/2H16	615 398 043 5	615 398 065 5		615 804 746 0		615 398 073 5
	D156	615 398 043 5	615 398 065 5		615 804 746 0	615 398 054 5	615 398 073 5
	RFD(T)/CFD	615 398 043 5	615 398 065 5		615 804 746 0		615 398 073 5
	C27	615 398 042 5	615 398 064 5		615 804 746 0	615 3980 53 5	615 398 072 5

Selection Guide

CONNECTION: NPT + EASY FLOW ASIA 7,5MM



KIT DESCRIPTION	PART NUMBER	KIT CONTENT
FRL KIT		
	615 398 0425	1/4" NPT Ball valve + 2 Stage 1/4" FRL + 1/4" EF Coupling ASIA 7,5mm
	615 398 0435	1/2" NPT Ball valve + 2 Stage 1/2" FRL + 1/2" EF Coupling ASIA 7,5mm
	615 398 0415	3/4" NPT Ball valve + 2 Stage 3/4" FRL + 3/4" EF Coupling ISO 6150B 11mm
HOSE KIT		
	615 398 0645	Hose Kit: 1/4" EF Nipple ASIA 7,5mm + 8m 5/16" Polyuretane hose + EF Coupling ASIA 7,5mm Nipple's ASIA kit for tool 1/4" & 1/8"
	615 3980 655	Hose Kit: 1/4" EF Nipple ASIA 7,5mm + 8m 3/8" Polyuretane hose + EF Coupling ASIA 7,5mm Nipple's ASIA kit for 1/4" & 3/8" tool inlet
	615 398 0665	Hose Kit: 3/8" EF Nipple ASIA 7,5mm + 8m 1/2" Polyuretane hose + EF Coupling ASIA 7,5mm Nipple's ASIA kit for 3/8" tool inlet
	615 398 0635	Hose Kit: 1/2" EF Nipple ASIA 7,5mm + 8m 1/2" Polyuretane hose + EF Coupling ASIA 7,5mm Nipple's ASIA kit for 3/8" tool inlet
	615 398 0675	Hose Kit: 1/2" EF Nipple ISO 6150B 11mm + 8m 5/8" Polyuretane hose + EF Coupling ISO 6150B 11mm Nipple's kit for 3/8" & 1/2" tool inlet
	HOSE WHIP KIT	
	615 398 0485	Rubber hose whip 3/8" NPT 13mm ID + EF Nipple ASIA 7,5mm
	615 398 0475	Rubber hose whip 1/2" NPT 16mm ID + EF Nipple ASIA 7,5mm
CLOSED HOSE REEL KIT		
	615 398 0535	HRNS Polyurethane Hose Reel 8mm ID, 10m length + EF Nipple and Coupling ASIA 7,5mm
	615 398 0545	HRNM Polyurethane Hose Reel 10mm ID, 10m length + EF Nipple and Coupling ASIA 7,5m
OPEN HOSE REEL KIT		
	615 398 0725	HRNO M Polyurethane Hose Reel 10mm ID, 16m length + EF Nipple and Coupling ASIA 7,5mm
	615 398 0735	HRNO L Polyurethane Hose Reel 13mm ID, 16m length + EF Nipple and Coupling ASIA 7,5mm

Air Preparation Units

FILTERS, REGULATORS, LUBRICATORS

Why should you use a filter, regulator and lubricator ?

The use of a filter, regulator and lubricator (in that order) for pretool air preparation is strongly recommended by Desoutter. Proper air preparation will result in improved tool performance and increased tool life. The units should be mounted as close to the tool as possible, preferably right where the tool hose is connected to the system. To realize their full value, these units should be checked on a regular assigned basis by maintenance workers or the operators themselves

AIR FILTER

Filter separates impurities such as water and solid particles

Not using filters in combination with air tools leads to shorter service life, higher maintenance costs and lower efficiency. Old air systems with cool dryers, for instance, generate a lot of rust and running tools without installing a filter could damage the tool in less than a week

Desoutter filters separate up to 98% of the water when operating within their working range. All three types (Small, Medium and Big) are very low pressure drop

REGULATOR

The regulator ensures that the pre-set working pressure remains constant - regardless of pressure variations in the intake air and minor variations in the airflow rate. For example, a pressure of 1 bar higher than necessary results in a 16% increase in air consumption

Spring controlled regulators are quick acting and therefore should be used for all types of air tools.

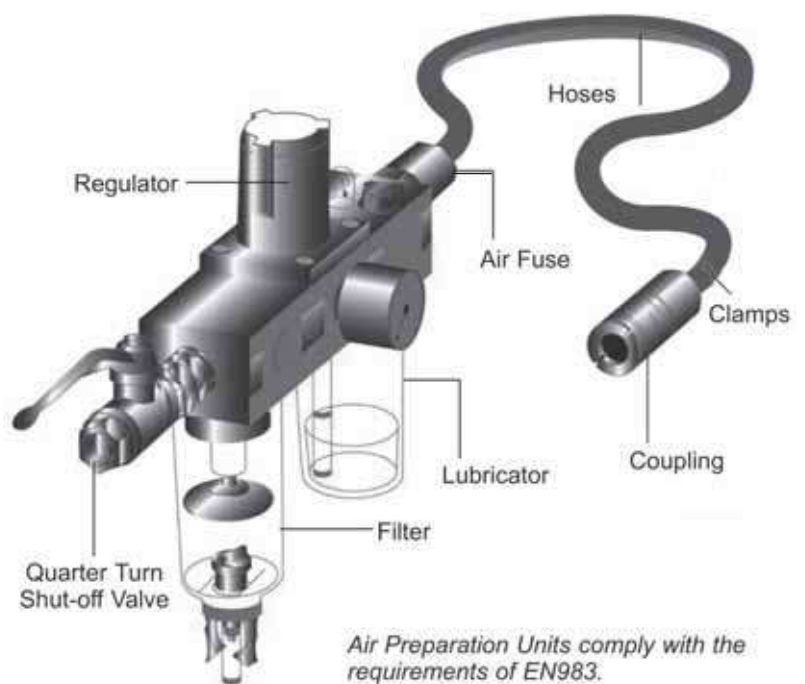

TOOL PRESSURE	AIR CONSUMPTION
91 psi (6 bar)	100 %
101 psi (7 bar)	110 %
116 psi (8 bar)	125 %

LUBRICATORS

If lubricators are not used, tool motor vanes will need to be changed more often. The life of the vanes may decrease to as little as 1/10th of the normal working time. The oil fog lubricator is the most common type of lubricator. It supplies a mist of oil to the air hose

Different types of FRL	Port size in.	Air flows at 6 bars L/S CFM (l/s)
Small units	1/4	Up to 19 (9)
	3/8	Up to 29.7 (14)
Medium units	1/2	Up to 78.4 (37)
Big units	1	Up to 175.9 (83)

Air Preparation Units



FEATURES AND BENEFITS

High air flow capacity: up to 220 cfm (104 l/s) to cover most of the pneumatic tool needs.
Available in kits: 1/4", 1/2", 3/4", BSP or NPT, 2 or 3 stages units or individual units.
Durable design including quick release bayonet metal bowls for rough working environments.

- (1) Liquid level indicator on the bowls for improved reading.
- (2) Filter with 5µm element pre-installed to optimize the air cleaning and with automatic drain valve.
- (3) Supplied with metal pressure gauge 0-10 bar (0-145 PSI) with metric and imperial scales.
- (4) 145 – 245 PSI (10-17 bar) inlet / outlet max. pressure.
- (5) Micro fog lubricator to optimize the air/oil ratio
- (6) Automatic drain valve
- (7) Manual drain

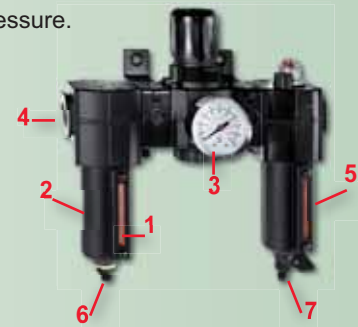

Max air flow Δ 14.5 PSI (1 bar)



FILTER-REGULATOR LUBRICATOR WITH PRESSURE GAUGE (0-150PSI - 0-10 BAR)	THREAD in.	MAX. AIR FLOW		MAX. PRESSURE Inlet (psi/bar)	OIL CAPACITY		PART NUMBER	
		cfm	l/s		oz	ml	NPT	BSP
2 STAGE	1/4 G	24	11	150/10	3.4	100	894 016 851 5	894 016 847 8
2 STAGE	1/2 G	110	50	246/17	6.8	201	894 016 851 7	894 016 848 0
2 STAGE	3/4 G	220	100	246/17	6.8	201	894 016 851 9	894 016 848 3
3 STAGE	1/4 G	24	11	150/10	3.4	100	894 016 851 6	894 016 847 9
3 STAGE	1/2 G	110	50	246/17	6.8	201	894 016 851 8	894 016 848 1
3 STAGE	3/4 G	220	100	246/17	6.8	201	894 016 852 0	894 016 848 4

Included with the units: Filter 5µm, Pressure gauge 0-150 psi - 0-10 bar, Microfog lubricator, Automatic drain valve

FILTER UNIT	THREAD in.	PART NUMBER	
		NPT	BSP
1 STAGE	1/4 G	894 016 909 1	894 016 909 0
1 STAGE	1/2 G	894 016 909 9	894 016 909 8
1 STAGE	3/4 G	894 016 910 7	894 016 910 6

REGULATOR UNIT	THREAD in.	PART NUMBER	
		NPT	BSP
1 STAGE	1/4 G	894 016 909 3	894 016 909 2
1 STAGE	1/2 G	894 016 910 1	894 016 910 0
1 STAGE	3/4 G	894 016 910 9	894 016 910 8

PRESSURE GAUGE	SIZE		Ø	MAX PRESSURE	PART NO.
	in.	mm			
1/8" - 0-10	1/8"G	1.57	40	150 PSI (10bar)	894 016 917 8
1/8" - 0-10	1/8"NTP	1.57	40	150 PSI (10bar)	894 016 917 9
1/8" - 0-10	1/8"G	1.97	50	150 PSI (10bar)	894 016 918 0
1/8" - 0-10	1/8"NTP	1.97	50	150 PSI (10bar)	894 016 918 1

FRL PORTABLE STAND	PART NUMBER
COMPATIBLE WITH ALL SIZES OF CP FRL UNITS	894 016 911 4



LUBRICATOR UNIT	THREAD in.	PART NUMBER	
		NPT	BSP
1 STAGE	1/4 G	894 016 909 5	894 016 909 4
1 STAGE	1/2 G	894 016 910 3	894 016 910 2
1 STAGE	3/4 G	894 016 911 1	894 016 911 0

FILTER-REGULATOR	THREAD in.	PART NUMBER	
		NPT	BSP
1 STAGE	1/4 G	894 016 909 7	894 016 909 6
1 STAGE	1/2 G	894 016 910 5	894 016 910 4
1 STAGE	3/4 G	894 016 911 3	894 016 911 2

SPRAY PAINT UNIT	PART NUMBER
Filter 0.01µM	894 016 982 6

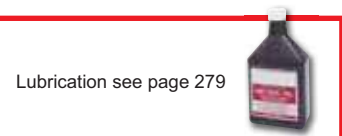

Lubrication see page 279

Hoses

Desoutter offers the highest quality of PVC, Rubber and Polyurethane hoses in the Industrial Line to cover the different needs of applications with Power Tools

In addition to this, the EFFI series is designed with special features such as low weight and flexibility, to meet the highest ergonomic demands, as well as antistatic for applications with ESD demands

HOSES

HOSE RECOMMENDATIONS

DESCRIPTION	EFFI PVC ESD	EFFI PVC	EFFI MAX	PVC	POLYURETHAN	RUBBER
Flexibility	+++	+++	++	++	++	+
Lightweighth	+++	+++	++	++	++	+
Outdoor	++	++	+++	+	+	+++
Spark resistant	-	-	+++	-	-	+++
Rough environment	++	++	+++	+	++	+++
Antistatic	+++	-	+++	-	-	+++
Temperature range	-5 to +140F° -15 to +60°C	-13 to +140F° -25 to +60°C	-40 to +194F° -40 to +90°C	-13 to +140F° -25 to +60°C	-22 to +176F° -30 to +80°C	-40 to +194F° -40 to +90°C



At recommended air flow the pressure drop is 2.9 PSI / 0.2bar with a hose length of 16 ft / 5m.
Recommendation is to upgrade one size in diameter for every 32.8 ft / 10m of hose length

EFFI SERIES

EFFI is a unique premium line of hoses designed with special features such as antistatic, extreme low weight, resistance and durability that will help the operator to maximize the tool productivity.

EFFI PVC ESD HOSES

Aimed to electrostatic sensitive devices manufacturers (electronics, radio, communication fields..)

- Antistatic
- Silicone free
- Extra flexible



DIMENSIONS (IDxOD)		LENGTH		MAX WORKING PRESSURE*	AIR FLOW		WEIGHT PER 98 ft/30m		PART NUMBER
in. ID	mm	ft	m	PSI (bar)	cfm	l/s	lb	kg	
1/4	6x11	98.5	30	145 (10)	8.5	4.0	5.1	2.3	615 810 843 0
5/16	8x12	98.5	30	130 (9)	15.8	7.5	5.7	2.6	615 810 844 0
3/8	10x14	98.5	30	116 (8)	27.6	13	5.9	2.7	615 810 845 0
1/2	13x18	98.5	30	101 (7)	44.5	21	10.8	4.4	615 810 846 0

EFFI PVC HOSES

Aimed to generic assembly applications

- Low weight
- Silicone free
- Ergonomic
- Extremely soft and flexible



DIMENSIONS (IDxOD)		LENGTH		MAX WORKING PRESSURE*	AIR FLOW		WEIGHT PER 98 ft/30m		PART NUMBER
in. ID	mm	ft	m	PSI (bar)	cfm	l/s	lb	kg	
1/4	6x9	98.5	30	261 (18)	8.5	4.0	2.6	1.2	615 810 847 0
5/16	8x10.5	98.5	30	261 (18)	15.9	7.5	3.7	1.7	615 810 848 0
3/8	10x13	98.5	30	203 (14)	27.6	13	4.6	2.1	615 810 849 0
1/2	13x16.5	98.5	30	188 (13)	44.5	21	6.6	3.0	615 810 850 0
5/8	16x21	98.5	30	159 (11)	91.1	43	11.9	5.4	615 810 851 0
3/4	20x24	98.5	30	159 (11)	159	75	12.8	5.8	615 810 852 0
1	25x31	98.5	30	145 (10)	265	125	22.9	10.4	615 810 853 0

EFFI MAX HOSES

Aimed to generic grinding applications

- Exteme low weight
- Antistatic
- Rubber hose
- Soft and flexible
- Welding spatter resistant



DIMENSIONS (IDxOD)		LENGTH		MAX WORKING PRESSURE*	AIR FLOW		WEIGHT PER 65.6 ft/20m		PART NUMBER
in. ID	mm	ft	m	PSI (bar)	cfm	l/s	lb	kg	
1/2	13x18.6	65.6	20	232 (16)	44.5	21	8.6	3.9	615 810 900 0
5/8	16x22.5	65.6	20	232 (16)	91.1	43	10.6	4.8	615 810 901 0
3/4	20x26.1	65.6	20	232 (16)	159	75	11.9	5.4	615 810 902 0

* With a safety factor of 37.4 psi at 68F° (3 bar at 20°C)
(at the max temp of +140F° (+60°C) the working pressure should be reduced by 50%)

PVC, RUBBER AND POLYURETHANE HOSES

Standard quality hose in PVC, PUR and Rubber will provide the best quality product for the price for optimized work with pneumatic tools.

PVC HOSES

Aimed to heavy duty applications (workshops, factories, garages etc.) For indoor use.

- Long service life
- Pliable
- Transparent



DIMENSIONS (IDxOD)		LENGTH		MAX WORKING PRESSURE*	AIR FLOW		WEIGHT PER 98 ft./30m		PART NUMBER
in. ID	mm	ft	m	PSI (bar)	cfm	l/s	lb	kg	
1/8	3x7	98.5	30	290 (20)	1.5	0.7	3.1	1.4	615 810 854 0
3/16	5x9	98.5	30	261 (18)	4.4	2.1	4.2	1.9	615 810 855 0
1/4	6x11	98.5	30	261 (18)	8.5	4.0	5.5	2.5	615 810 856 0
5/16	8x12	98.5	30	261 (18)	15.8	7.5	6.4	2.9	615 810 857 0
3/8	10x14	98.5	30	203 (14)	27.5	13	8.2	3.7	615 810 858 0
1/2	13x18	98.5	30	188 (13)	44.5	21	13.0	5.9	615 810 859 0
5/8	16x22	98.5	30	174 (12)	91.1	43	15.9	7.2	615 810 860 0
3/4	20x25	98.5	30	174 (12)	159	75	18.3	8.3	615 810 861 0
1	25x32	98.5	30	159 (11)	265	125	27.6	12.5	615 810 862 0

RUBBER HOSES

Aimed to the most demanding tasks in construction, mining, shipyards, foundries etc.

- Durable
- Antistatic
- Grinding and welding spatter resistant



DIMENSIONS (IDxOD)		LENGTH		MAX WORKING PRESSURE*	AIR FLOW		WEIGHT PER 65.6ft./20m		PART NUMBER
in. ID	mm	ft	m	PSI (bar)	cfm	l/s	lb	kg	
3/8	10x16	65.6	20	232 (16)	27.5	13	7.9	3.6	615 810 864 0
1/2	12.5x19.1	65.6	20	232 (16)	44.5	21	10.4	4.7	615 810 865 0
5/8	16x23	65.6	20	232 (16)	91.1	43	13.4	6.1	615 810 866 0
3/4	20x26.6	65.6	20	232 (16)	159	75	17.2	7.8	615 810 868 0
1	25x34	65.6	20	232 (16)	265	125	26.0	11.8	615 810 870 0

POLYURETHANE HOSES

Aimed to heavy duty applications for indoor and outdoor use

- Oil resistant
- Flexible
- Long service life
- PVC free:
- Environment friendly



DIMENSIONS (IDxOD)		LENGTH		MAX WORKING PRESSURE*	AIR FLOW		WEIGHT PER 82ft./25m		PART NUMBER
in. ID	mm	ft	m	PSI (bar)	cfm	l/s	lb	kg	
1/4	6.5x10	82	25	290 (20)	8.5	4.0	2.9	1.3	615 804 623 0
5/16	8x12	82	25	290 (20)	15.9	7.5	4.8	2.2	615 804 624 0
3/8	9.5x13	82	25	232 (16)	27.5	13.0	5.5	2.5	615 804 625 0
1/2	13x18	82	25	188 (13)	44.5	21.0	8.8	4.0	615 804 626 0

* With a safety factor of 37.4 psi at 68F° (3 bar at 20°C)
(at the max temp of +140F° (+60°C) the working pressure should be reduced by 50%)

HOSE KITS

Hose kits are equipped with end thread fittings and available in short length, ready to connect and ready to use.

DIMENSIONS (IDxOD)	MALE			LENGTH	PART NUMBER		HOSE MATERIAL
	in.	mm	in.		NPT	BSP	
1/4 6.5x10	1/4	26.2	8	615 811 213 0	615 804 627 0	PU	
5/16 8x12	1/4	26.2	8	615 811 214 0	615 804 628 0	PU	
3/8 10x13	1/4	26.2	8	615 811 215 0	615 804 629 0	PU	
3/8 10x13	3/8	26.2	8	615 811 240 0	615 811 238 0	PU	
1/2 13x18	1/2	26.2	8	615 811 216 0	615 804 630 0	PU	
1/2 13x18	3/8	26.2	8	615 811 241 0	615 811 239 0	PU	
5/8 16x23	1/2	26.2	8	615 811 268 0	615 811 267 0	Rubber	



RUBBER HOSE WHIPS

Always use a hose whip between the tool and the air supply hose. It provides safety and longer tool air inlet life.



HOSE DIAM.	THREAD SIZE	HOSE LENGTH			PART NUMBER	
		in.	ft	m	NPT	BSP
1/4	6.5	1/4	2.0	0.6	CA046270	615 811 191 0
3/8	10	1/4	2.0	0.6	CA047270	615 811 192 0
1/2	13	3/8	2.0	0.6	CA049271	615 811 264 0
1/2	13	1/2	2.0	0.6	CA049270	615 811 193 0
5/8	16	1/2	2.0	0.6	615 811 266 0	615 811 265 0

POLYURETHANE SPIRAL HOSE

Spiral hose are especially adapted for tools used at varying distances. Vertically or horizontally, together with a balancer spiral hose, it is a step forward in ergonomics. Equipped with ball bearing at one end (except the 11x16), they can be directly connected at the tool outlet, avoiding the hose to twist

- Self retractable
- Light and flexible
- Strong and durable

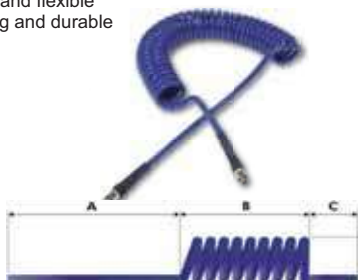

DIMENSIONS (IDxOD)	MALE THREADS	WORKING LENGTH		LENGTH			PART NUMBER	
		ft	m	A in. (mm)	B in. (mm)	C in. (mm)	NPT	BSP
1/4 6.5x10	1/4	6.6	2	19.7 (500)	5.5 (140)	5.9 (150)	615 810 967 0	615 804 635 0
1/4 6.5x10	1/4	13.1	4	19.7 (500)	13 (330)	5.9 (150)	615 810 968 0	615 804 636 0
1/4 6.5x10	1/4	19.7	6	19.7 (500)	20.1 (510)	5.9 (150)	615 810 969 0	615 804 637 0
1/4 6.5x10	1/4	26.2	8	19.7 (500)	27.6 (700)	5.9 (150)	615 810 970 0	615 804 638 0
5/16 8x12	3/8	6.6	2	19.7 (500)	5.1 (130)	5.9 (150)	615 810 971 0	615 804 639 0
5/16 8x12	3/8	13.1	4	19.7 (500)	11.8 (300)	5.9 (150)	615 810 972 0	615 804 640 0
5/16 8x12	3/8	19.7	6	19.7 (500)	18.1 (460)	5.9 (150)	615 810 973 0	615 804 641 0
5/16 8x12	3/8	26.2	8	19.7 (500)	24.8 (630)	5.9 (150)	615 810 974 0	615 804 642 0
7/16 11x16	3/8	6.6	2	19.7 (500)	4.7 (120)	5.9 (150)	615 810 975 0	615 804 643 0
7/16 11x16	3/8	13.1	4	19.7 (500)	10.6 (270)	5.9 (150)	615 810 976 0	615 804 644 0
7/16 11x16	3/8	19.7	6	19.7 (500)	16.5 (420)	5.9 (150)	615 810 977 0	615 804 645 0
7/16 11x16	3/8	26.2	8	19.7 (500)	22.4 (570)	5.9 (150)	615 810 978 0	615 804 646 0

Hose Reels

CUSTOMERS BENEFITS

- No hoses on the ground for improved safety
- From 3.3 to 33 ft / 49 or 52 ft (1 to 10 / 15 or 16 m) hose lengths with feedback force for a clean work space
- Directional swivel-plate to help you correctly reach your application
- High airflow for maximum productivity
- Lightweight and flexible polyurethane hose to reduce operator fatigue
- Open Reels with rubber hose available for heavy-duty grinding/spark areas
- Working temperatures: -30°C+ 60°C (-4°F +140°F)

APPLICATIONS

- Workshops and service stations in the automotive, truck, earthmoving and farming industry
- Industrial assembly lines
- Shipyards, Foundries



A



HR S, HR M & HR L / Hose Reel Small Closed
Composite Series
Compact and ergonomic plastic casing air hose reel
Airflow > 14.8 cfm (7 l/s)

B



HR M / Hose Reel Medium Closed
Steel Series
Heavy-duty air hose reels in steel for longest lifetime
Airflow > 21.2 cfm (10 l/s)

C



HRO M / Hose Reel Medium Open
Steel Series
Heavy-duty air hose reel in industrial quality
Airflow > 17.6 cfm (8.5 l/s)

D



HRO L / Hose Reel Large Open
Steel Series
Heavy-duty air hose reel in industrial quality
Airflow > 33.6 cfm (16 l/s)

E



CP9445H 3/8HD / Hose Reel 50FT 15M
CP9455H 1/2HD / Hose Reel 50FT 15M
Steel Series
Heavy-duty air hose reel in industrial quality

PIC REF	MODEL	CONNECTION	LENGTH		Ø INTERNAL		FLUID	HOSE MATERIAL	INLET	WEIGHT		MAX. PRESSURE		AIR FLOW		PART NUMBER		
			IN (in.)	OUT (in.)	ft	m				in.	mm	lb	kg	PSI	bar		cfm	l/s
A	HR S HOSE REEL	BSP	1/4	1/4	33	10	5/16	8	Air	100% Polyurethane	feet lead-hose 3.3 ft (1m)	9.9	4.5	232	16	14.1	7	615 804 502 0
A	HRN S HOSE REEL	NPT	1/4	1/4	33	10	5/16	8	Air	100% Polyurethane	feet lead-hose 3.3 ft (1m)	9.9	4.5	232	16	14.1	7	615 804 503 0
A	HR M HOSE REEL	BSP	1/4	1/4	33	10	3/8	10	Air	100% PUR (1.2m)	feet lead-hose 4 ft (1.22m)	11	5	290	20	21.2	10	615 810 961 0
A	HRN M HOSE REEL	NPT	1/4	1/4	33	10	3/8	10	Air	100% PUR (1.2m)	feet lead-hose 4 ft (1.22m)	11	5	290	20	21.2	10	615 810 962 0
A	HR L HOSE REEL	BSP	1/4	1/4	49	15	3/8	10	Air	100% Polyurethane	feet lead-hose 3.3 ft (1m)	15.2	6.9	232	16	21.2	10	894 016 982 5
A	HR L HOSE REEL	NPT	1/4	1/4	49	15	3/8	10	Air	100% Polyurethane	feet lead-hose 3.3 ft (1m)	15.2	6.9	232	16	21.2	10	894 016 982 7
B	HR M HOSE REEL	BSP	1/4	1/4	33	10	3/8	10	Air	100% Polyurethane	feet lead-hose 4.9 ft (1.5m)	18.7	8.5	290	20	21.2	10	615 804 504 0
B	HRN M HOSE REEL	NPT	1/4	1/4	33	10	3/8	10	Air	100% Polyurethane	feet lead-hose 4.9 ft (1.5m)	18.7	8.5	290	20	21.2	10	615 804 505 0
C	HRO M HOSE REEL	BSP	1/4	1/4	52	16	3/8	10	Air	100% Polyurethane	feet lead-hose 4.9 ft (1.5m)	24.3	11	290	20	17.6	8.5	615 804 506 0
C	HROR M HOSE REEL	BSP	3/8	3/8	49	15	3/8	10	Air / Water	Rubber (SBR+NR/SBR+EDM)	feet lead-hose 4.9 ft (1.5m)	24.3	11	290	20	17.6	8.5	615 804 510 0
C	HRNO M HOSE REEL	NPT	1/4	1/4	52	16	3/8	10	Air	100% Polyurethane	feet lead-hose 4.9 ft (1.5m)	24.3	11	290	20	17.6	8.5	615 804 507 0
C	HRNOR M HOSE REEL	NPT	3/8	3/8	49	15	3/8	10	Air / Water	Rubber (SBR+NR/SBR+EDM)	feet lead-hose 4.9 ft (1.5m)	24.3	11	290	20	17.6	8.5	615 804 511 0
D	HRO L HOSE REEL	BSP	3/8	3/8	52	16	1/2	13	Air	100% Polyurethane	feet lead-hose 4.9 ft (1.5m)	30.9	14	290	20	33.5	16	615 804 508 0
D	HROR L HOSE REEL	BSP	3/8	3/8	49	15	1/2	13	Water	Rubber (SBR+NR/SBR+EDM)	feet lead-hose 4.9 ft (1.5m)	30.9	14	290	20	33.5	16	615 804 512 0
D	HRNO L HOSE REEL	NPT	3/8	3/8	52	16	1/2	13	Air	100% Polyurethane	feet lead-hose 4.9 ft (1.5m)	30.9	14	290	20	33.5	16	615 804 509 0
D	HRNOR L HOSE REEL	NPT	3/8	3/8	49	15	1/2	13	Water	Rubber (SBR+NR/SBR+EDM)	feet lead-hose 4.9 ft (1.5m)	30.9	14	290	20	33.5	16	615 804 513 0
E	CP9445H 3/8HD	NPT	3/8	3/8	49	15	3/8	10	Air / Water	Rubber	feet lead-hose 4.9 ft (1.5m)	50	22.7	300	21	-	-	894 109 435 2
E	CP9455H 1/2HD	NPT	1/2	1/2	49	15	1/2	13	Air / Water	Rubber	feet lead-hose 4.9 ft (1.5m)	50	25.8	300	21	-	-	894 109 455 1

Couplings

Desoutter offers a wider range of couplings to create the best possible solution together with Power Tools. The range consists of four types of couplings with different characteristics, all with the focus on quality, ergonomics and performance. To cover most of the global needs Desoutter offers three types of nipple profiles, Euro-, ISO 6150B- and the Asian profile. With the Easy Flow coupling Desoutter can present a unique coupling with no air restriction, minimizing the pressure drop.

Thanks to its innovative design EF is suited for rough environment and it is easy and secure to connect and disconnect with the push and bend principle.

The safety feature in EF and Safety Couplings are vented versions to minimize the risk of sudden separation of coupling and nipple.

	Air Flow	Safety feature	Rough environment	Durability	Ergonomics
EF	+++	++	++	++	+++
Safety	++	+++	+	+	+
Quick Release	++	-	+	++	+++
Claw	+++	-	+++	+++	-

Max air flow capacity (Delta 7.2 psi / 0.5 bar) - Economical air flow (Delta 2.9 psi (0.2 bar))

FITTINGS ADAPTABILITY

Nipple		ISO6105B 6mm	EURO 7.6mm	EURO 10.4mm	ASIA 7.5mm
CEJN	310	X			
	320		X		
	410			X	
TEMA	1300	X			
	1600		X		
	1700			X	
ARO	23-23902	X			
RECTUS	14 - 22	X			
	25 (KA, KB, KD, KE, KL, KS)		X		
	26 (KA, KB, KE) 27		X	X	
PREVOST	ARM-ASC-ARC-06 ESC 07	X	X		
LEGRIS	14 - 22	X			
	25 (KA, KB, KD, KE, KL, KS)		X		
NITTO	Hi CUPLA200				X

EF COUPLING - EURO SERIES: EUROPE

EF COUPLING - EURO 7.6mm / Max air flow capacity 79 cfm / 37.5 l/s (Delta 7.2 psi / 0.5 bar)
Economical air flow 53 cfm - 25 l/s (Delta 2.9 psi / 0.2 bar)

NIPPLES EURO 7.6mm



MALE THREAD	PART NUMBER
in.	BSP
1/4	615 810 5140
3/8	615 810 5150
1/2	615 810 5160



FEMALE THREAD	PART NUMBER
in.	BSP
1/4	615 810 5170
3/8	615 8105 180
1/2	615 810 5190



HOSE CONNECTION	PART NUMBER
mm	
6	615 810 5500
8	615 810 5530
10	615 810 5540
13	615 810 5550



MALE THREAD	PART NUMBER	
in.	BSP	NPT
1/4	615 810 588 0	615 810 594 0
3/8	615 810 589 0	615 810 595 0
1/2	615 810 590 0	615 810 596 0



FEMALE THREAD	PART NUMBER
in.	BSP
1/4	615 810 591 0
3/8	615 810 592 0
1/2	615 810 593 0



HOSE CONNECTION	PART NUMBER
mm	
6	615 810 622 0
8	615 810 625 0
10	615 810 626 0
13	615 810 627 0

EF COUPLING - EURO 10.4mm / Max air flow capacity 153 cfm - 72 l/s (Delta 7.2 psi / 0.5 bar)
Economical air flow 102 cfm - 48 l/s (Delta 2.9 psi / 0.2 bar)

NIPPLES EURO 10.4mm



MALE THREAD	PART NUMBER
in.	BSP
3/8	615 810 639 0
1/2	615 810 640 0
3/4	615 810 641 0



FEMALE THREAD	PART NUMBER
in.	BSP
3/8	615 810 642 0
1/2	615 810 643 0
3/4	615 810 644 0



HOSE CONNECTION	PART NUMBER
mm	
10	615 810 651 0
13	615 810 652 0
16	615 810 653 0
19	615 810 654 0



MALE THREAD	PART NUMBER	
in.	BSP	NPT
3/8	615 810 665 0	615 810 668 0
1/2	615 810 666 0	615 810 669 0
3/4	615 810 667 0	615 810 670 0



FEMALE THREAD	PART NUMBER
in.	BSP
3/8	615 810 671 0
1/2	615 810 672 0
3/4	615 810 673 0



HOSE CONNECTION	PART NUMBER
mm	
10	615 810 677 0
13	615 810 678 0
16	615 810 679 0
19	615 810 680 0

Couplings

EF COUPLING - ISO 6150B MIL-C4109: NORTH AMERICA, FRANCE, ITALY



EF COUPLING - ISO 6150B 6mm / Max air flow capacity 36 cfm - 16.7 l/s (Delta 7.2 psi / 0.5 bar)
Economical air flow 23.3 cfm - 11 l/s (Delta 2.9 psi / 0.2 bar)

NIPPLES ISO 6150B 6 mm



MALE THREAD		PART NUMBER	
in.	BSP	NPT	
1/4	615 810 485 0	615 810 479 0	
3/8	615 810 486 0	615 810 480 0	
1/2	615 810 487 0	615 810 481 0	



FEMALE THREAD		PART NUMBER	
in.	BSP	NPT	
1/4	615 810 488 0	615 810 482 0	
3/8	615 810 489 0	615 810 483 0	



HOSE CONNECTION	PART NUMBER
mm	
6	615 810 530 0
8	615 810 531 0
10	615 810 532 0
13	615 810 533 0



MALE THREAD		PART NUMBER	
in.	NPT	BSP	
1/4	615 810 562 0	615 810 556 0	
3/8	615 810 563 0	615 810 557 0	
1/2	615 810 564 0	615 810 558 0	



FEMALE THREAD		PART NUMBER	
in.	NPT	BSP	
1/4	615 810 565 0	615 810 559 0	
3/8	615 810 566 0	615 810 560 0	
1/2	615 810 567 0	615 810 561 0	



HOSE CONNECTION	PART NUMBER
mm	
6	615 810 604 0
8	615 810 605 0
10	615 810 606 0
13	615 810 607 0

EF COUPLING - ISO 6150B 8mm / Max air flow capacity 91 cfm - 43 l/s (Delta 7.2 psi / 0.5 bar)
Economical air flow 57 cfm - 27 l/s (Delta 2.9 psi / 0.2 bar)

NIPPLES ISO 6150B 8mm



MALE THREAD		PART NUMBER	
in.	NPT	BSP	
1/4	615 810 498 0	615 810 492 0	
3/8	615 810 499 0	615 810 493 0	
1/2	615 810 500 0	615 810 494 0	



FEMALE THREAD		PART NUMBER	
in.	NPT	BSP	
1/4	615 810 501 0	615 810 495 0	
3/8	615 810 502 0	615 810 496 0	
1/2	615 810 503 0	615 810 497 0	



HOSE CONNECTION	PART NUMBER
mm	
8	615 810 538 0
10	615 810 539 0
13	615 810 540 0
16	615 810 541 0



MALE THREAD		PART NUMBER	
in.	NPT	BSP	
1/4	615 810 574 0	615 810 568 0	
3/8	615 810 575 0	615 810 569 0	
1/2	615 810 576 0	615 810 570 0	



FEMALE THREAD		PART NUMBER	
in.	NPT	BSP	
1/4	615 810 577 0	615 810 571 0	
3/8	615 810 578 0	615 810 572 0	
1/2	615 810 579 0	615 810 573 0	



HOSE CONNECTION	PART NUMBER
mm	
8	615 810 611 0
10	615 810 612 0
13	615 810 613 0
16	615 811 133 0

EF COUPLING - ISO6150B 11mm / Max air flow capacity 162 cfm - 76.5 l/s (Delta 7.2 psi / 0.5 bar)
Economical air flow 110 cfm - 52 l/s (Delta 2.9 psi / 0.2 bar)

NIPPLES ISO 6150B 11mm



MALE THREAD		PART NUMBER	
in.	NPT	BSP	
3/8	615 810 509 0	615 810 505 0	
1/2	615 810 510 0	615 810 506 0	
3/4	615 810 635 0	615 810 634 0	



FEMALE THREAD		PART NUMBER	
in.	NPT	BSP	
3/8	615 810 511 0	615 810 507 0	
1/2	615 810 512 0	615 810 508 0	
3/4	615 810 637 0	615 810 636 0	



HOSE CONNECTION	PART NUMBER
mm	
10	615 810 546 0
13	615 810 547 0
16	615 810 548 0
19	615 810 549 0



MALE THREAD		PART NUMBER	
in.	NPT	BSP	
3/8	615 810 584 0	615 810 580 0	
1/2	615 810 585 0	615 810 581 0	
3/4	615 810 692 0	615 810 691 0	



FEMALE THREAD		PART NUMBER	
in.	NPT	BSP	
3/8	615 810 586 0	615 810 582 0	
1/2	615 810 587 0	615 810 583 0	
3/4	615 810 694 0	615 810 693 0	



HOSE CONNECTION	PART NUMBER
mm	
10	615 810 618 0
13	615 810 619 0
16	615 810 620 0
19	615 810 621 0

Couplings

EF COUPLING - ASIA 7.5MM: JAPAN, CHINA, INDIA

EF COUPLING - ASIA 7.5mm / Max air flow capacity 72 cfm - 34 l/s (Delta 7.2 psi / 0.5 bar)
Economical air flow 48.7 cfm - 23 l/s (Delta 2.9 psi (0.2 bar))

NIPPLES ASIA 7.5mm



MALE THREAD		PART NUMBER
in.		R
1/4		615 810 656 0
3/8		615 810 657 0
1/2		615 810 658 0



FEMALE THREAD		PART NUMBER
in.		R
1/4		615 810 659 0
3/8		615 810 660 0
1/2		615 810 661 0



HOSE CONNECTION		PART NUMBER
mm		
6		615 810 871 0
8		615 810 662 0
10		615 810 663 0
13		615 810 664 0



MALE THREAD		PART NUMBER
in.		R
1/4		615 810 681 0
3/8		615 810 682 0
1/2		615 810 683 0



FEMALE THREAD		PART NUMBER
in.		R
1/4		615 810 684 0
3/8		615 810 685 0
1/2		615 810 687 0



HOSE CONNECTION		PART NUMBER
mm		
6		615 810 697 0
8		615 810 688 0
10		615 810 689 0
13		615 810 690 0

SAFETY COUPLINGS

EURO 7.6mm / Max air flow capacity 72 cfm - 34 l/s (Delta 7.2 psi / 0.5 bar)
Economical air flow 47 cfm - 22 l/s (Delta 2.9 psi (0.2 bar))



HOSE CONNECTION		PART NUMBER
	BSP	
6		615 811 166 0
8		615 811 167 0
10		615 811 168 0
12,5		615 811 169 0



MALE THREAD		PART NUMBER
in.	BSP	
1/4		615 811 170 0
3/8		615 811 171 0
1/2		615 811 172 0



FEMALE THREAD		PART NUMBER
in.	BSP	
1/4		615 811 174 0
3/8		615 811 175 0
1/2		615 811 176 0

Nipples Euro
7.6mm
see page 273



EURO 10.4mm / Max air flow capacity 134 cfm - 62 l/s (Delta 7.2 psi / 0.5 bar)
Economical air flow 86.2 cfm - 40.7 l/s (Delta 2.9 psi (0.2 bar))



HOSE CONNECTION		PART NUMBER
	BSP	
10		615 811 184 0
13		615 811 185 0
16		615 811 186 0



MALE THREAD		PART NUMBER
in.	BSP	
1/4		615 811 187 0
3/8		615 811 188 0
1/2		615 811 189 0



FEMALE THREAD		PART NUMBER
in.	BSP	
1/2		615 811 190 0

Nipples Euro
10.4mm
see page 273



CLAW COUPLINGS

Economical air flow 593 cfm - 280 l/s



MALE THREAD	PART NUMBER	
	NPT	BSP
3/8	615 810 907 0	615 810 903 0
1/2	615 810 908 0	615 810 904 0
3/4	615 810 909 0	615 810 905 0
1	615 810 910 0	615 810 906 0



FEMALE THREAD	PART NUMBER	
	NPT	BSP
3/8	615 810 915 0	615 810 911 0
1/2	615 810 916 0	615 810 912 0
3/4	615 810 917 0	615 810 913 0
1	615 810 918 0	615 810 914 0



HOSE CONNECTION	PART NUMBER	
	US Universal	DIN Standard 3489
1/4 (6.5mm)	-	615 810 919 0
3/8 (10mm)	615 810 927 0	615 810 920 0
1/2 (13mm)	615 810 928 0	615 810 921 0
5/8 (16mm)	-	615 810 922 0
3/4 (19mm)	615 810 929 0	615 810 923 0
1 (25.4mm)	615 810 930 0	615 810 924 0

Couplings

QUICK RELEASE COUPLINGS - EURO SERIES: EUROPE

EURO 7.6mm / Max air flow capacity 72 cfm - 34 l/s (Delta 7.2 psi / 0.5 bar)
Economical air flow 40 cfm - 19 l/s (Delta 2.9 psi : 0.2 bar)



MALE THREAD	PART NUMBER
in.	BSP
1/4	615 811 072 0
3/8	615 811 073 0
1/2	615 811 074 0



FEMALE THREAD	PART NUMBER
in.	BSP
1/4	615 811 075 0
3/8	615 811 076 0
1/2	615 811 077 0



HOSE CONNECTION	PART NUMBER
mm	
6	615 811 078 0
8	615 811 079 0
10	615 811 080 0
13	615 811 081 0

Nipples Euro
7.6mm
see page 273



EURO 10.4mm / Max air flow capacity 121 cfm - 57 l/s (Delta 7.2 psi / 0.5 bar)
Economical air flow 78 cfm - 37 l/s (Delta 2.9 psi / 0.2 bar)



MALE THREAD	PART NUMBER
in.	BSP
1/4	615 811 082 0
3/8	615 811 083 0
1/2	615 811 084 0



FEMALE THREAD	PART NUMBER
in.	BSP
1/4	615 811 085 0
3/8	615 811 086 0
1/2	615 811 087 0



HOSE CONNECTION	PART NUMBER
mm	
6	615 811 088 0
8	615 811 089 0
10	615 811 090 0
13	615 811 091 0

Nipples Euro
10.4mm
see page 273

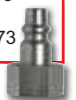

QUICK RELEASE COUPLINGS - ISO 6150B MIL-C4109: NORTH AMERICA, FRANCE, ITALY

ISO 6150B 6mm / Max air flow capacity 32 cfm - 15 l/s (Delta 7.2 psi / 0.5 bar)
Economical air flow 23.3 cfm - 11 l/s (Delta 2.9 psi / 0.2 bar)



MALE THREAD	PART NUMBER
in.	NPT
1/4	615 811 042 0
3/8	615 811 043 0
1/2	615 811 044 0



FEMALE THREAD	PART NUMBER
in.	NPT
1/4	615 811 045 0
3/8	615 811 046 0
1/2	615 811 047 0



HOSE CONNECTION	PART NUMBER
mm	
6	615 811 048 0
8	615 811 049 0
10	615 811 050 0
13	615 811 051 0

Nipples ISO 6150B
6mm
see page 274



ISO 6150B 8mm / Max air flow capacity 63 cfm -30 l/s (Delta 7.2 psi / 0.5 bar)
Economical air flow 42 cfm - 20 l/s (Delta 2.9 psi / 0.2 bar)



MALE THREAD	PART NUMBER
in.	NPT
1/4	615 811 052 0
3/8	615 811 053 0
1/2	615 811 054 0



FEMALE THREAD	PART NUMBER
in.	NPT
1/4	615 811 055 0
3/8	615 811 056 0
1/2	615 811 057 0



HOSE CONNECTION	PART NUMBER
mm	
6	615 811 058 0
8	615 811 059 0
10	615 811 060 0
13	615 811 061 0

Nipples ISO 6150B
8mm
see page 274



ISO 6150B 11mm / Max air flow capacity 127 cfm - 60 l/s (Delta 7.2 psi / 0.5 bar)
Economical air flow 85 cfm - 40 l/s (Delta 2.9 psi / 0.2 bar)



MALE THREAD	PART NUMBER
in.	NPT
1/4	615 811 062 0
3/8	615 811 063 0
1/2	615 811 064 0



FEMALE THREAD	PART NUMBER
in.	NPT
1/4	615 811 065 0
3/8	615 811 066 0
1/2	615 811 067 0



HOSE CONNECTION	PART NUMBER
mm	
10	615 811 068 0
13	615 811 069 0
16	615 811 070 0
19	615 811 071 0

Nipples ISO 6150B
11mm
see page 274



QUICK RELEASE COUPLINGS - ASIA 7.5MM: JAPAN, CHINA, INDIA

ASIA 7.5mm / Max air flow capacity 36 cfm - 17 l/s (Delta 7.2 psi / 0.5 bar)
Economical air flow 23.3 cfm - 11 l/s (Delta 2.9 psi / 0.2 bar)



MALE THREAD	PART NUMBER
in.	R
1/4	615 811 032 0
3/8	615 811 033 0
1/2	615 811 034 0



FEMALE THREAD	PART NUMBER
in.	R
1/4	615 811 035 0
3/8	615 811 036 0
1/2	615 811 037 0



HOSE CONNECTION	PART NUMBER
mm	
6	615 811 038 0
8	615 811 039 0
10	615 811 040 0
13	615 811 041 0

Nipples ASIA
7.5mm
see page 275



Connecting Accessories

BALL VALVES

Suitable for air, water and many other liquids and gases



DESCRIPTION	FEMALE THREAD		PART NUMBER	
	in.	NPT	BSP	
CP BAL 08	1/4	615 810 949 0	615 810 941 0	
CP BAL 10	3/8	615 810 950 0	615 810 942 0	
CP BAL 15	1/2	615 810 951 0	615 810 943 0	
CP BAL 20	3/4	615 810 952 0	615 810 944 0	
CP BAL 25	1	615 810 953 0	615 810 945 0	
CP BAL 32	1-1/4	-	615 810 946 0	
CP BAL 40	1-1/2	-	615 810 947 0	
CP BAL 50	2	-	615 810 948 0	

360° SWIVEL AIR INLET

Aimed to improve the working ergonomics, Air flex connectors can rotate 360° eliminating efforts when working in cramped spaces



	PART NUMBER
Swivel	894 015 841 2

* Air Inlet: 1/4" BSP

AIR FLEX

Aimed to improve the working ergonomics, Air flex connectors can rotate 360° eliminating efforts when working in cramped spaces

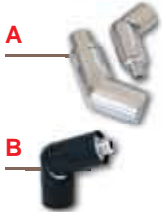

PIC REF	MULTI DIRECTION SWIVEL CONNECTOR	MAX RECOMMENDED FLOW		LENGTH		PART NUMBER		
		cfm	l/s	mm	in.	BSP	NPT	R
A	1/4"	25	12	67	2.63	615 804 746 0	615 804 747 0	615 995 559 0
	3/8"	74	35	82	3.23	615 804 748 0	615 804 749 0	615 995 557 0
	1/2"	74	35	82	3.23	615 804 750 0	615 804 751 0	615 995 558 0
B	1/4"	12	25	67	2.63	615 810 046 0	615 811 375 0	

SIMPLE PRESSURE CLAMPS (TO BE USED WITH PLYERS)



DESCRIPTION		FOR EFFI		FOR PVC		PART NUMBER
in.	mm	ID in.	IDxOD mm	ID in.	IDxOD mm	
0.204-0.244	5.2-6.2	-	-	-	-	615 810 979 0
0.232-0.276	5.9-7.0	-	-	-	-	615 810 980 0
0.276-0.334	7.0-8.5	-	-	1/8	3x7	615 810 981 0
0.334-0.393	8.5-10	1/4	6x9	3/16	5x9	615 810 982 0
0.386-0.464	9.8-11.8	5/16	8x10	1/4	6x11	615 810 983 0
0.445-0.523	11.3-13.3	5/16	8x12	5/16	8x12	615 810 984 0
0.504-0.583	12.8-14.8	3/8	10x13 / 10x14	3/8	9.5x13 / 10x14	615 810 985 0
0.575-0.661	14.6-16.8	1/2	13x16.5	3/8	10x16	615 810 986 0
0.650-0.740	16.5-18.8	1/2	13x18	1/2	13x18	615 810 987 0
0.709-0.799	18.0-20.3	1/2	13x18.6	1/2	12.5x19	615 810 988 0
0.795-0.898	20.2-22.8	5/8	16x21	5/8	16x22	615 810 989 0
0.866-0.976	22.0-24.8	3/8	16x22.5	5/8	16x23	615 810 990 0
0.917-1.035	23.3-26.3	3/4	20x24	-	-	615 810 991 0
1.043-1.181	26.5-30.0	-	-	3/4	20x26.6	615 810 992 0
1.173-1.303	29.8-33.1	1	25x31	1	25x32	615 810 993 0

PRESSURE CLAMP WITH SCREW



DESCRIPTION		FOR EFFI	FOR PVC RUBBER & POLYURETHANE	PART NUMBER
in.	mm	ID in.	ID in.	
0.31-0.55	8-14	1/4-5/16	1/8-1/4-5/16	615 804 673 0
0.43-0.67	11-17	3/8	3/8	615 804 674 0
0.51-0.79	13-20	1/2	1/2	615 804 675 0
0.59-0.94	15-24	-	-	615 804 676 0
0.75-1.10	19-28	5/8	5/8	615 804 677 0
0.87-1.26	22-32	3/4	3/4	615 804 678 0
1.02-1.50	26-38	-	-	615 810 994 0
1.26-1.73	32-44	1	1	615 810 995 0
1.50-1.97	38-50	-	-	615 810 996 0
1.97-2.56	50-65	-	-	615 810 997 0

HEAVY DUTY PRESSURE CLAMP FOR RUBBER



DESCRIPTION		FOR EFFI MAX	FOR RUBBER	PART NUMBER
in.	mm	ID in.	ID in.	
0.87-0.98	22-25	5/8	5/8	615 811 005 0
0.98-1.10	25-28	3/4	3/4	615 811 006 0
1.14-1.26	29-32	-	-	615 811 007 0
1.34-1.50	34-38	-	1	615 811 008 0

Fittings

PIPE CROSS - 4 female threads



THREAD FEMALE		PART NUMBER
in.		BSP
1/4		894 016 941 7
3/8		894 016 941 8
1/2		894 016 941 9

CROSS - 3 female thread / 1 male thread



THREAD FEMALE		MALE	PART NUMBER
in.	in.		BSP
1/4	1/4		894 016 942 0
3/8	3/8		894 016 942 1
1/2	1/2		894 016 942 2

Y CONNECTION female outlet - 1 male inlet



THREAD FEMALE		MALE	PART NUMBER
in.	in.		BSP
1/4	1/4		894 016 942 3
3/8	3/8		894 016 942 4
1/2	1/2		894 016 942 5

Pipe elbow



THREAD FEMALE		MALE	PART NUMBER
in.	in.		BSP
1/4	1/4		894 016 942 6
3/8	3/8		894 016 942 7
1/2	1/2		894 016 942 8
3/4	3/4		894 016 942 9
1	1		894 016 943 0

TEE - 2 female outlet - 1 female inlet



THREAD FEMALE		PART NUMBER
in.		BSP
1/4		894 016 943 1
3/8		894 016 943 2
1/2		894 016 943 3
3/4		894 016 943 4
1		894 016 943 5

TEE - 2 female outlet - 1 male inlet



THREAD FEMALE		MALE	PART NUMBER
in.	in.		BSP
1/4	1/4		894 016 943 6
3/8	3/8		894 016 943 7
1/2	1/2		894 016 943 8
3/4	3/4		894 016 943 9
1	1		894 016 944 0

TEE - 2 female outlet 90° - 1 male inlet



THREAD FEMALE		MALE	PART NUMBER
in.	in.		BSP
1/4	1/4		894 016 944 1
3/8	3/8		894 016 944 2
1/2	1/2		894 016 944 3

HEX HEAD PLUG



THREAD MALE		PART NUMBER
in.		BSP
1/4		894 016 944 4
3/8		894 016 944 5
1/2		894 016 944 6
3/4		894 016 944 7
1		894 016 944 8

CONNECTOR REDUCER



THREAD MALE		FEMALE	PART NUMBER
in.	in.		BSP
1/4	1/8		894 016 944 9
3/8	1/4		895 101 182 3
1/2	1/4		895 101 183 9
1/2	3/8		895 101 182 8
3/4	1/2		894 016 945 0
1	3/4		894 016 945 1

CONNECTOR REDUCER BRASS



THREAD MALE		FEMALE	PART NUMBER
in.	in.		BSP
1/8	1/4		894 016 945 2
1/4	3/8		894 016 945 3
3/8	1/2		894 016 945 4

DOUBLE CONNECTOR



THREAD MALE		MALE	PART NUMBER
in.	in.		BSP
1/8	1/8		894 016 945 5
1/8	1/4		894 016 945 6
1/4	1/4		895 101 182 2
1/4	3/8		895 101 182 4
3/8	3/8		895 101 182 1
3/8	1/2		895 101 182 5
1/2	1/2		895 101 182 7
1/2	3/4		894 016 945 7
3/4	3/4		894 016 945 8
3/4	1		894 016 945 9
1	1		894 016 946 0

ADAPTERS



THREAD MALE		FEMALE	PART NUMBER
BSP	NPT		
1/8	1/8		61103
1/4	1/4		181523
3/8	3/8		894 016 979 7

HOSE STEMS



INNER HOSE DIAMETER		PART NUMBER
in.	mm	BSP
1/4	6	895 101 179 8
3/8	9	895 101 179 9
1/2	13	895 101 180 0

HOSE CONNECTION



THREAD INNER		PART NUMBER
male in.	hose diameter	BSP
1/4	6mm	895 101 180 1
1/4	9mm	895 101 180 2
3/8	9mm	895 101 180 3
3/8	13mm	895 101 180 4
1/2	13mm	895 101 180 5
1/2	16mm	895 101 180 6

MANIFOLD

3/8 inlet on each side - 1/4 outlets 1 side for couplings



CONNECTION THREAD		OUTLET NUMBER	PART NUMBER
inlet in.	outlet in.		BSP
3/8	1/4	4	894 016 941 0
3/8	1/4	5	894 016 941 1
3/8	1/4	6	894 016 941 2

MANIFOLD

3/8 inlet on each side - 1/4 outlets both side couplings



CONNECTION THREAD		OUTLET NUMBER	PART NUMBER
inlet in.	outlet in.		BSP
3/8	1/4	4	894 016 941 3
3/8	1/4	6	894 016 941 4
3/8	1/4	8	894 016 941 5
3/8	1/4	10	894 016 941 6

Other Accessories

LUBRICATION

OIL PROTECTO-LUBE



DESCRIPTION		PART NUMBER
4 oz (0.12 l)	Air Tool Oil	CA149661
20.8 oz (0.591 l)	Air Tool Oil	CA000046
1gal. (3.8 l)	Airoilene Oil	P089507

MINI OILER



DESCRIPTION	PART NUMBER
THREAD 1/4" NPT	205 052 412 3
THREAD 3/8" NPT	205 052 429 3

AIR FLOW REGULATOR



DESCRIPTION	PART NUMBER
Economic flow regulator 1/4"	LC121737
Heavy-duty flow regulator 1/4"	CA085203

BLOW GUN



DESCRIPTION	PART NUMBER
Blow gun standard	615 811 269 0
Blow gun standard silencer	615 811 270 0
Blow gun extended nozzle	615 811 271 0
Blow gun extended nozzle silencer	615 811 272 0

AIR FUSES

When a fitting comes loose from a pressurized hose or the hose is damaged, the hose starts to blow an excessive amount of air in an uncontrolled way, causing hose whip. This can cause injury, and damage to the workpiece and environment.

A way to ensure that this doesn't happen is to use an Air Fuse

It reduces the likelihood of potentially dangerous hose whip caused when a hose bursts or a fitting becomes detached. It quickly shuts off the supply and resets automatically as soon as back pressure in the line downstream is restored.

Air Fuses help to meet OSHA requirement 1926.302 (USA) and may eliminate the need for restraining or shielding hose, as required by European Standard EN983.

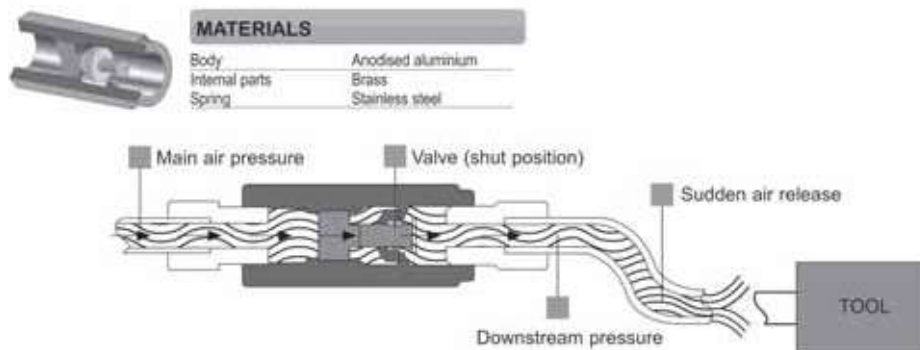

- Reduces risk of hose whip, helping to protect personnel
- Simple and reliable design
- High life expectancy
- Aluminium anodised body for high corrosion resistance
- Auto-Reset to restart downstream activity with the minimum downtime

PORT SIZE	PRESSURE DROP AT SHUT OFF FLOW		SHUT OFF FLOW RATE AT 7 BAR		TOOL MAXIMUM AIR FLOW		FOR FLOW RATES	PART NUMBER	
	bar	psi	l/s	cfm	l/s	cfm		BSP	NPT
1/4"	0.14	2.03	7.8	16.4	5.0	10.5	Low	615 811 242 0	615 811 245 0
1/4"	0.30	4.35	13.0	27.3	10.0	21.0	High	110402	615 811 246 0
3/8"	0.14	2.03	18.0	37.8	10.0	21.0	Low	110422	615 811 247 0
3/8"	0.30	4.35	32.0	67.2	25.0	52.5	High	110432	615 811 248 0
1/2"	0.30	4.35	45.0	94.5	35.0	73.5	High	110442	615 811 249 0
3/4"	0.30	4.35	75.0	157.5	60.0	126.0	High	615 811 243 0	615 811 250 0
1"	0.30	4.35	86.0	180.6	70.0	147.0	High	615 811 244 0	110542

TEST EQUIPMENT

AIR TOOL SIMULATOR / AUDIT CASE



DESCRIPTION	PART NO.
Air tool simulator	615 811 009 0
Audit case	615 811 353 5

Air tool simulator:

To check whether the pressure or air flow is sufficient
The air tool simulator will be connected instead of the pneumatic tool
Supplied with different connections

Audit case:

Intended to conduct tests measuring the dynamic pressure at the tool inlet
Supplied with different connections

Safety Instructions

General Safety Instructions for the Operation of Power Tools

The goal of Desoutter is to produce tools that help the operator work safely and efficiently.

The most important safety device for this or any other tool is the operator. Care and good judgement are the best protection against injury.

All possible hazards cannot be covered here, but we have tried to highlight some of the important ones.

Individuals should look for and obey Caution, Warning and Danger signs placed on tools and displayed in the workplace. Operators should read and follow safety instructions packed with each tool. For a copy of these instructions, contact your local Desoutter representative.

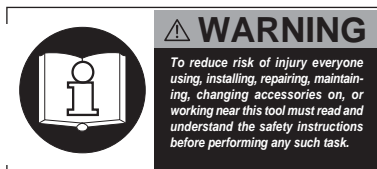

Learn how each tool works. Even if you have previously used similar tools, carefully check out each tool before you use it. Get the 'feel' of it and know its capabilities, limitations, potential hazards, how it operates and how it stops.

All tools are designed to operate at a line pressure of 6.3 bar +/- 0.15bar in accordance with ISO2787.

Sound levels +/- 3dB(A)* are measured in accordance with EN ISO15744. Vibration values* are measured in accordance with ISO 28927.

*These declared values were obtained by laboratory type testing in accordance with the stated standards and are suitable for comparison with the declared values of other tools tested in accordance with the same standards. These declared values are not adequate for use in risk assessments and values measured in individual work places may be higher. The actual exposure values and risk of harm experienced by an individual user are unique and depend upon the way the user works, the workpiece and the workstation design, as well upon the exposure time and the physical condition of the user.

We, Desoutter, cannot be held liable for the consequences of using the declared values, instead of values reflecting the actual exposure, in an individual risk assessment in a work place situation over which we have no control.

Tools are CE marked to comply with European Machinery Directive.

Specifications subject to change without prior notice.

Further occupational health and safety information can be obtained from the following web sites:

<http://www.osha.gov> (USA) <http://europe.osha.eu.int> (Europe).



COMPRESSED AIR HAZARDS

- Air under pressure can cause injury. Never point an air hose at yourself or anyone else. Never blow your clothes free of dust with compressed air. Always direct exhaust air away from yourself and others in the work area.
- Always check for damaged or loose hoses and fittings before using an air tool, and replace if necessary. Whipping hoses can cause serious injury.
- Disconnect the tool from the air supply when not in use, before changing accessories, setting the torque, or when making repairs.
- Do not exceed rated air pressure to increase the output of the tool. This could cause injury and shorten tool life.
- Do not assemble quick coupler on the tool. Vibration can cause breakage resulting in a whipping air hose. Instead, use quick couplers on the end of a short leader hose.
- When universal twist couplings are used, lock pins must be installed to prevent accidental hose disconnection.
- Air tools are not intended for use in explosive atmospheres and are not insulated for contact with electric power sources.



ELECTRICAL HAZARDS

- Power tool plugs must match the outlet. Never modify the plug in any way. Do not use any adaptor plugs with earthed (grounded) power tools and equipment. Unmodified plugs and matching outlets will reduce risk of electric shock.
- Avoid body contact with earthed or grounded metal surfaces. There is an increased risk of electric shock if your body is earthed or grounded.
- Do not abuse the cord. Never use the cord for carrying, pulling or unplugging the power tool. Keep cord away from heat, oil, sharp edges or moving parts. Damaged or entangled cords increase the risk of electric shock.
- Do not expose electric power tools and equipment to wet conditions.
- Do not operate power tools in explosive atmospheres. Power tools create sparks which may ignite dust, fumes or flammable liquids.
- Have electric power tools and equipment serviced by a qualified repair person using only identical replacement parts.



PROJECTILE HAZARDS

- Always wear impact resistant eye and face protection when involved with or near the operation or repair of tools.



BREATHING HAZARDS

- Proper breathing protection must be worn when working with materials, which produce airborne particles.



NOISE HAZARDS

- Hearing loss can result from prolonged exposure to excessive sound levels.
- Use hearing protection as recommended by your employer or Occupational Health and Safety Regulations.



VIBRATION HAZARDS

- Repetitive work motions, awkward positions, and exposure to vibration may be harmful to your hands and arms.
- If numbness, tingling, pain or whitening of the skin occurs, stop using tool and consult a physician.



ENTANGLEMENT HAZARDS

- To reduce the risk of injury from entanglement, do not wear loose clothing when using rotating accessories.



ADDITIONAL HAZARDS

- Slip/Trip/Fall is a major cause of serious injury or death. Beware of excessive hose/cord left on the walking or work surface.
- Operators and maintenance personnel must be physically fit to perform job tasks, and handle the bulk, weight and power of the tool.
- Deburring tools should be used to reduce the risk of cuts and abrasions due to burrs.
- Wear gloves to protect hands from sharp edges.

Safety Instructions

Specific Safety Instructions for Power Tool Groups

In addition to the General Safety Instructions, the following are safety instructions and warnings that apply to the safe operation of specific power tool groups.



COMPRESSION TOOLS

- To reduce the risk of injury always keep hands and fingers away from yoke and moving jaws, sets or dies. If possible, hold the tool body with both hands.
- Inspect the yoke daily for cracks. Injury may result if a cracked yoke fails during use.
- All yokes have a life limitation based on cycles and riveting force. This tool and its accessories must not be modified.



DRILLS & TAPPERS

- Keep away from rotating bit and chuck. You can become cut or burned if you come into contact with the drill bit or tap, chips/swarf, or work surface.
- Use intermittent drill feed pressure to avoid long shaved chips/swarf.
- The drill bit or tap can suddenly bind and cause the workpiece or tool to rotate, causing arm and shoulder injuries.
- It is recommended that side handles are used for operator comfort and safety on high torque drilling applications above 4Nm (3 lbft) on straight case tools and 10Nm (7.4 lbft) on pistol grip drills. Drills with a chuck capacity larger than 10mm (3/8») should always be used with a side handle.



PERCUSSIVE TOOLS

(Riveting Hammers, Air Scribe)

- All chisels, rivet sets and other associated accessories should be checked for cracks, excessive wear, or other physical damage before each use. Accessories that show signs of damage should be replaced immediately.
- Never use a tool without the proper accessory retainer.



IMPULSE WRENCHES

- Never use hand sockets or accessories. Use only impact sockets and accessories in good condition. Sockets in poor condition reduce impact power and could also shatter, resulting in personal injury.
- When using a universal joint, never operate the tool off the work. It may run too fast and cause the joint to be thrown from the tool.
- Always use the simplest hook up possible. Long springy extension bars and adaptors absorb impact power and could break loose resulting in personal injury. Instead, use deep sockets wherever possible.
- For tools using the pin and o-ring socket retainer, use the o-ring to securely retain the socket pin or use a one-piece retainer ring to retain the socket.
- Serious injury can result from overtorqued or under-torqued fasteners, which can break, or loosen and separate. Released assemblies can become projectiles. Assemblies requiring a specific torque must be checked using a torque meter.

NOTE: So-called 'click' torque wrenches do not check for potentially dangerous over-torqued conditions.



ANGLE WRENCHES

- Never use hand sockets or accessories. Use only power drive sockets and accessories.
- To reduce the risk of injury, always support the handle securely in the direction opposite of the spindle rotation to minimize torque reaction.



ACCESSORIES

- Always use accessories of correct size and design for the tool. Tool and accessories must not be modified in any way.
- Never use a tool without the proper accessory retainer.
- Do not use a tool or attachment for a purpose not intended by the manufacturer.



OTHER TOOLS

(e.g. Screwdrivers, Shears, Saws, etc.)

- Specific instructions/warnings affecting this group of tools are contained in product-specific documents accompanying each product.



ABRASIVE TOOLS

- Before grinding, test grinding wheel by briefly running tool at full throttle. Be sure to use a barrier (such as under a heavy work table) to protect yourself from possible broken wheel parts.
- Never mount a grinding wheel on a sander.
- Never use a grinding wheel rated at a speed lower than the air grinder speed.
- All grinding wheels and polishing/sanding accessories should be checked for cracks or other damage before mounting and use.
- Always use the recommended wheel guard to prevent injury when performing grinding operations. If a guard has withstood wheel or disk breakage, it must be replaced.
- Position a guard between the grinding wheel or disc and the operator.
- Use barriers to protect others from fragments and grinding sparks.
- Make sure grinding wheels are mounted according to manufacturer's specifications: always use correct mounting flanges.
- Never tamper with or remove a speed governor from a tool to make it run faster. Periodically check tool speed with a tachometer.

For complete safety instructions, please see the documentation provided with each tool.

Index (Model search)

Vibration level (m/s²) - Noise level (dB(A))

All values are current as of the date of this publication. For the latest information please visit www.desouttertools.com

MODEL	PART NO.	PAGE	VIBRATION LEVEL (3 axes value) ISO 28927		NOISE LEVEL ISO 15744 dB(A)	SOUND LEVEL ISO 15744 dB(A)	MODEL	PART NO.	PAGE	VIBRATION LEVEL (3 axes value) ISO 28927		NOISE LEVEL ISO 15744 dB(A)	SOUND LEVEL ISO 15744 dB(A)
			a m/s ²	K m/s ²						a m/s ²	K m/s ²		
4734	4734	203	3	2.2	77	CVIC II-L2	615 932 676 0	55					
05-X-80000	258984	197	<2.5		76	CVIC II-L4	615 932 678 0	55					
2A89-A-1300	1225434	88	<2.5		64	CVIL II	615 932 680 0	44					
2A89-A-1300	1223154	88	<2.5		64	CVIL II M	615 932 682 0	48					
2A89-A-400	1225694	88	<2.5		64	CVIL II S	615 932 683 0	48					
2A89-A-400	1223314	88	<2.5		64	CVIR II	615 932 681 0	42					
2A89-A-700	1225514	88	<2.5		64	D144-T-3300	1273234	259	<2.5		76		
2A89-A-700	1223234	88	<2.5		64	D16-P-450	1287934	183	<2.5		78		
2D472-LX-550	1388534	101	<2.5		73	D16-P-750	1288084	183	<2.5		78		
2H16-L-160/500-B18	1434264	183	<2.5		76	D170-L	1261574	259	11.7	3.8	76		
2H16-L-250/800-B18	1434184	183	<2.5		76	D3141-L-2100	1383164	177	<2.5		77		
2H16-L-90/250-B18	1434344	183	<2.5		76	D3141-L-770	1383324	177	<2.5		77		
A27-A-1300	1406594	183	<2.5		64	D3141-S-2100	1383084	177	<2.5		77		
Advanced Drilling unit		190				D3141-S-770	1383244	177	<2.5		77		
ALPHA D1	615 9356 104 0	117				D3143-L-2100	1383584	177	<2.5		77		
ALPHA D5	615 9356 105 0	117				D3143-S-2100	1383404	177	<2.5		77		
ALPHA D16	615 9356 106 0	117				D3143-S-770	1383664	177	<2.5		77		
Air Line Network		260				D53-100	615 810 705 0	136					
Air Motors		256				D53-100S	615 810 710 0	136					
Alpha digital torque tester		117				D53-100 X/Y AXLE	615 397 878 0	138					
Auto Feed Drills - AFD		254				D53-100S X/Y AXLE	615 397 883 0	138					
ASD - Schraubenvereinzeler		149				D53-12	615 810 701 0	136					
AV101	128534	259				D53-12 X/Y AXLE	615 397 875 0	138					
Balancers		146				D53-12S	615 810 707 0	136					
Bench mounted swinging arm		144				D53-12S X/Y AXLE	615 397 880 0	138					
Bench tidy kit		144				D53-25	615 810 702 0	136					
C27-AX-1450	1405414	183	<2.5		73	D53-25 X/Y AXLE	615 397 876 0	138					
CP0214ANBEL	T012343	165	<2.5		90	D53-25S	615 810 708 0	136					
CP0214ANFEL	T018671	165	<2.5		90	D53-25S X/Y AXLE	615 397 881 0	138					
CP0214ANGEL	T018672	165	<2.5		90	D53-25X	615 810 703 0	136					
CP0214CELEL	T012344	165	<2.5		90	D53-5	615 810 700 0	136					
CP0214ENBEL	T018678	165	<2.5		96	D53-5 X/Y AXLE	615 397 874 0	138					
CP0214ENFEL	T018163	165	<2.5		96	D53-50	615 810 704 0	136					
CP0214ENGEL	T018164	165	<2.5		90	D53-50 X/Y AXLE	615 397 877 0	138					
CP0214FALEL	T013152	165	<2.5		90	D53-50S	615 810 709 0	136					
CP0214KETEL	T023475	165	<2.5		90	D53-50S X/Y AXLE	615 397 882 0	138					
CP0214SETEL	T023474	165	<2.5		90	D53-5S	615 810 706 0	136					
CP0341CUDEL	T022512	165	<2.5		90	D53-5S X/Y AXLE	615 397 879 0	138					
CP0351ASGEL	T007783	165	<2.5		96	D57	408903	142					
CP0351ASKEL	T007773	165	<2.5		96	D57X	408913	142					
CP0351ASVEL	T009582	165	<2.5		96	D58	408923	142					
CP0351CUDEL	T008955	165	<2.5		90	D59	408933	142					
CP0351ESGEL	T012602	165	<2.5		96	DA6.35	615 176 019 0	225	<2.5		74		
CP0351ESKEL	T012603	165	<2.5		96	DA8.20	615 176 030 0	225	<2.5		77		
CP0351ESREL	T012604	165	<2.5		96	Delta 1D	615 935 101 0	113					
CP0351ESVEL	T012605	165	<2.5		96	Delta 6D	615 935 102 0	113					
CP0351FUDEL	T012608	165	<2.5		90	Delta 7D	615 935 103 0	113					
CP0351-CABH-DY	T020475	168	<2.5		96	Delta Cart		122					
CP0351PU	205 146 721 4	168	<2.5		96	Digital Rotary transducers - DRT		118					
CP4444-1	205 147 938 4	161	4	1.6	98	Digital Static Transducers - DST		120					
CP-4444-RURAB	T022961	161	18.9	9.1	94	DR300-T1000	205 147 480 4	173	<2.5		75		
CP-4444-RUSAB	T022962	161	13.9	5.7	94	DR300-T1000-C10	205 147 481 4	173	<2.5		75		
CP-4444-RUTAB	T022963	161	28.8	10.2	96	DR300-T1000-QR	205 147 523 4	181	<2.5		75		
CP-4447-RUSAB	T022965	161	14.3	4.7	96	DR300-T1000-S5-30	205 147 532 4	178	<2.5		75		
CP-4447-RUTAB	T022912	161	12.6	4.5	92	DR300-T1000-S5-360	205 147 556 4	179	<2.5		75		
CP-4447-RUVAB	T022964	161	10.0	4.8	92	DR300-T1000-S5-45	205 147 569 4	178	<2.5		75		
CP-4450-2	T025189	161	10.2	5.4	94	DR300-T1000-S5-90	205 147 544 4	175	<2.5		75		
CP-4450-3	T025190	161	10.1	4.2	94	DR300-T1000-S6-360	205 147 605 4	179	<2.5		75		
CP-4450-4	T025191	161	12.0	6.5	95	DR300-T1000-S6-90	205 147 587 4	176	<2.5		75		
CP-4475-3	T025241	161	14.5	6.5	95	DR300-T1000-T5-30	205 147 531 4	178	<2.5		75		
CP-4475-4	T025242	161	11.1	4.7	95	DR300-T1000-T5-360	205 147 555 4	179	<2.5		75		
CP-4475-6	T025243	161	7.4	3.2	94	DR300-T1000-T5-45	205 147 568 4	178	<2.5		75		
Customized solutions		124				DR300-T1000-T5-90	205 147 543 4	175	<2.5		75		
CVI3 Function	615 932 690 0	25				DR300-T1000-T6-360	205 147 604 4	179	<2.5		75		
CVI3 Vision	615 932 691 0	25				DR300-T1000-T6-90	205 147 586 4	176	<2.5		75		
CVIC II-H2	615 932 677 0	55				DR300-T2000	205 147 483 4	173	<2.5		75		
CVIC II-H4	615 932 679 0	55				DR300-T20000	205 147 495 4	173	<2.5		75		

Index (Model search)

Vibration level (m/s²) - Noise level (dB(A))

All values are current as of the date of this publication. For the latest information please visit www.desouttertools.com

MODEL	PART NO.	PAGE	VIBRATION LEVEL (3 axes value) ISO 28927		NOISE LEVEL ISO 15744	SOUND LEVEL	MODEL	PART NO.	PAGE	VIBRATION LEVEL (3 axes value) ISO 28927		NOISE LEVEL ISO 15744	SOUND LEVEL
			a m/s ²	K m/s ²						a m/s ²	K m/s ²		
DR300-T20000-C8	205 147 496 4	173	<2.5		75		DR300-T550-T6-360	205 147 601 4	179	<2.5		75	
DR300-T2000-C8	205 147 484 4	173	<2.5		75		DR300-T550-T6-90	205 147 583 4	176	<2.5		75	
DR300-T2000-QR	205 147 524 4	181	<2.5		75		DR350-P1000	205 147 355 4	170	<2.5		77	
DR300-T2000-S5-30	205 147 534 4	178	<2.5		75		DR350-P1000-C10	205 147 244 4	170	<2.5		77	
DR300-T2000-S5-360	205 147 558 4	179	<2.5		75		DR350-P1000-QR	205 147 981 4	181	<2.5		75	
DR300-T2000-S5-45	205 147 572 4	178	<2.5		75		DR350-P2000	205 147 356 4	170	<2.5		77	
DR300-T2000-S5-90	205 147 546 4	175	<2.5		75		DR350-P20000	205 147 359 4	170	<2.5		77	
DR300-T2000-S6-360	205 147 608 4	179	<2.5		75		DR350-P20000-C8	205 147 252 4	170	<2.5		77	
DR300-T2000-S6-90	205 147 590 4	176	<2.5		75		DR350-P2000-C8	205 147 246 4	170	<2.5		77	
DR300-T2000-T5-30	205 147 533 4	178	<2.5		75		DR350-P3000	205 147 357 4	170	<2.5		77	
DR300-T2000-T5-360	205 147 557 4	179	<2.5		75		DR350-P3000-C8	205 147 248 4	170	<2.5		77	
DR300-T2000-T5-45	205 147 571 4	178	<2.5		75		DR350-P3000-QR	205 147 528 4	181	<2.5		75	
DR300-T2000-T5-90	205 147 545 4	175	<2.5		75		DR350-P4500	205 147 384 4	170	<2.5		77	
DR300-T2000-T6-360	205 147 607 4	179	<2.5		75		DR350-P4500-C8	205 147 382 4	170	<2.5		77	
DR300-T2000-T6-90	205 147 589 4	176	<2.5		75		DR350-P5500	205 147 358 4	170	<2.5		77	
DR300-T3000	205 147 486 4	173	<2.5		75		DR350-P5500-C8	205 147 250 4	170	<2.5		77	
DR300-T3000-C8	205 147 487 4	173	<2.5		75		DR350-P5500-QR	205 147 984 4	181	<2.5		75	
DR300-T3000-QR	205 147 525 4	181	<2.5		75		DR350-P5500-C10	205 147 242 4	170	<2.5		77	
DR300-T3000-S5-30	205 147 536 4	178	<2.5		75		DR500-P1000	205 147 660 4	171	<2.5		75	
DR300-T3000-S5-360	205 147 560 4	179	<2.5		75		DR500-P1000-C10	205 147 658 4	171	<2.5		75	
DR300-T3000-S5-45	205 147 575 4	178	<2.5		75		DR500-P1400	205 147 663 4	171	<2.5		75	
DR300-T3000-S5-90	205 147 548 4	175	<2.5		75		DR500-P1400-C10	205 147 661 4	171	<2.5		75	
DR300-T3000-S6-360	205 147 611 4	179	<2.5		75		DR500-P1800	205 147 666 4	171	<2.5		75	
DR300-T3000-S6-90	205 147 593 4	176	<2.5		75		DR500-P1800-C10	205 147 664 4	171	<2.5		75	
DR300-T3000-T5-30	205 147 535 4	178	<2.5		75		DR500-P18500	205 147 678 4	171	<2.5		75	
DR300-T3000-T5-360	205 147 559 4	179	<2.5		75		DR500-P18500-C8	205 147 676 4	171	<2.5		75	
DR300-T3000-T5-45	205 147 574 4	178	<2.5		75		DR500-P2700	205 147 669 4	171	2.6	1.6	75	
DR300-T3000-T5-90	205 147 547 4	175	<2.5		75		DR500-P2700-C8	205 147 667 4	171	2.6	1.6	75	
DR300-T3000-T6-360	205 147 610 4	179	<2.5		75		DR500-P400	205 147 654 4	171	<2.5		75	
DR300-T3000-T6-90	205 147 592 4	176	<2.5		75		DR500-P400-C13	205 147 652 4	171	<2.5		75	
DR300-T4500	205 147 489 4	173	<2.5		75		DR500-P4300	205 147 672 4	171	<2.5		75	
DR300-T4500-C8	205 147 490 4	173	<2.5		75		DR500-P4300-C8	205 147 670 4	171	<2.5		75	
DR300-T4500-QR	205 147 526 4	181	<2.5		75		DR500-P5800	205 147 675 4	171	<2.5		75	
DR300-T4500-S5-30	205 147 538 4	178	<2.5		75		DR500-P5800-C8	205 147 673 4	171	<2.5		75	
DR300-T4500-S5-360	205 147 562 4	179	<2.5		75		DR500-P600	205 147 657 4	171	<2.5		75	
DR300-T4500-S5-45	205 147 578 4	178	<2.5		75		DR500-P600-C13	205 147 655 4	171	<2.5		75	
DR300-T4500-S5-90	205 147 550 4	175	<2.5		75		DR750-P1300	205 147 415 4	172	<2.5		81	
DR300-T4500-S6-360	205 147 614 4	179	<2.5		75		DR750-P1300-C10	1465084	172	<2.5		81	
DR300-T4500-S6-90	205 147 596 4	176	<2.5		75		DR750-P1300-JT1	205 146 662 4	172	<2.5		81	
DR300-T4500-T5-30	205 147 537 4	178	<2.5		75		DR750-P20000	205 147 458 4	172	<2.5		81	
DR300-T4500-T5-360	205 147 561 4	179	<2.5		75		DR750-P20000-C8	205 146 659 4	172	<2.5		81	
DR300-T4500-T5-45	205 147 577 4	178	<2.5		75		DR750-P20000-JT1	205 146 667 4	172	<2.5		81	
DR300-T4500-T5-90	205 147 549 4	175	2.6	1.4	75		DR750-P2700	205 147 416 4	172	<2.5		81	
DR300-T4500-T6-360	205 147 613 4	179	<2.5		75		DR750-P2700-C10	1465094	172	<2.5		81	
DR300-T4500-T6-90	205 147 595 4	176	<2.5		75		DR750-P2700-JT1	205 146 663 4	172	<2.5		81	
DR300-T550	205 147 477 4	173	<2.5		75		DR750-P3300	205 147 455 4	172	<2.5		81	
DR300-T5500	205 147 492 4	173	<2.5		75		DR750-P3300-C10	1465104	172	<2.5		81	
DR300-T5500-C8	205 147 493 4	173	<2.5		75		DR750-P3300-JT1	205 146 664 4	172	<2.5		81	
DR300-T5500-QR	205 147 527 4	181	<2.5		75		DR750-P400	205 147 451 4	172	<2.5		81	
DR300-T5500-S5-30	205 147 540 4	178	<2.5		75		DR750-P400-C13	205 146 658 4	172	<2.5		81	
DR300-T5500-S5-360	205 147 564 4	179	<2.5		75		DR750-P400-JT1	205 146 660 4	172	<2.5		81	
DR300-T5500-S5-45	205 147 581 4	178	<2.5		75		DR750-P4100	205 147 456 4	172	<2.5		81	
DR300-T5500-S5-90	205 147 552 4	175	2.6	1.4	75		DR750-P4100-C8	1465114	172	<2.5		81	
DR300-T5500-S6-360	205 147 617 4	179	<2.5		75		DR750-P4100-JT1	205 146 665 4	172	<2.5		81	
DR300-T5500-S6-90	205 147 599 4	176	<2.5		75		DR750-P6000	205 147 417 4	172	<2.5		81	
DR300-T5500-T5-30	205 147 539 4	178	<2.5		75		DR750-P6000-C8	1465124	172	<2.5		81	
DR300-T5500-T5-360	205 147 563 4	179	<2.5		75		DR750-P6000-JT1	205 146 666 4	172	<2.5		81	
DR300-T5500-T5-45	205 147 580 4	178	<2.5		75		DR750-P750	205 147 452 4	172	<2.5		81	
DR300-T5500-T5-90	205 147 551 4	175	2.6	1.4	75		DR750-P750-C13	1465074	172	<2.5		81	
DR300-T5500-T6-360	205 147 616 4	179	<2.5		75		DR750-P750-JT1	205 146 661 4	172	<2.5		81	
DR300-T5500-T6-90	205 147 598 4	176	<2.5		75		Dust Extraction systems		232				
DR300-T550-C10	205 147 478 4	173	<2.5		75		DWT Vision 150	615 165 756 0	115				
DR300-T550-QR	205 147 522 4	181	<2.5		75		DWT Vision 30	615 165 755 0	115				
DR300-T550-S5-45	205 147 566 4	178	<2.5		75		DWT Vision 800	615 165 758 0	115				
DR300-T550-S6-360	205 147 602 4	179	<2.5		75		DWTA 150	615 165 761 0	116				
DR300-T550-S6-90	205 147 584 4	176	<2.5		75		DWTA 30	615 165 760 0	116				
DR300-T550-T5-45	205 147 565 4	178	<2.5		75								

Index (Model search)

Vibration level (m/s²) - Noise level (dB(A))

All values are current as of the date of this publication. For the latest information please visit www.desouttertools.com

MODEL	PART NO.	PAGE	VIBRATION LEVEL (3 axes value) ISO 28927		NOISE LEVEL ISO 15744 dB(A)	SOUND LEVEL ISO 15744 dB(A)	MODEL	PART NO.	PAGE	VIBRATION LEVEL (3 axes value) ISO 28927		NOISE LEVEL ISO 15744 dB(A)	SOUND LEVEL ISO 15744 dB(A)
			a m/s ²	K m/s ²						a m/s ²	K m/s ²		
DWTA 800	615 165 763 0	116											
DWTA Vision 150	615 165 766 0	115											
DWTA Vision 30	615 165 765 0	115											
DWTA Vision 800	615 165 768 0	115											
EAB 15-900	615 165 731 0	17	<2.5		<70		ECP30S	615 165 204 0	59	<2.5		<70	
EAB 26-560	615 165 732 0	17	<2.5		<70		ECP3L	615 165 199 0	59	<2.5		<70	
EAB 32-410	615 165 733 0	17	<2.5		<70		ECP3LT	615 165 231 0	59	<2.5		<70	
EAB 45-330	615 165 734 0	17	<2.5		<70		ECP4000	615 165 527 0	60	<2.5		<70	
EAB 50-450	615 165 735 0	17	<2.5		<70		ECP40S	615 165 262 0	59	<2.5		<70	
EAB 60-370	615 165 736 0	17	<2.5		<70		ECP550	615 165 400 0	60	<2.5		<70	
EAB 75-300	615 165 737 0	17	<2.5		<70		ECP550-R	615 165 452 0	60	<2.5		<70	
EAB 95-240	615 165 738 0	17	<2.5		<70		ECP5L	615 165 200 0	59	<2.5		<70	
EABC 15-900	615 165 841 0	33	<2.5		<70		ECP5LT	615 165 232 0	59	<2.5		<70	
EABC 26-560	615 165 842 0	33	<2.5		<70		ECP950	615 165 401 0	60	<2.5		<70	
EABC 32-410	615 165 843 0	33	<2.5		<70		ECP950-R	615 165 453 0	60	<2.5		<70	
EABC 45-330	615 165 844 0	33	<2.5		<70		ECS06	615 165 442 0	58	<2.5		<70	
EABC 50-450	615 165 845 0	33	<2.5		<70		ECS06-M20	615 165 454 0	58	<2.5		<70	
EABC 60-370	615 165 846 0	33	<2.5		<70		ECS10	615 165 444 0	58	<2.5		<70	
EABC 75-300	615 165 847 0	33	<2.5		<70		ECS10-M20	615 165 458 0	58	<2.5		<70	
EABC 95-240	615 165 848 0	33	<2.5		<70		ECS16	615 165 459 0	58	<2.5		<70	
EAD105-500	615 165 613 0	29	<2.5		<70		ECS16-M20	615 165 460 0	58	<2.5		<70	
EAD12-1300-CE10-L47-H10-W22	615 165 828 0	31					ECS2	615 165 443 0	58	<2.5		<70	
EAD15-900-OE12-L44-H12-W32	615 165 830 0	31					ECS2-M20	615 165 455 0	58	<2.5		<70	
EAD160-430	615 165 681 0	29	<2.5		<70		ECS4	615 165 445 0	58	<2.5		<70	
EAD18-900-CE10-L47-H15-W22	615 165 829 0	31					ECS4-M20	615 165 456 0	58	<2.5		<70	
EAD18-900-OE13-L51-H11-W38	615 165 831 0	31					ECS7	615 165 446 0	58	<2.5		<70	
EAD200-370	615 165 682 0	29	<2.5		<70		ECS7-M20	615 165 457 0	58	<2.5		<70	
EAD20-1300	615 165 606 0	29	<2.5		<70		ECSA10	615 165 449 0	58	<2.5		<70	
EAD280-260	615 165 683 0	29	<2.5		<70		ECSA2	615 165 447 0	58	<2.5		<70	
EAD280-370	615 165 684 0	29	<2.5		<70		ECSA7	615 165 448 0	58	<2.5		<70	
EAD28-900-CE13-L62-H15-W30	615 165 832 0	31					ECSF06	615 165 501 0	64	<2.5		<70	
EAD32-900	615 165 607 0	29	<2.5		<70		ECSF10	615 165 505 0	64	<2.5		<70	
EAD440-250	615 165 685 0	29	<2.5		<70		ECSF16	615 165 506 0	64	<2.5		<70	
EAD44-800-CE14-L71-H18-W31	615 165 833 0	31					ECSF2	615 165 502 0	64	<2.5		<70	
EAD50-900	615 165 609 0	29	<2.5		<70		ECSF4	615 165 503 0	64	<2.5		<70	
EAD65-500-CE17-L78-H24-W30	615 165 834 0	31					ECSF7	615 165 504 0	64	<2.5		<70	
EAD660-160	615 165 686 0	29	<2.5		<70		EFDA107-510	615 165 862 0	35	<2.5		<70	
EAD70-800	615 165 611 0	29	<2.5		<70		EFDA40-55	615 165 858 0	35	<2.5		<70	
EAD80-650	615 165 612 0	29	<2.5		<70		EFDA51-130	615 165 859 0	35	<2.5		<70	
ECA115	615 165 106 0	62	<2.5		<70		EFDA63-215	615 165 860 0	35	<2.5		<70	
ECA125	615 165 188 0	62	<2.5		<70		EFDA76-340	615 165 861 0	35	<2.5		<70	
ECA15	615 165 192 0	62	<2.5		<70		EFDE43-8	615 165 864 0	34	<2.5		<70	
ECA150	615 165 189 0	62	<2.5		<70		EFDE43-15	615 165 865 0	34	<2.5		<70	
ECA20	615 165 100 0	62	<2.5		<70		EFDE43-30	615 165 866 0	34	<2.5		<70	
ECA200	615 165 190 0	62	<2.5		<70		EFDE43-45	615 165 867 0	34	<2.5		<70	
ECA30	615 165 101 0	62	<2.5		<70		EFDE51-135	615 165 869 0	34	<2.5		<70	
ECA40	615 165 102 0	62	<2.5		<70		EFDE51-70	615 165 868 0	34	<2.5		<70	
ECA60	615 165 103 0	62	<2.5		<70		EFDE60-175	615 165 871 0	34	<2.5		<70	
ECA70	615 165 104 0	62	<2.5		<70		EFDE60-260	615 165 872 0	34	<2.5		<70	
ECA90	615 165 105 0	62	<2.5		<70		EFDE60-95	615 165 870 0	34	<2.5		<70	
ECD120	615 165 097 0	63	<2.5		<70		EID120-660	615 165 677 0	30	<2.5		<70	
ECD20	615 165 093 0	63	<2.5		<70		EID170-670	615 165 678 0	30	<2.5		<70	
ECD30	615 165 094 0	63	<2.5		<70		EID20-900-OE12-L31-H14-W38	615 165 835 0	31				
ECD5	615 165 068 0	63	<2.5		<70		EID25-1200	615 165 614 0	30	<2.5		<70	
ECD50	615 165 095 0	63	<2.5		<70		EID270-410	615 165 679 0	30	<2.5		<70	
ECD70	615 165 096 0	63	<2.5		<70		EID28-677-CE13-L45-H15-W30	615 165 837 0	31				
ECP100-R	615 165 523 0	60	<2.5		<70		EID32-680-OE14-L34-H18-W40	615 165 836 0	31				
ECP10L	615 165 201 0	59	<2.5		<70		EID32-900	615 165 615 0	30	<2.5		<70	
ECP10LT	615 165 233 0	59	<2.5		<70		EID360-300	615 165 680 0	30	<2.5		<70	
ECP1500	615 165 524 0	60	<2.5		<70		EID44-1200	615 165 616 0	30	<2.5		<70	
ECP190	615 165 399 0	60	<2.5		<70		EID65-900	615 165 617 0	30	<2.5		<70	
ECP190-R	615 165 451 0	60	<2.5		<70		EID75-800	615 165 618 0	30	<2.5		<70	
ECP20L	615 165 202 0	59	<2.5		<70		ELB 12-600-P	615 165 418 0	13	<2.5		<70	
ECP20LT	615 165 234 0	59	<2.5		<70		ELB 2.5-1250-P	615 165 415 0	13	<2.5		<70	
ECP20S	615 165 203 0	59	<2.5		<70		ELB 6-670-P	615 165 440 0	13	<2.5		<70	
ECP2100	615 165 525 0	60	<2.5		<70		ELB 6-900-P	615 165 416 0	13	<2.5		<70	
ECP3000	615 165 526 0	60	<2.5		<70		ELB 8-670-P	615 165 417 0	13	<2.5		<70	
							ELC 12-600-P-Z	615 165 704 0	13	<2.5		<70	
							ELC 15-480-A-Z	615 165 708 0	13	<2.5		<70	
							ELC 30-300-A-Z	615 165 709 0	13	<2.5		<70	
							ELC 45-180-A-Z	615 165 710 0	13	<2.5		<70	

Index (Model search)

Vibration level (m/s²) - Noise level (dB(A))

All values are current as of the date of this publication. For the latest information please visit www.desouttertools.com

MODEL	PART NO.	PAGE	VIBRATION LEVEL (3 axes value) ISO 28927		NOISE LEVEL ISO 15744	SOUND LEVEL ISO 15744	MODEL	PART NO.	PAGE	VIBRATION LEVEL (3 axes value) ISO 28927		NOISE LEVEL ISO 15744	SOUND LEVEL ISO 15744
			a m/s ²	K m/s ²						a m/s ²	K m/s ²		
ELC 6-1000-P-Z	615 165 701 0	13	<2.5		<70		ERDL1.5-30	615 165 368 0	45	<2.5		<70	
ELC 7-360-A-Z	615 165 726 0	13	<2.5		<70		ERDL2-40	615 165 369 0	45	<2.5		<70	
ELC 7-880-A-Z	615 165 707 0	13	<2.5		<70		ERDL2-50	615 165 370 0	45	<2.5		<70	
ELC 8-400-P-Z	615 165 702 0	13	<2.5		<70		ERDL4-135	615 165 395 0	45	<2.5		<70	
ELC 8-800-P-Z	615 165 703 0	13	<2.5		<70		ERDL4-60	615 165 407 0	45	<2.5		<70	
ELS 12-400-P4S	615 165 826 0	13	<2.5		<70		ERDL4-80	615 165 394 0	45	<2.5		<70	
ELS 12-600-P	615 165 422 0	13	<2.5		<70		ERDL6-170	615 165 396 0	45	<2.5		<70	
ELS 15-480-A	615 165 629 0	13	<2.5		<70		ERDL6-220	615 165 397 0	45	<2.5		<70	
ELS 15-480-A4S	616 165 839 0	13	<2.5		<70		ERDL6-250	615 165 398 0	45	<2.5		<70	
ELS 2.5-1550-P	615 165 419 0	13	<2.5		<70		ERP10L	615 165 195 0	28	<2.5		<70	
ELS 30-300-A	615 165 630 0	13	<2.5		<70		ERP10LT	615 165 229 0	28	<2.5		<70	
ELS 45-180-A	615 165 631 0	13	<2.5		<70		ERP20L	615 165 196 0	28	<2.5		<70	
ELS 60-145-A	615 165 632 0	13	<2.5		<70		ERP20LT	615 165 230 0	28	<2.5		<70	
ELS 6-1000-P	615 165 420 0	13	<2.5		<70		ERP20S	615 165 197 0	28	<2.5		<70	
ELS 7-360-A4S	615 165 725 0	13	<2.5		<70		ERP30S	615 165 198 0	28	<2.5		<70	
ELS 7-880-A	615 165 628 0	13	<2.5		<70		ERP3L	615 165 193 0	28	<2.5		<70	
ELS 8-400-P	615 165 605 0	13	<2.5		<70		ERP3LT	615 165 227 0	28	<2.5		<70	
ELS 8-400-P4S	615 165 825 0	13	<2.5		<70		ERP40S	615 165 263 0	28	<2.5		<70	
ELS 8-800-P	615 165 421 0	13	<2.5		<70		ERP5L	615 165 194 0	28	<2.5		<70	
EME106-10J	615 165 437 0	49	<2.5		<70		ERP5LT	615 165 228 0	28	<2.5		<70	
EME106-20J	615 165 438 0	49	<2.5		<70		ERS12	615 165 690 0	43	<2.5		<70	
EME24-20 OF	615 165 512 0	49	<2.5		<70		ERS12-M20	615 165 693 0	43	<2.5		<70	
EME26-50 OF	615 165 513 0	49	<2.5		<70		ERS2	615 165 688 0	43	<2.5		<70	
EME30-80 OF	615 165 514 0	49	<2.5		<70		ERS2-M20	615 165 691 0	43	<2.5		<70	
EME35-10J	615 165 423 0	49	<2.5		<70		ERS6	615 165 689 0	43	<2.5		<70	
EME35-20J	615 165 424 0	49	<2.5		<70		ERS6-M20	615 165 692 0	43	<2.5		<70	
EME36-140 OF	615 165 515 0	49	<2.5		<70		ERSA-12	615 165 699 0	43	<2.5		<70	
EME38-10J	615 165 425 0	49	<2.5		<70		ERSA-2	615 165 697 0	43	<2.5		<70	
EME38-20J	615 165 426 0	49	<2.5		<70		ERSA-6	615 165 698 0	43	<2.5		<70	
EME40-180 OF	615 165 516 0	49	<2.5		<70		ERSF-12	615 165 696 0	43	<2.5		<70	
EME44-350 OF	615 165 602 0	49	<2.5		<70		ERSF-2	615 165 694 0	43	<2.5		<70	
EME51-10J	615 165 427 0	49	<2.5		<70		ERSF-6	615 165 695 0	43	<2.5		<70	
EME51-20J	615 165 428 0	49	<2.5		<70		ESP1	615 932 635 0	71				
EME60-10J	615 165 429 0	49	<2.5		<70		ESP1-HT	615 932 637 0	71				
EME60-20J	615 165 430 0	49	<2.5		<70		ESP1-A	615 932 662 0	71				
EME60-30J	615 165 431 0	49	<2.5		<70		ESP C 110 V	615 165 484 0	76				
EME80-10J	615 165 432 0	49	<2.5		<70		ESP C 220 V	615 165 480 0	76				
EME80-20J	615 165 433 0	49	<2.5		<70		ESP C LT 110 V	615 165 485 0	76				
EME80-30J	615 165 434 0	49	<2.5		<70		ESP C LT 220 V	615 165 481 0	76				
EME80-40J	615 165 435 0	49	<2.5		<70		ESP CA 110V	615 165 486 0	76				
EME80-50J	615 165 436 0	49	<2.5		<70		ESP CA 220V	615 165 482 0	76				
EMEL38-20J	615 165 517 0	49	<2.5		<70		ESP CA LT 110V	615 165 487 0	76				
EMEL51-20J	615 165 518 0	49	<2.5		<70		ESP CA LT 220V	615 165 483 0	76				
EMEL60-20J	615 165 519 0	49	<2.5		<70		FAS3000	205 146 677 4	92				
EMEL60-30J	615 165 520 0	49	<2.5		<70		Fastening accessories		150				
EMEL80-40J	615 165 521 0	49	<2.5		<70		H410-N-150	1302534	101	<2.5		82	
ERAL1.5-15	615 165 356 0	45	<2.5		<70		H410-N-350	1302454	101	<2.5		82	
ERAL1.5-25	615 165 357 0	45	<2.5		<70		H410-N-500	1302374	101	<2.5		82	
ERAL2.30	615 165 362 0	45	<2.5		<70		H410-N-60	1302794	101	<2.5		82	
ERAL2.40	615 165 363 0	45	<2.5		<70		H410-N-90	1302614	101	<2.5		82	
ERAL2-60	615 165 364 0	45	<2.5		<70		Hose Reels		273				
ERAL2-80	615 165 365 0	45	<2.5		<70		K1120B3CWY	615 170 171 0	209	<2.5		90	
ERAL2-80 SQ1/2	615 165 406 0	45	<2.5		<70		K1180-9	615 170 246 0	201	<2.5		95	101
ERAL4-110	615 165 385 0	45	<2.5		<70		K145B6	615 170 002 0	209	<2.5		75	106
ERAL4-120	615 165 386 0	45	<2.5		<70		K160B6	615 170 003 0	209	<2.5		77	
ERAL4-140	615 165 387 0	45	<2.5		<70		K160B6Y	615 170 173 0	209	<2.5		77	
ERAL4-170	615 165 388 0	45	<2.5		<70		K190B3CW	615 170 005 0	209	<2.5		82	
ERAL4-225	615 165 389 0	45	<2.5		<70		K190B3CWY	615 170 172 0	209	<2.5		82	
ERAL4-90	615 165 384 0	45	<2.5		<70		K190B4	615 170 004 0	209	<2.5		82	
ERAL6-135	615 165 390 0	45	<2.5		<70		K320-7	615 170 033 0	199	<2.5		75	
ERAL6-170	615 165 441 0	45	<2.5		<70		K320-9	615 170 142 0	203	2.4	1.2	75	
ERAL6-280	615 165 391 0	45	<2.5		<70		K325-7	615 170 034 0	199	<2.5		74	
ERAL6-350	615 165 392 0	45	<2.5		<70		K325-9	615 170 141 0	203	2.8	1.2	74	
ERAL6-480	615 165 393 0	45	<2.5		<70		K331-7	615 170 035 0	199	<2.5		80	
ERD5J	615 165 060 0	45	<2.5		<70		K331-9	615 170 140 0	203	2.2	0.9	80	
ERDL1.5-12	615 165 366 0	45	<2.5		<70		K340-7	615 170 036 0	199	<2.5		78	
ERDL1.5-20	615 165 367 0	45	<2.5		<70		K340-9	615 170 139 0	203	4.3	2.1	78	

Index (Model search)

Vibration level (m/s²) - Noise level (dB(A))

All values are current as of the date of this publication. For the latest information please visit www.desouttertools.com

MODEL	PART NO.	PAGE	VIBRATION LEVEL (3 axes value) ISO 28927		NOISE LEVEL ISO 15744 dB(A)	SOUND LEVEL ISO 15744 dB(A)	MODEL	PART NO.	PAGE	VIBRATION LEVEL (3 axes value) ISO 28927		NOISE LEVEL ISO 15744 dB(A)	SOUND LEVEL ISO 15744 dB(A)
			a m/s ²	K m/s ²						a m/s ²	K m/s ²		
K615-7	615 170 104 0	201	<2.5		76				2.9	0.9	75		
K615-9	615 170 155 0	201	2.5	1.3	76	KA312-7	615 170 037 0	199					
K619-7	615 170 105 0	201	<2.5		76	KA312-9	615 170 149 0	203	3.2	2.0	75		
K619-9	615 170 153 0	201	<2.5		76	KA312-9FE	615 170 205 0	203	3.2	2.0	78		
K624-7	615 170 106 0	201	2.6	1.5	81	KA312E7	615 170 039 0	199	3.4	1.4	77		
K624-9	615 170 151 0	201	<2.5		81	KA312E9	615 170 147 0	203	3.5	1.8	77		
K628-7	615 170 107 0	201	<2.5		85	KA312EG	615 170 040 0	225	2.7	1.2	76		
K628-9	615 170 150 0	201	2.5	1.3	85	KA312G	615 170 038 0	225	<2.5		77		
K912-7	615 170 110 0	201	<2.5		76	KA313C4	615 170 049 0	211	12	4.0	79		
K912-9	615 170 157 0	201	<2.5		76	KA313EC4	615 170 050 0	211	15	6.0	78		
K912C3	615 170 111 0	207	<2.5		81	KA318-9	615 170 461 0	203	4.1	2.1	77		
K912C4	615 170 112 0	207	<2.5		78	KA318C3	615 170 041 0	211	14.7	5.8	81		
K912D3	615 170 113 0	207	<2.5		77	KA318EC3	615 170 045 0	211	18	6.5	78		
K912-300-7	615 170 108 0	201	3.6	1.3	74	KA318G	615 170 310 0	225	2.5	1.3	77		
K912-300-9	615 170 169 0	201	3.0	1.3	74	KA320-7	615 170 043 0	199	4.7	2.4	78		
K912-500-7	615 170 109 0	201	3.3	1.7	74	KA320-9	615 170 148 0	203	4.3	2.1	78		
K912-500-9	615 170 170 0	201	3.0	1.4	74	KA320-9FE	615 170 206 0	203	4.3	2.1	80		
K915-7	615 170 114 0	201	<2.5		81	KA320C2	615 170 488 0	211	19.8	6.6	78		
K915-9	615 170 156 0	201	<2.5		81	KA320C3	615 170 042 0	211	19.8	6.6	78		
K915C25	615 170 115 0	207	<2.5		77	KA320E7	615 170 047 0	199	5.1	2.3	80		
K915C3	615 170 116 0	207	2.7	1.1	78	KA320E9	615 170 146 0	203	5.7	3.0	80		
K918-7	615 170 117 0	201	<2.5		80	KA320EC2	615 170 487 0	211	16	4.9	80		
K918-9	615 170 154 0	201	<2.5		80	KA320EC3	615 170 046 0	211	16	4.9	80		
K918C3	615 170 118 0	207	5.3	3.1	77	KA320EG	615 170 048 0	225	3.6	2.6	77		
K922-7	615 170 119 0	201	<2.5		81	KA320G	615 170 044 0	225	2.8	1.2	77		
K922-9	615 170 152 0	201	<2.5		81	KA613EC4	615 170 138 0	211	7.2	2.4	84		
KA16060A	615 170 449 0	227	3.3	1.6	77	KA613-9	615 170 135 0	203	3.7	1.4	85		
KA16060B	615 170 453 0	227	3.3	1.6	77	KA613C4	615 170 137 0	211	9.3	3.0	85		
KA16060BY	615 170 451 0	227	3.3	1.6	76	KA613E9	615 170 136 0	203	4.9	2.6	83		
KA16075A	615 170 448 0	227	3.3	1.6	80	KA9020A	615 170 096 0	229	<2.5		80		
KA16075B	615 170 452 0	227	3.3	1.6	79	KA9020B	615 170 097 0	229	<2.5		80		
KA16075BY	615 170 450 0	227	3.3	1.6	78	KA9030A	615 170 098 0	229	2.6	1.3	83		
KA16085A	615 170 468 0	227	3.4	1.7	80	KA9030B	615 170 099 0	229	2.6	1.3	83		
KA16085B	615 170 469 0	227	3.4	1.7	80	KA9030BY	615 170 309 0	229	2.6	1.3	82		
KA16100B6FVK	615 170 470 0	217	5.2	1.5	82	KC061000	205 146 638 4	197	<2.5		71		
KA16120-9	615 170 443 0	201	5.0	3.1	82	KC1600	615 170 315 0	197	<2.5		71		
KA16120A	615 170 435 0	227	2.9	1.5	85	KC1600-T	615 170 313 0	197	<2.5		71		
KA16120A45	615 170 455 0	213	7.8	4.6	82	KC318-9	615 170 196 0	203	3.4	1.5	72		
KA16120A45VK	615 170 456 0	213	4.7	1.1	79	KC320-7	615 170 029 0	199	<2.5		74		
KA16120A5	615 170 437 0	215	7.1	2.2	82	KC320-9	615 170 027 0	203	3.1	1.9	74		
KA16120A5VK	615 170 438 0	215	4.7	2.0	79	KC325-7	615 170 030 0	199	<2.5		78		
KA16120B	615 170 445 0	227	2.9	1.5	85	KC325-9	615 170 145 0	203	3.0	1.4	78		
KA16120B45	615 170 457 0	213	7.8	4.6	82	KC331-7	615 170 031 0	199	2.8	2.0	77		
KA16120B45VK	615 170 458 0	213	4.4	2.5	79	KC331-9	615 170 144 0	203	3.4	1.5	77		
KA16120B5	615 170 439 0	215	7.5	2.5	82	KC340-7	615 170 032 0	199	2.8	2.0	77		
KA16120B5VK	615 170 454 0	215	4.7	1.1	79	KC340-9	615 170 143 0	203	3.9	1.8	77		
KA16120BY	615 170 447 0	227	2.9	1.5	86	KC615-7	615 170 123 0	201	<2.5		74		
KA16120H5	615 170 444 0	215	7.9	2.3	82	KC615-9	615 170 163 0	201	3.4	2.0	74		
KA16120H5K	615 170 434 0	215	7.8	3.0	79	KC619-7	615 170 124 0	201	<2.5		74		
KA16135C4FK	615 170 441 0	213	16.7	5.0	82	KC619-9	615 170 161 0	201	3.1	1.8	74		
KA16135C4S	615 170 446 0	227	4.8	3.6	85	KC624-7	615 170 125 0	201	<2.5		82		
KA26060BY	615 170 481 0	231	<2.5		86	KC624-9	615 170 159 0	201	<2.5		89		
KA26065B9V	615 170 477 0	221	5.4	1.0	93	KC624-9RT	615 170 290 0	204	<2.5		82		
KA26065BV	615 170 480 0	231	<2.5		89	KC628-7	615 170 126 0	201	<2.5		85		
KA26065H9V	615 170 490 0	221	5.4	1.0	93	KC628-9	615 170 158 0	201	<2.5		82		
KA26077B7Y	615 170 478 0	219	5.3	1.1	84	KC9010-7	615 170 120 0	223	<2.5		84		
KA26077BY	615 170 482 0	231	3.6	0.8	84	KC9010-9	615 170 168 0	223	<2.5		82		
KA26085B7V	615 170 476 0	219	5.7	1.1	87	KC9035-7	615 170 121 0	223	<2.5		82		
KA26085BV	615 170 479 0	231	<2.5		87	KC9035-9	615 170 167 0	223	<2.5		82		
KA26085H7V	615 170 489 0	219	5.7	1.1	87	KC9060-7	615 170 122 0	223	<2.5		83		
KA3.135-7	615 170 515 0	199	3.9		81	KC9060-9	615 170 166 0	223	<2.5		83		
KA3.21-7	615 170 517 0	225	<2.5		80	KC912-7	615 170 127 0	201	<2.5		75		
KA3.36-7	615 170 516 0	225	3.1		80	KC912-9	615 170 165 0	201	<2.5		75		
KA3.36A	615 170 518 0	225	<2.5		80	KC912D3	615 170 491 0	207	<2.5		81		
KA309-9	615 170 266 0	203	2.8	1.6	76	KC915-7	615 170 128 0	201	<2.5		80		
KA309C	615 170 203 0	225	8.1	1.3	76	KC915-9	615 170 164 0	201	3.9	2.2	80		
KA309G	615 170 204 0	225	<2.5		77	KC918-7	615 170 129 0	201	<2.5		81		
						KC918-9	615 170 162 0	201	2.9	1.8	81		

Index (Model search)

Vibration level (m/s²) - Noise level (dB(A))

All values are current as of the date of this publication. For the latest information please visit www.desouttertools.com

MODEL	PART NO.	PAGE	VIBRATION LEVEL (3 axes value) ISO 28927		NOISE LEVEL ISO 15744	SOUND LEVEL ISO 15744	MODEL	PART NO.	PAGE	VIBRATION LEVEL (3 axes value) ISO 28927		NOISE LEVEL ISO 15744	SOUND LEVEL ISO 15744
			a m/s ²	K m/s ²						a m/s ²	K m/s ²		
KC922-7	615 170 130 0	201	<2.5		81		RFD-100-330	680244	185	<2.5		88	
KC922-9	615 170 160 0	201	3.5	2.4	81		RFD-100-500	680164	185	<2.5		88	
KL1120A5	615 170 013 0	217	6.8	2.5	84		RFD-100-60	1457384	185	<2.5		88	
KL165B	615 170 011 0	231	<2.5		77		RFD-100-800	680084	185	<2.5		88	
KL177B7Y	615 170 182 0	219	6.7	2.1	91		RFD-100-85	1457374	185	<2.5		88	
KL185B7	615 170 012 0	219	6.7	2.1	78		RFDT-125-140	1445504	185	<2.5		88	
KL360B9Y	615 170 350 0	221	4.0	1.8	85		RFDT-125-330	1445674	185	<2.5		88	
KL365B9	615 170 338 0	221	4.6	1.4	87		RFDT-125-500	1445664	185	<2.5		88	
KL365B9V	615 170 474 0	221	<2.5		87		RFDT-125-60	1445524	185	<2.5		88	
KL377B7	615 170 341 0	219	5.1	1.5	88		RFDT-125-800	1445654	185	<2.5		88	
MC35-10	615 165 107 0	65	<2.5		<70		RFDT-125-85	1445514	185	<2.5		88	
MC35-20	615 165 108 0	65	<2.5		<70		RS500-P18500	205 148 130 4	183	<2.5		78	
MC38-10	615 165 109 0	65	<2.5		<70		RS500-P18500	205 148 129 4	183	<2.5		78	
MC38-20	615 165 110 0	65	<2.5		<70		Routers		204				
MC51-10	615 165 111 0	65	<2.5		<70		S144-T3100	936974	259	<2.5		80	
MC51-20	615 165 112 0	65	<2.5		<70		SB011-AB1600-S4Q	1460644	88	<2.5		69	
Measurement accessories		121					SB011-AR1600-S4Q	1460524	88	<2.5		69	
Multicombox	615 929 044 0	48					SB015-AB1100-S4Q	1460634	88	<2.5		69	
Multiplus		126					SB015-AR1100-S4Q	1460514	88	<2.5		69	
PL05-10D	615 170 131 0	253	<2.5		80		SB021-LR1400-S4Q	205 147 508 4	89	<2.5		72	
PL05-10E	615 170 132 0	253	<2.5		80		SB021-LR2000-S4Q	205 147 509 4	89	<2.5		72	
PL05-10F	615 170 133 0	253	<2.5		80		SB025-AB500-S4Q	1460684	88	<2.5		69	
Posco 500		66					SB025-AB750-S4Q	1460624	88	<2.5		69	
Posco Vision		67					SB025-AR500-S4Q	1460564	88	<2.5		69	
PT010-L5000-S4Q	205 146 225 4	110	4.7	2.3	70		SB025-AR750-S4Q	1460504	88	<2.5		69	
PT010-T5000-S4Q	205 146 227 4	110	3.5	1.6	73		SB043-LR1050-S4Q	205 147 507 4	89	<2.5		72	
PT014-L6000-S4Q	205 146 226 4	110	4.7	2.1	73		SB047-LR500-S4Q	205 147 506 4	89	<2.5		72	
PT014-T6000-S4Q	205 146 228 4	110	3.0	2.2	70		SBP021-T1600-S4Q	1462154	90	<2.5		73	
PT025-L4500-S10S	205 147 463 4	110	7.4	4.2	75		SBP021-T2300-S4Q	1462144	90	<2.5		73	
PT025-T4500-S10S	205 147 462 4	110	6.3	3.4	76		SBP022-T1600-R4Q	1462194	95	<2.5		73	
PT028-T9000-I4Q	205 147 789 4	110	4.3	2.9	72		SBP024-T2300-R4Q	1462184	95	<2.5		73	
PT031-L10000-I10S	205 147 466 0	110	4.7	2.1	73		SBP043-T1100-S4Q	1462164	90	<2.5		73	
PT031-T9000-I10S	205 147 467 4	110	5.2	4.5	75		SBP044-T1100-R4Q	1462204	95	<2.5		73	
PT035-T6000-S4Q	205 147 790 4	110	6.1	2.2	74		SBP044-T550-R4Q	1462214	95	<2.5		73	
PT040-T6000-S10S	205 146 229 4	110	6.3	2.5	77		SBP047-T550-S4Q	1462174	90	<2.5		73	
PT052-T7000-I10S	205 147 468 4	110	3.7	2.2	80		SC009-L1600-HLT4M	1459644	91	<2.5		73	
PT070-T4000-S13S	205 146 230 4	110	5.8	2.2	82		SC021-L1400-S90A4H	1459064	98	<2.5		73	
PT070-T6000-I13S	205 147 469 4	110	4.9	2.7	48		SC021-L1400-S90A4S	1459144	98	<2.5		73	
PT110-T4500-I13S	205 147 470 4	110	8.1	2.7	79		SC021-L1600-HLT4M	1459614	91	<2.5		73	
PT125-T3500-S13S	205 146 231 4	110	7.2	2.4	79		SC021-L2000-S90A4H	1459074	98	<2.5		73	
PT160-T3500-I13S	205 147 471 4	110	9.3	4.2	79		SC021-L2000-S90A4S	1459154	98	<2.5		73	
PT240-T2800-I19S	205 147 472 4	110	8.9	4.2	81		SC022-L1100-HLT4M	1459654	91	<2.5		73	
PT250-T4000-S19S	205 147 464 4	110	8.5	1.8	80		SC022-L1400-R90A4H	1459104	100	<2.5		73	
PT450-T3000-S19S	205 147 465 4	110	11.2	4.1	85		SC022-L1400-R90A4S	1459184	100	<2.5		73	
PTF012-T6200-S10S	615 172 081 0	108	<2.5		75		SC022-L550-HLT4M	1459664	91	<2.5		73	
PTF012-T6200-S4Q	615 172 104 0	108	<2.5		75		SC024-L2000-R90A4H	1459114	100	<2.5		73	
PTF012-T6500-S4Q	615 172 105 0	108	<2.5		79		SC024-L2000-R90A4S	1459194	100	<2.5		73	
PTF020-T6700-I4Q	615 172 101 0	108	<2.5		76		SC043-L1100-HLT4M	1459624	91	<2.5		73	
PTF024-T6500-S10S	615 172 084 0	108	<2.5		79		SC043-L950-S90A4H	1459054	98	<2.5		73	
PTF024-T6700-I10S	615 172 072 0	108	<2.5		76		SC043-L950-S90A4S	1459134	98	<2.5		73	
PTF028-T6300-I4Q	615 172 102 0	108	<2.5		79		SC044-L500-R90A4H	1459084	100	<2.5		73	
PTF028-T6300-S4Q	615 172 106 0	108	<2.5		79		SC044-L500-R90A4S	1459164	100	<2.5		73	
PTF035-T6300-S10S	615 172 087 0	108	<2.5		79		SC044-L950-R90A4H	1459094	100	<2.5		73	
PTF035-T6700-I4Q	615 172 103 0	108	<2.5		82		SC044-L950-R90A4S	1459174	100	<2.5		73	
PTF040-T6300-I10S	615 172 074 0	108	<2.5		79		SC047-L500-S90A4H	1459044	98	<2.5		73	
PTF056-T6700-I10S	615 172 075 0	108	<2.5		82		SC047-L500-S90A4S 1	459124	98	<2.5		73	
PTF060-T6100-I10S	615 172 076 0	108	<2.5		84		SC047-L550-HLT4M	1459634	91	<2.5		73	
PTF060-T6100-S10S	615 172 088 0	108	<2.5		79		SC2-025-1AM2200-S4Q	205 147 426 4	103	<2.5		71	
PTF085-T4800-S13S	615 172 089 0	108	3.7	1.5	81		SC2-025-2RM2200-S4Q	205 147 440 4	103	<2.5		71	
PTF096-T4600-I13S	615 172 077 0	108	3.4	1.3	79		SC2-025-A2200-R4Q	205 147 276 4	94	<2.5		71	
PTF130-T4500-S13S	615 172 090 0	108	3.9	1.8	85		SC2-025-A2200-S4Q	205 147 269 4	88	<2.5		71	
PTF136-T5000-I13S	615 172 078 0	108	<2.5		85		SC2-025-L2200-R4Q	205 147 290 4	94	<2.5		71	
PTF165-T3400-S13S	615 172 091 0	108	4.9	2.4	83		SC2-025-L2200-S4Q	205 147 283 4	89	<2.5		71	
PTF172-T3800-I13S	615 172 079 0	108	4.1	2.1	84		SC2-035-1AM1500-S4Q	205 147 425 4	103	<2.5		71	
RFD-100-140	145364	185	<2.5		88		SC2-035-2RM1500-S4Q	205 147 439 4	103	<2.5		71	
RFD-100-1850	681394	185	<2.5		88		SC2-035-A1500-R4Q	205 147 275 4	94	<2.5		71	
RFD-100-2800	681214	185	<2.5		90		SC2-035-A1500-S4Q	205 147 268 4	88	<2.5		71	

Index (Model search)

Vibration level (m/s²) - Noise level (dB(A))

All values are current as of the date of this publication. For the latest information please visit www.desouttertools.com

MODEL	PART NO.	PAGE	VIBRATION LEVEL (3 axes value) ISO 28927		NOISE LEVEL ISO 15744	SOUND LEVEL ISO 15744	MODEL	PART NO.	PAGE	VIBRATION LEVEL (3 axes value) ISO 28927		NOISE LEVEL ISO 15744	SOUND LEVEL ISO 15744
			a m/s ²	K m/s ²						a m/s ²	K m/s ²		
SC2-035-L1500-R4Q	205 147 289 4	94	<2.5		71		SD023-LR3500-S4Q	1463024	89	<2.5		73	
SC2-035-L1500-S4Q	205 147 282 4	89	<2.5		71		SD035-1AM2200-S4Q	1464244	103	<2.5		73	
SC2-045-1AM1000-S4Q	205 147 424 4	103	<2.5		71		SD035-2RM2200-S4Q	1464314	103	<2.5		73	
SC2-045-2RM1000-S4Q	205 147 438 4	103	<2.5		71		SD035-AB2200-R4Q	1462944	94	<2.5		73	
SC2-045-A1000-R4Q	205 147 274 4	94	<2.5		71		SD035-AB2200-S4Q	1462824	88	<2.5		73	
SC2-045-A1000-S4Q	205 147 267 4	88	<2.5		71		SD035-AR2200-R4Q	1462884	94	<2.5		73	
SC2-045-L1000-R4Q	205 147 288 4	94	<2.5		71		SD035-AR2200-S4Q	1462754	88	<2.5		73	
SC2-045-L1000-S4Q	205 147 281 4	89	<2.5		71		SD035-LB2200-R4Q	1463204	94	<2.5		73	
SC2-055-1AM700-S4Q	205 147 423 4	103	<2.5		71		SD035-LB2200-S4Q	1463084	89	<2.5		73	
SC2-055-2RM700-S4Q	205 147 437 4	103	<2.5		71		SD035-LR2200-R4Q	1463144	94	<2.5		73	
SC2-055-A700-R4Q	205 147 273 4	94	<2.5		71		SD035-LR2200-S4Q	1463014	89	<2.5		73	
SC2-055-A700-S4Q	205 147 266 4	88	<2.5		71		SD055-1AM1470-S4Q	1464234	103	<2.5		73	
SC2-055-L700-R4Q	205 147 287 4	94	<2.5		71		SD055-2RM1470-S4Q	1464304	103	<2.5		73	
SC2-055-L700-S4Q	205 147 280 4	89	<2.5		71		SD055-AB1470-R4Q	1462934	94	<2.5		73	
SC2-065-1AM500-S4Q	205 147 422 4	103	<2.5		71		SD055-AB1470-S4Q	1462814	88	<2.5		73	
SC2-065-2RM500-S4Q	205 147 436 4	103	<2.5		71		SD055-AR1470-R4Q	1462874	94	<2.5		73	
SC2-065-A500-R4Q	205 147 272 4	94	<2.5		71		SD055-AR1470-S4Q	1462744	88	<2.5		73	
SC2-065-A500-S4Q	205 147 265 4	88	<2.5		71		SD055-LB1470-R4Q	1463194	94	<2.5		73	
SC2-065-L500-R4Q	205 147 286 4	94	<2.5		71		SD055-LB1470-S4Q	1463074	89	<2.5		73	
SC2-065-L500-S4Q	205 147 279 4	89	<2.5		71		SD055-LR1470-R4Q	1463134	94	<2.5		73	
SC2P	615 170 077 0	247	4.6	2.6	81		SD055-LR1470-S4Q	1463004	89	<2.5		73	
SC2P14	615 170 083 0	247	4.6	2.6	85		SD070-LB1100-R90-A4H	1463334	100	<2.5		73	
SC2P8	615 170 089 0	247	4.6	2.6	82		SD070-LB1100-R90-A4S	1463454	100	<2.5		73	
SC3P	615 170 079 0	247	3.7	2.0	79		SD070-LB1100-S90-A4H	1463254	98	<2.5		73	
SC3P14	615 170 085 0	247	3.7	2.0	83		SD070-LB1100-S90-A4S	1463374	98	<2.5		73	
SC3P8	615 170 091 0	247	3.7	2.0	82		SD070-LB320-R90-A4H	1463304	100	<2.5		73	
SC4	615 170 081 0	247	5.4	2.8	80		SD070-LB320-R90-A4S	1463424	100	<2.5		73	
SC4-14	615 170 087 0	247	5.4	2.8	82		SD070-LB320-S90-A4H	1463224	98	<2.5		73	
SC4-8	615 170 093 0	247	5.4	2.8	83		SD070-LB320-S90-A4S	1463344	98	<2.5		73	
SC4P	615 170 078 0	247	2.7	1.6	81		SD070-LB510-R90-A4H	1463314	100	<2.5		73	
SC4P14	615 170 084 0	247	2.7	1.6	84		SD070-LB510-R90-A4S	1463434	100	<2.5		73	
SC4P8	615 170 090 0	247	2.7	1.6	82		SD070-LB510-S90-A4H	1463234	98	<2.5		73	
SCBP021-T1600-S4Q	1466364	90	<2.5		73		SD070-LB510-S90-A4S	1463354	98	<2.5		73	
SCBP021-T2300-S4Q	1466374	90	<2.5		73		SD070-LB820-R90-A4H	1463324	100	<2.5		73	
SCBP043-T1100-S4Q	1466354	90	<2.5		73		SD070-LB820-R90-A4S	1463444	100	<2.5		73	
SCBP044-T740-S4Q	1466344	90	<2.5		73		SD070-LB820-S90-A4H	1463244	98	<2.5		73	
SCBP047-T550-S4Q	1466334	90	<2.5		73		SD070-LB820-S90-A4S	1463364	98	<2.5		73	
SCP009-T1600-HLT4M	1459704	91	<2.5		73		SD070-LR1100-R90-A4H	1463654	100	<2.5		73	
SCP021-T1600-HLT4M	1459714	91	<2.5		73		SD070-LR1100-R90-A4S	1463694	100	<2.5		73	
SCP021-T1600-S4Q	1456744	90	<2.5		73		SD070-LR1100-S90-A4H	1463294	98	<2.5		73	
SCP021-T2300-S4Q	1456734	90	<2.5		73		SD070-LR1100-S90-A4S	1463414	98	<2.5		73	
SCP022-T1100-HLT4M	1459724	91	<2.5		73		SD070-LR160-S90-A4S	205 146 705 4	98	<2.5		73	
SCP022-T1600-R4Q	1456784	95	<2.5		73		SD070-LR320-R90-A4H	1463624	100	<2.5		73	
SCP022-T550-HLT4M	1459744	91	<2.5		73		SD070-LR320-R90-A4S	1463664	100	<2.5		73	
SCP024-T2300-R4Q	1456774	95	<2.5		73		SD070-LR320-S90-A4H	1463264	98	<2.5		73	
SCP043-T1100-HLT4M	1459734	91	<2.5		73		SD070-LR320-S90-A4S	1463284	98	<2.5		73	
SCP043-T1100-S4Q	1456754	90	<2.5		73		SD070-LR510-R90-A4H	1463634	100	<2.5		73	
SCP044-T1100-R4Q	1456794	95	<2.5		73		SD070-LR510-R90-A4S	1463674	100	<2.5		73	
SCP044-T550-R4Q	1456804	95	<2.5		73		SD070-LR510-S90-A4H	1463274	98	<2.5		73	
SCP047-T550-HLT4M	1459754	91	<2.5		73		SD070-LR510-S90-A4S	1463394	98	<2.5		73	
SCP047-T550-S4Q	1456764	90	<2.5		73		SD070-LR820-R90-A4H	1463644	100	<2.5		73	
SCPT021-A1600-S4Q	1458934	90	<2.5		73		SD070-LR820-R90-A4S	1463684	100	<2.5		73	
SCPT021-A2300-S4Q	1458974	90	<2.5		73		SD070-LR820-S90-A4H	1463284	98	<2.5		73	
SCPT022-A1600-R4Q	1458954	95	<2.5		73		SD070-LR820-S90-A4S	1463404	98	<2.5		73	
SCPT024-A2300-R4Q	1458994	95	<2.5		73		SD072-LB1080-S90-A10S	1463504	98	<2.5		73	
SCPT043-A1100-S4Q	1458894	90	<2.5		73		SD075-1AM1100-S4Q	1464224	103	<2.5		73	
SCPT044-A1100-R4Q	1458914	95	<2.5		73		SD075-2RM1100-S4Q	1464294	103	<2.5		73	
SCPT047-A550-S4Q	1458854	90	<2.5		73		SD075-AB1100-R4Q	1462924	94	<2.5		73	
SD023-1AM3500-S4Q	1464254	103	<2.5		73		SD075-AB1100-S4Q	1462804	88	<2.5		73	
SD023-2RM3500-S4Q	1464324	103	<2.5		73		SD075-AR1100-R4Q	1462864	94	<2.5		73	
SD023-AB3500-R4Q	1462954	94	<2.5		73		SD075-AR1100-S4Q	1462734	88	<2.5		73	
SD023-AB3500-S4Q	1462834	88	<2.5		73		SD075-LA1100-S4	1464604	96	<2.5		73	
SD023-AR3500-R4Q	1462894	94	<2.5		73		SD075-LB1100-R4Q	1463184	94	<2.5		73	
SD023-AR3500-S4Q	1462764	88	<2.5		73		SD075-LB1100-S4Q	1463064	89	<2.5		73	
SD023-LB3500-R4Q	1463214	94	<2.5		73		SD075-LR1100-R4Q	1463124	94	<2.5		73	
SD023-LB3500-S4Q	1463094	89	<2.5		73		SD075-LR1100-S4Q	1462994	89	<2.5		73	
SD023-LR3500-R4Q	1463154	94	<2.5		73								

Index (Model search)

Vibration level (m/s²) - Noise level (dB(A))

All values are current as of the date of this publication. For the latest information please visit www.desouttertools.com

MODEL	PART NO.	PAGE	VIBRATION LEVEL (3 axes value) ISO 28927		NOISE LEVEL ISO 15744	SOUND LEVEL ISO 15744	MODEL	PART NO.	PAGE	VIBRATION LEVEL (3 axes value) ISO 28927		NOISE LEVEL ISO 15744	SOUND LEVEL ISO 15744
			a m/s ²	K m/s ²						a m/s ²	K m/s ²		
SD095-LB800-S90-A10S	1463494	98	<2.5		73		SDP075-T1050-S4Q	1465544	90	<2.5		75	
SD095-LR800-S90-A10S	1463544	98	<2.5		73		SDP100-T300-R4Q	1465584	95	<2.5		75	
SD096-LB800-D90-A4S	1465984	101	<2.5		73		SDP100-T490-R4Q	1465594	95	<2.5		75	
SD097-LB1080-R90-A10S	1463584	100	<2.5		73		SDP100-T700-S4Q	1465534	90	<2.5		75	
SD097-LR1080-R90-A10S	1463724	100	<2.5		73		SDP100-T780-D4Q	1465674	96	<2.5		75	
SD100-1AM820-S4Q	1464214	103	<2.5		73		SDP100-T780-R4Q	1465604	95	<2.5		75	
SD100-2RM820-S4Q	1464284	103	<2.5		73		SDP140-T490-D4Q	1465664	96	<2.5		75	
SD100-AB510-R4Q	1462904	94	<2.5		73		SDP140-T490-S4Q	1465524	90	<2.5		75	
SD100-AB820-R4Q	1462914	94	<2.5		73		SDP160-T300-S4Q	1465514	90	<2.5		75	
SD100-AB820-S4Q	1462794	88	<2.5		73		SDT023-T3500-R4Q	205 147 635 4	95	<2.5		75	
SD100-AR510-R4Q	1462844	94	<2.5		73		SDT023-T3500-S4Q	1465784	90	<2.5		75	
SD100-AR820-R4Q	1462854	94	<2.5		73		SDT035-T1100-S4Q 205	205 147 623 4	90	<2.5		75	
SD100-AR820-S4Q	1462724	88	<2.5		73		SDT035-T2200-R4Q	205 147 636 4	95	<2.5		75	
SD100-LB510-R4Q	1463164	94	<2.5		73		SDT035-T2200-S4Q	1465774	90	<2.5		75	
SD100-LB820-R4Q	1463174	94	<2.5		73		SDT055-T1470-R4Q	205 147 637 4	95	<2.5		75	
SD100-LB820-S4Q	1463054	89	<2.5		73		SDT055-T1470-S4Q	1465764	90	<2.5		75	
SD100-LR510-R4Q	1463104	94	<2.5		73		SDT075-T1100-R4Q	205 147 638 4	95	<2.5		75	
SD100-LR820-R4Q	1463114	94	<2.5		73		SDT075-T1100-S4Q	1465754	90	<2.5		75	
SD100-LR820-S4Q	1462984	89	<2.5		73		SDT100-T320-R4Q	205 147 641 4	95	<2.5		75	
SD110-LX450	205 148 131 4	101	<2.5		73		SDT100-T510-R4Q	205 147 644 4	95	<2.5		75	
SD130-LB500-D90-A4S	1465974	101	<2.5		73		SDT100-T820-R4Q	205 147 639 4	95	<2.5		75	
SD130-LB600-R90-A10S	1463574	100	<2.5		73		SDT100-T820-S4Q	1465744	90	<2.5		75	
SD130-LB600-S90-A10S	1463484	98	<2.5		73		SDT140-T510-S4Q	1465734	90	<2.5		75	
SD130-LR600-R90-A10S	1463714	100	<2.5		73		SDT160-T320-S4Q	1465724	90	<2.5		75	
SD130-LR600-S90-A10S	1463534	98	<2.5		73		SH150-LR580-S90-A10S	205 147 629 4	99	<2.5		80	
SD140-1AM510-S4Q	1464204	103	<2.5		73		SH200-LR550-S90-A10S	205 147 630 4	99	<2.5		80	
SD140-2RM510-S4Q	1464274	103	<2.5		73		SH280-LR350-S90-A10S	205 147 631 4	99	<2.5		80	
SD140-AB510-S4Q	1462784	88	<2.5		73		SH280-LR80-S90-A10S	205 147 632 4	99	<2.5		80	
SD140-AR510-S4Q	1462714	88	<2.5		73		SH330-LB330-OE11-CC53	205 147 818 4	102				
SD140-LA510-S4	1464584	96	<2.5		73		SH330-LB330-OE11-CC75	205 147 819 4	102				
SD140-LB510-S4Q	1463044	89	<2.5		73		SH330-LB330-OE13-CC53	205 147 820 4	102				
SD140-LR510-S4Q	1462974	89	<2.5		73		SH330-LB330-OE13-CC75	205 147 821 4	102				
SD160-1AM320-S4Q	1464194	103	<2.5		73		SH330-LB430-CE13-CC53	205 147 815 4	102				
SD160-2RM320-S4Q	1464264	103	<2.5		73		SH410-LB400-CE17-CC68	205 147 817 4	102				
SD160-AB320-S4Q	1462774	88	<2.5		73		SH420-LR190-S90-A13S	205 147 800 4	99	<2.5		80	
SD160-AR320-S4Q	1462704	88	<2.5		73		SH500-LR330-S90-A13S	205 147 473 4	99	<2.5		80	
SD160L-AR320-S4Q	205 147 799 4	96	<2.5		73		SH700-LR225-S90-A13S	205 147 474 4	99	<2.5		80	
SD160-LB240-S-OE	1464474	102	<2.5		73		SH70-LR1100-S90-A4S	205 147 628 4	99	<2.5		80	
SD160-LB240-S-OE10-CC80	1463734	102	<2.5		73		SH850-LR190-S90-A13S	205 147 475 4	99	<2.5		80	
SD160-LB240-S-OE12-CC80	1463614	102	<2.5		73		SH1200-LR215-S90-A13S	205 147 476 4	99	<2.5		<70	
SD160-LB240-S-OE13-CC80	1463604	102	<2.5		73		SH2000-LR100-S90-A13S	205 147 801 4	99	<2.5		<70	
SD160-LB240-S-OE17-CC92	1463594	102	<2.5		73		SLB003-L1000-S4Q	615 165 625 0	73	<2.5		<70	
SD160-LB320-S4Q	1463034	89	<2.5		73		SLB012-A1000-S4Q	615 165 568 0	73	<2.5		<70	
SD160-LR320-S4Q	1462964	89	<2.5		73		SLB012-A1000-S4Q-NE	615 165 716 0	73	<2.5		<70	
SD209-LB370-R90-A10S	1463564	100	<2.5		73		SLB012-A2000-S4Q	615 165 569 0	73	<2.5		<70	
SD209-LB370-S90-A10S	1463474	98	<2.5		73		SLB012-A2000-S4Q-NE	615 165 717 0	73	<2.5		<70	
SD209-LR370-R90-A10S	1463704	100	<2.5		73		SLB012-L1000-S4Q	615 165 565 0	73	<2.5		<70	
SD209-LR370-S90-A10S	1463524	98	<2.5		73		SLB012-L1000-S4Q-NE	615 165 713 0	73	<2.5		<70	
SD220-LR320-S4Q 2	205 147 937 4	97	<2.5		78		SLB012-L2000-S4Q	615 165 566 0	73	<2.5		<70	
SD220-LR320-S10S	205 147 979 4	97	<2.5		78		SLB012-L2000-S4Q-NE	615 165 714 0	73	<2.5		<70	
SD220-2RM320-S4Q	205 147 939 4	97	<2.5		78		SLB020-A1000-S4Q	615 165 570 0	73	<2.5		<70	
SD220-2RM320-S10S	205 147 941 4	97	<2.5		78		SLB020-A1000-S4Q-NE	615 165 718 0	73	<2.5		<70	
SD300-LB250-S90-A10S	1463464	98	<2.5		73		SLB020-L1000-S4Q	615 165 567 0	73	<2.5		<70	
SD300-LR180-S90-A10S	205 146 704 4	98	<2.5		73		SLB020-L1000-S4Q-NE	615 165 715 0	73	<2.5		<70	
SD300-LR250-S90-A10S	1463514	98	<2.5		73		SLB030-A1000-S4Q	615 165 622 0	73	<2.5		<70	
SDP023-T3400-D4Q	1465714	96	<2.5		75		SLB030-A1000-S4Q-NE	615 165 722 0	73	<2.5		<70	
SDP023-T3400-R4Q	1465644	95	<2.5		75		SLB030-A2000-S4Q	615 165 623 0	73	<2.5		<70	
SDP023-T3400-S4Q	1465574	90	<2.5		73		SLB030-A2000-S4Q-NE	615 165 723 0	73	<2.5		<70	
SDP035-T2100-D4Q	1465704	96	<2.5		75		SLB030-L1000-S4Q	615 165 619 0	73	<2.5		<70	
SDP035-T2100-R4Q	1465634	95	<2.5		75		SLB030-L1000-S4Q-NE	615 165 720 0	73	<2.5		<70	
SDP035-T2100-S4Q	1465564	90	<2.5		73		SLB030-L2000-S4Q	615 165 620 0	73	<2.5		<70	
SDP045-T180-S4Q 205	205 146 706 4	90	<2.5		75		SLB030-L2000-S4Q-NE	615 165 719 0	73	<2.5		<70	
SDP055-T1400-D4Q	1465694	96	<2.5		75		SLB050-A1000-S4Q	615 165 624 0	73	<2.5		<70	
SDP055-T1400-R4Q	1465624	95	<2.5		75		SLB050-A1000-S4Q-NE	615 165 724 0	73	<2.5		<70	
SDP055-T1400-S4Q	1465554	90	<2.5		75		SLB050-L1000-S4Q	615 165 621 0	73	<2.5		<70	
SDP075-T1050-D4Q	1465684	96	<2.5		75		SLB050-L1000-S4Q-NE	615 165 721 0	73	<2.5		<70	
SDP075-T1050-R4Q	1465614	95	<2.5		75		SLC030-F1200-C4Q	615 165 490 0	78	<2.5		<70	

Index (Model search)

Vibration level (m/s²) - Noise level (dB(A))

All values are current as of the date of this publication. For the latest information please visit www.desouttertools.com

MODEL	PART NO.	PAGE	VIBRATION LEVEL (3 axes value) ISO 28927		NOISE LEVEL ISO 15744 dB(A)	SOUND LEVEL ISO 15744 dB(A)	MODEL	PART NO.	PAGE	VIBRATION LEVEL (3 axes value) ISO 28927		NOISE LEVEL ISO 15744 dB(A)	SOUND LEVEL ISO 15744 dB(A)
			a m/s ²	K m/s ²						a m/s ²	K m/s ²		
SLC030-L1200-C4Q	615 165 500 0	77	<2.5		<70		SXRB50	615 170 300 0	241	4.3	1.5	76	
SLC030-L1200-C90A4H	615 165 478 0	77	<2.5		<70		SXRB50C	615 170 216 0	241	3.9	1.4	78	
SLC030-P1200-C4Q	615 165 488 0	78	<2.5		<70		SXRB50V	615 170 213 0	241	3.2	1.7	85	
SLC030-T1200-C4Q	615 165 489 0	78	<2.5		<70		SXRB60	615 170 211 0	241	3.4	1.7	76	
SLC100-F600-C4Q	615 165 468 0	78	<2.5		<70		SXRB60	615 170 317 0	241	3.4	1.7	76	
SLC100-L600-C4Q	615 165 466 0	77	<2.5		<70		SXRB60C	615 170 217 0	241	5.7	2.9	78	
SLC100-L600-C90A4H	615 165 479 0	77	<2.5		<70		SXRB60H	615 170 355 0	243	5.1	2.5	76	
SLC100-P600-C4Q	615 165 462 0	78	<2.5		<70		SXRB60H	615 170 356 0	243	5.1	2.5	76	
SLC100-T600-C4Q	615 165 464 0	78	<2.5		<70		SXRB60HC	615 170 362 0	243	4.4	1.9	78	
SLC150-F320-C4Q	615 165 469 0	78	<2.5		<70		SXRB60HV	615 170 359 0	243	5.6	1.9	85	
SLC150-L320-C4Q	615 165 467 0	77	<2.5		<70		SXRB60V	615 170 214 0	241	4.4	1.5	85	
SLC150-P320-C4Q	615 165 463 0	78	<2.5		<70		SXRC60	615 170 462 0	241	3.4	1.7	76	
SLC150-T320-C4Q	615 165 465 0	78	<2.5		<70		SXRC60C	615 170 463 0	241	5.7	2.9	78	
SLK003-L1000-S4Q	615 165 252 0	75	<2.5		<70		SXRC60H	615 170 465 0	243	5.1	2.5	76	
SLK007-L1000-S4Q	615 165 253 0	75	<2.5		<70		SXRC60HC	615 170 466 0	243	4.4	1.9	78	
SLK010-L670-S4Q	615 165 254 0	75	<2.5		<70		SXRC60HV	615 170 467 0	243	5.6	1.9	85	
SLK011-A1000-S4Q	615 165 257 0	75	<2.5		<70		SXRC60V	615 170 464 0	241	4.4	1.5	85	
SLK011-L1000-S4Q	615 165 255 0	75	<2.5		<70		Tool holsters - DTH42 & DTH TWIN		148				
SLK015-A1000-S4Q	615 165 258 0	75	<2.5		<70		TRA100 1600	615 810 099 0	141				
SLK015-L1000-S4Q	615 165 256 0	75	<2.5		<70		TRA100 2100	615 810 100 0	141				
SLK017-A1000-S4Q	615 165 562 0	75	<2.5		<70		TRA100 2600	615 810 101 0	141				
SLK017-L1000-S4Q	615 165 559 0	75	<2.5		<70		TRA12 1150	615 810 089 0	141				
SLK022-A1000-S4Q	615 165 473 0	75	<2.5		<70		TRA12 1600	615 810 090 0	141				
SLK022-L1000-S4Q	615 165 470 0	75	<2.5		<70		TRA12 2100	615 810 091 0	141				
SLK023-A750-S4Q	615 165 563 0	75	<2.5		<70		TRA200 1600	615 810 102 0	141				
SLK023-L750-S4Q	615 165 560 0	75	<2.5		<70		TRA200 2100	615 810 103 0	141				
SLK029-A530-S4Q	615 165 564 0	75	<2.5		<70		TRA200 2600	615 810 104 0	141				
SLK029-L530-S4Q	615 165 561 0	75	<2.5		<70		TRA25 1150	615 810 092 0	141				
SLK031-A750-S4Q	615 165 474 0	75	<2.5		<70		TRA25 1600	615 810 093 0	141				
SLK031-L750-S4Q	615 165 471 0	75	<2.5		<70		TRA25 2100	615 810 094 0	141				
SLK047-A530-S4Q	615 165 475 0	75	<2.5		<70		TRA25 2600	615 810 095 0	141				
SLK047-L530-S4Q	615 165 472 0	75	<2.5		<70		TRA50 1600	615 810 096 0	141				
SMRD60H	615 170 280 0	247	4.7	1.7	80		TRA50 2100	615 810 097 0	141				
SMRD60HC	615 170 281 0	247	4.7	1.7	82		TRA50 2600	615 810 098 0	141				
SMRD60HV	615 170 282 0	247	4.7	1.7	85		TWINCVI3	615 932 692 0	25				
SP3	615 170 198 0	251	12.6	3.4	80		V100	129504	259				
SP3P	615 170 197 0	251	5.1	2.3	81		Vacuum for drills		182				
SPXRD30H	615 170 332 0	251	8.3	3.2	76		VP2-X	671094	259	1.3	1.1	70	
SV3	615 170 066 0	249	10.7	3.8	80								
SV3-14	615 170 070 0	249	10.7	3.8	82								
SV3-8	615 170 074 0	249	10.7	3.8	78								
SV3P	615 170 067 0	249	10.6	4.0	81								
SV3P14	615 170 071 0	249	10.6	4.0	81								
SV3P8	615 170 075 0	249	7.8	1.3	78								
SV4P	615 170 068 0	249	8.3	3.0	83								
SV4P14	615 170 072 0	249	8.3	3.0	81								
SV4P8	615 170 076 0	249	7.5	3.0	80								
SXOAR1	615 170 233 0	245	6.3	3.0	76								
SXOAR1C	615 170 237 0	245	6.3	3.4	76								
SXOAR1V	615 170 235 0	245	6.3	3.2	82								
SXOAT1	615 170 234 0	245	7.6	3.0	77								
SXOAT1C	615 170 238 0	245	5.3	2.7	78								
SXOAT1V	615 170 236 0	245	5.3	2.7	81								
SXRA35	615 170 218 0	241	5.6	2.1	76								
SXRA35C	615 170 224 0	241	3.8	1.7	78								
SXRA35V	615 170 221 0	241	3.8	1.7	85								
SXRA50	615 170 219 0	241	4.7	2.4	76								
SXRA50C	615 170 225 0	241	3.2	1.4	78								
SXRA50V	615 170 222 0	241	3.2	1.4	85								
SXRA60	615 170 220 0	241	5.0	2.3	76								
SXRA60C	615 170 226 0	241	3.2	1.4	78								
SXRA60V	615 170 223 0	241	4.6	2.9	85								
SXRB35	615 170 209 0	241	3.8	1.7	76								
SXRB35C	615 170 215 0	241	3.4	1.3	78								
SXRB35V	615 170 212 0	241	3.8	1.7	85								
SXRB50	615 170 210 0	241	4.3	1.5	76								

Desoutter Tools follows a policy of continuous product improvement. Specifications and descriptions are thus subject to change without notice.

Check the online ecatalog at www.desouttertools.com for the latest product information.

The key to finding a better way



Desoutter RightWay focuses on six key areas that play an important part in the performance of your production lines.



■ PRODUCTIVITY

Remove bottlenecks to raise workstation productivity and overall line performance.

■ QUALITY

Improve the quality of final goods and reduce quality-related costs by implementing advanced error-proofing solutions that detect and fix defects at the workstation.

■ ERGONOMICS

Reduce work-related musculoskeletal disorders to improve operator morale, cut absenteeism and minimize operator turnover.

■ SAFETY

Fewer on-the-job injuries and the costs associated with lost time and medical costs.

■ ENERGY

Fight rising energy costs by adopting energy-efficient best practices and technologies.

■ PLANNING

Help you accelerate process improvement projects by providing your planning department with valuable resources and expertise.

Desoutter RightWay uses a unique **4-step methodology** to identify workable improvements to your production line. Our solutions combine real-world insights gathered directly from your production line with our unmatched expertise in tool systems for your industry.

Follow-up

IMPLEMENTATION AND SUPPORT

Finally, we work with your line engineers to organize the smooth and timely deployment of the new tool system. Over the life of the system, we will continue to monitor performance and use this feedback to make any adjustments that may be required as your line evolves. We also provide all the preventive maintenance and fixed-price servicing called for in the ROI calculations.

Prove

PROVE THE PAYBACK

Based on the proposed solution, we calculate the return on investment and the payback in terms of the six domains mentioned earlier. We also propose error-proofing solutions, calculate duty cycles and analyze joint quality for assembly applications.

Analyse

ON THE FACTORY FLOOR

Desoutter RightWay begins with a 6-point on-site audit of your entire line, workstations and operator ergonomics. Our expert visits the line with you gathering information and observations about your requirements in the six key domains: productivity, quality, ergonomics, safety, energy consumption and process planning.

Propose

DEMONSTRATING FEASIBILITY

Using the results of our Desoutter RightWay audit, the data you provide and our best practices in similar applications, we design and test a custom solution that is perfectly suited to your requirements. In addition, we demonstrate the solution in real-world conditions to show you first-hand how it resolves your issues and concerns.



More Than Productivity



www.desouttertools.com

USA 615 993 934 8
© Copyright 2013

Printed in Europe - March 2013 - Issue 2